

POWER TRANSISTORS



TO-82

TYPE NO.	PT @ 25°C Watts	MAXIMUM RATINGS				h _{FE}		Sat V Voltages @				Test Conditions		I _{EB0} * ma
		BV _{CB0}	BV _{CE0}	BV _{EB0}	I _c	MIN	MAX	I _c	V _{CE}	V _{CE}	V _{BE}	I _c	I _B	
		V	V	V	A			A	V	V	V	A	A	
2N1015	150	30	30	25	7.5	10		2	4	1.5	2	2	.3	20
2N1015A	150	60	60	25	7.5	10		2	4	1.5	2	2	.3	20
2N1015B	150	100	100	25	7.5	10		2	4	1.5	2	2	.3	20
2N1015C	150	150	150	25	7.5	10		2	4	1.5	2	2	.3	20
2N1015D	150	200	200	25	7.5	10		2	4	1.5	2	2	.3	20
2N1015E	150	250	250	25	7.5	10		2	4	1.5	2	2	.3	20
2N1015F	150	300	300	25	7.5	10		2	4	1.5	2	2	.3	20
2N1016	150	30	30	25	7.5	10		5	4	2.5	4	5	.750	20
2N1016A	150	60	60	25	7.5	10		5	4	2.5	4	5	.750	20
2N1016B	150	100	100	25	7.5	10		5	4	2.5	4	5	.750	20
JAN2N1016B	150	100	100	25	7.5	10	35	5	4	2.5	4	5	.750	20
2N1016C	150	150	150	25	7.5	10		5	4	2.5	4	5	.750	20
JAN2N1016C	150	150	150	25	7.5	10	35	5	4	2.5	4	5	.750	20
2N1016D	150	200	200	25	7.5	10		5	4	2.5	4	5	.750	20
JAN2N1016D	150	200	200	25	7.5	10	35	5	4	2.5	4	5	.750	20
2N1016E	150	250	250	25	7.5	10		5	4	2.5	4	5	.750	20
2N1016F	150	300	300	25	7.5	10		5	4	2.5	4	5	.750	20

TYPE NO.	PT @ 75°C Watts	MAXIMUM RATINGS				h _{FE}		Sat V Voltages @				Test Conditions		I _{EB0} ** ma
		BV _{CB0}	BV _{CE0}	BV _{EB0}	I _c	MIN	MAX	I _c	V _{CE}	V _{CE}	V _{BE}	I _c	I _B	
		V	V	V	A			A	V	V	V	A	A	
2N2739	200*	50	50	15	20	10		10	4	1.5	2.5	10	2	25
2N2740	200*	100	100	15	20	10		10	4	1.5	2.5	10	2	25
2N2741	200*	150	150	15	20	10		10	4	1.5	2.5	10	2	25
2N2742	200*	200	200	15	20	10		10	4	1.5	2.5	10	2	25
2N2745	200*	50	50	15	20	10		15	4	1.5	2.5	15	3	25
2N2746	200*	100	100	15	20	10		15	4	1.5	2.5	15	3	25
2N2747	200*	150	150	15	20	10		15	4	1.5	2.5	15	3	25
2N2748	200*	200	200	15	20	10		15	4	1.5	2.5	15	3	25
2N2751†	200*	50	50	15	20	10		20	4	1.5	2.5	20	4	25
2N2752†	200*	100	100	15	20	10		20	4	1.5	2.5	20	4	25
2N2753†	200*	150	150	15	20	10		20	4	1.5	2.5	20	4	25

*T_c = 75°C

**T_A = 150°C

†TO-82 pkg. with 60 MIL DIA. PINS.

Solid Power Corporation

0043592 0000428 770

CASE OUTLINES

TO-3

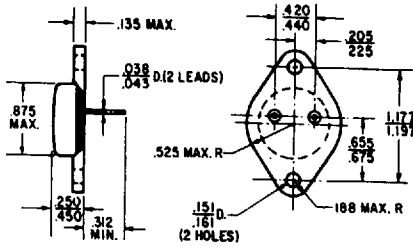

TO-57

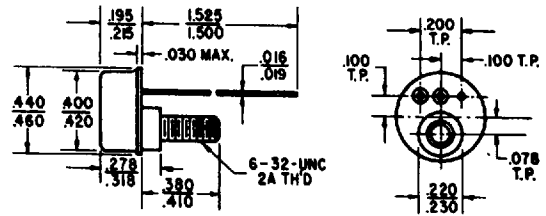

TO-8

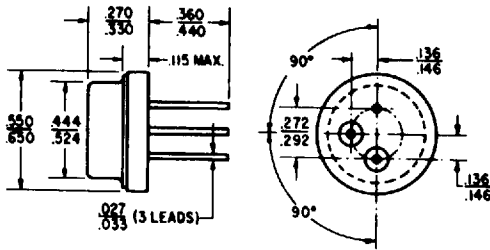

TO-59

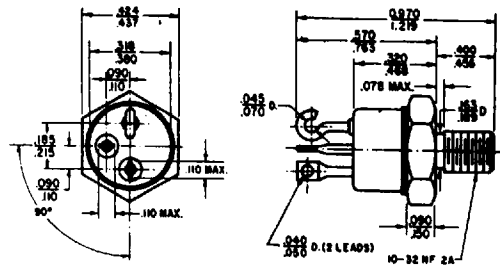

TO-5

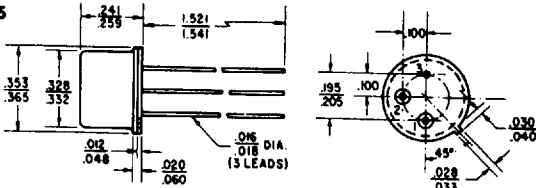

TO-81

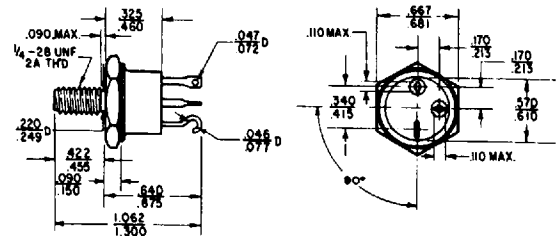

TO-36

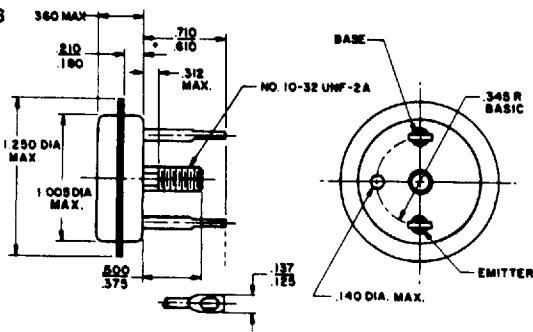

TO-63

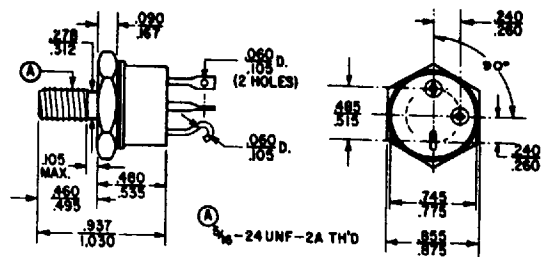

TO-53

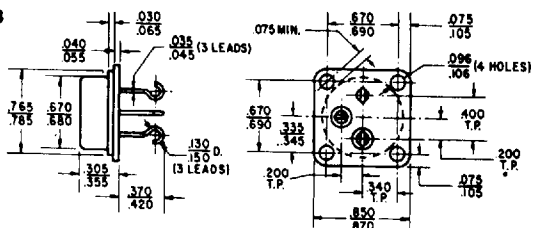

TO-82

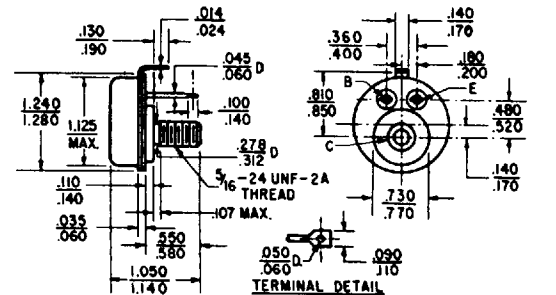

TO-114

