

STANDARD RECOVERY DIODES

Hockey Puk Version

Features

- Wide current range
- High voltage ratings up to 4500V
- High surge current capabilities
- Diffused junction
- Hockey Puk version
- Case style DO-200AB (B-PUK)

Typical Applications

- Converters
- Power supplies
- High power drives
- Auxiliary system supplies for traction applications

700A

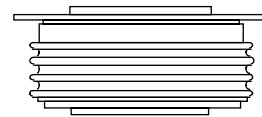

case style DO-200AB (B-PUK)

Major Ratings and Characteristics

Parameters	SD700C..L	Units
$I_{F(AV)}$	700	A
@ T_{hs}	55	°C
$I_{F(RMS)}$	1310	A
@ T_{hs}	25	°C
I_{FSM}	@ 50Hz 7500	A
	@ 60Hz 7850	A
I^2t	@ 50Hz 281	KA ² s
	@ 60Hz 257	KA ² s
V_{RRM} range	3000 to 4500	V
T_J	- 40 to 150	°C

SD700C..L Series

Bulletin I2096 rev. B 04/00

International
 Rectifier

ELECTRICAL SPECIFICATIONS

Voltage Ratings

Type number	Voltage Code	V_{RRM} , maximum repetitive peak reverse voltage V	V_{RSM} , maximum non-repetitive peak rev. voltage V	I_{RRM} max. @ $T_J = T_J$ max. mA
SD700C..L	30	3000	3100	50
	36	3600	3700	
	40	4000	4100	
	45	4500	4600	

Forward Conduction

Parameter	SD700C..L	Units	Conditions
$I_{F(AV)}$ Max. average forward current @ Heatsink temperature	700 (345)	A	180° conduction, half sine wave
	55 (85)	°C	Double side (single side) cooled
$I_{F(RMS)}$ Max. RMS forward current	1310	A	@ 25°C heatsink temperature double side cooled
I_{FSM} Max. peak, one-cycle forward, non-repetitive surge current	7500	A	t = 10ms No voltage reappplied
	7850		t = 8.3ms
	6310		t = 10ms 50% V_{RRM} reappplied
	6600		t = 8.3ms
I^2t Maximum I^2t for fusing	281	KA ² s	t = 10ms No voltage reappplied
	257		t = 8.3ms
	199		t = 10ms 50% V_{RRM} reappplied
	182		t = 8.3ms
$I^2\sqrt{t}$ Maximum $I^2\sqrt{t}$ for fusing	2810	KA ² √s	t = 0.1 to 10ms, no voltage reappplied
$V_{F(TO)1}$ Low level value of threshold voltage	0.88	V	(16.7% x π x $I_{F(AV)} < I < \pi$ x $I_{F(AV)}$), $T_J = T_J$ max.
$V_{F(TO)2}$ High level value of threshold voltage	0.99		($I > \pi$ x $I_{F(AV)}$), $T_J = T_J$ max.
r_{f1} Low level value of forward slope resistance	0.78	mΩ	(16.7% x π x $I_{F(AV)} < I < \pi$ x $I_{F(AV)}$), $T_J = T_J$ max.
r_{f2} High level value of forward slope resistance	0.73		($I > \pi$ x $I_{F(AV)}$), $T_J = T_J$ max.
V_{FM} Max. forward voltage drop	1.66	V	$I_{pk} = 1000A$, $T_J = T_J$ max, $t_p = 10ms$ sinusoidal wave

Thermal and Mechanical Specifications

Parameter	SD700C..L	Units	Conditions
T _J Max. junction operating temperature range	-40 to 150	°C	
T _{stg} Max. storage temperature range	-55 to 200		
R _{thJ-hs} Max. thermal resistance, junction to heatsink	0.11 0.05	K/W	DC operationsingle side cooled DC operationdouble side cooled
F Mounting force, ± 10%	9800 (1000)	N (Kg)	
wt Approximate weight	250	g	
Case style	DO-200AB(B-PUK)		See Outline Table

ΔR_{thJ-hs} Conduction

(The following table shows the increment of thermal resistance R_{thJ-hs} when devices operate at different conduction angles than DC)

Conduction angle	Sinusoidal conduction		Rectangular conduction		Units	Conditions
	Single Side	Double Side	Single Side	Double Side		
180°	0.011	0.011	0.008	0.008	K/W	T _J = T _J max.
120°	0.014	0.015	0.014	0.014		
90°	0.018	0.018	0.019	0.019		
60°	0.026	0.026	0.027	0.028		
30°	0.045	0.046	0.046	0.046		

Ordering Information Table

Device Code

SD	70	0	C	45	L
①	②	③	④	⑤	⑥

- 1** - Diode
- 2** - Essential part number
- 3** - 0 = Standard recovery
- 4** - C = Ceramic Puk
- 5** - Voltage code: code x 100 = V_{RRM} (see Voltage Ratings Table)
- 6** - L = Puk Case DO-200AB (B-PUK)

SD700C..L Series

Bulletin I2096 rev. B 04/00

Outline Table

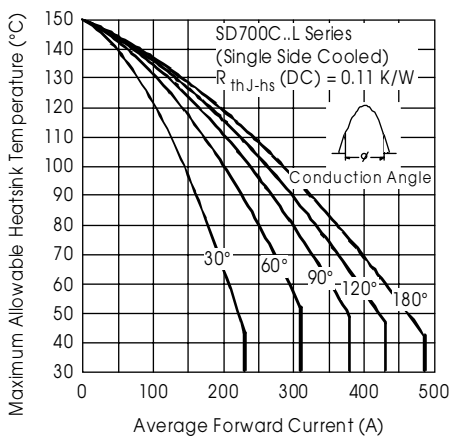
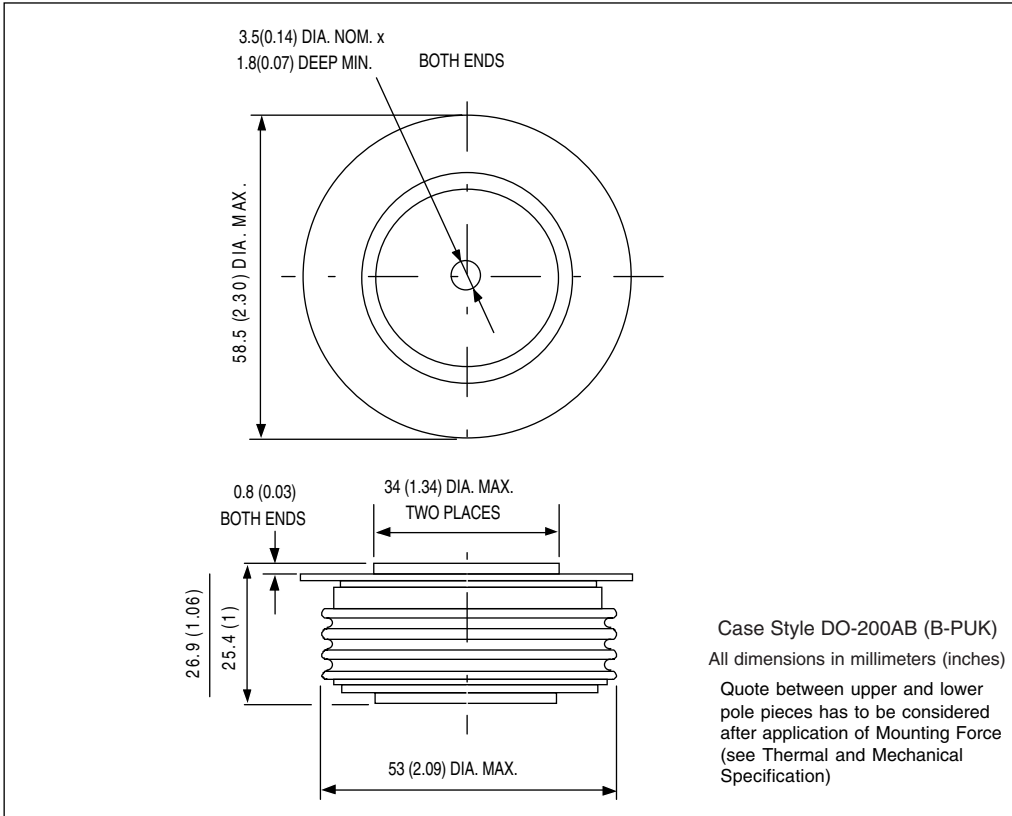

Fig. 1 - Current Ratings Characteristics

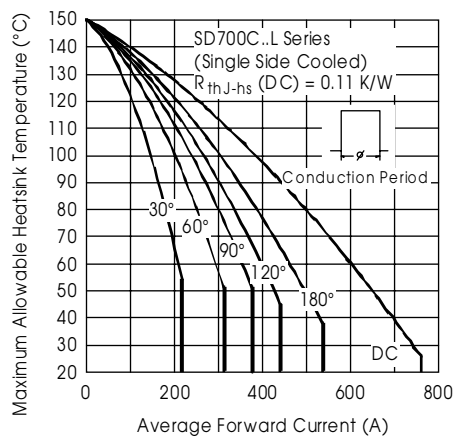

Fig. 2 - Current Ratings Characteristics

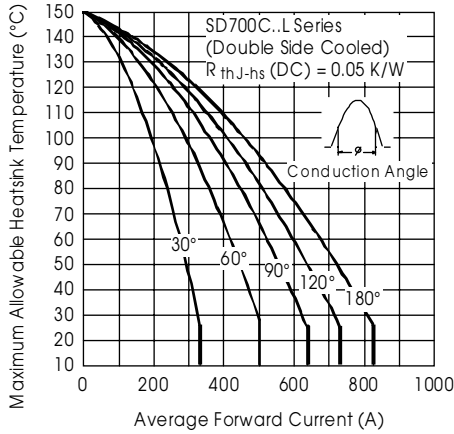

Fig. 3 - Current Ratings Characteristics

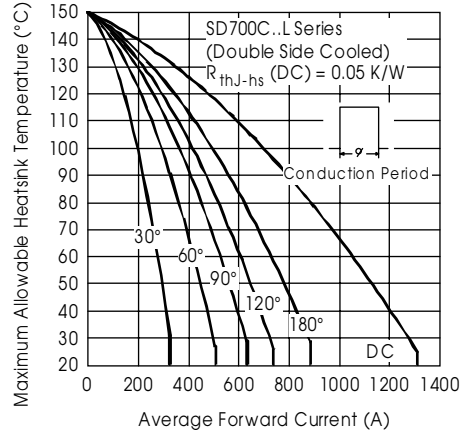

Fig. 4 - Current Ratings Characteristics

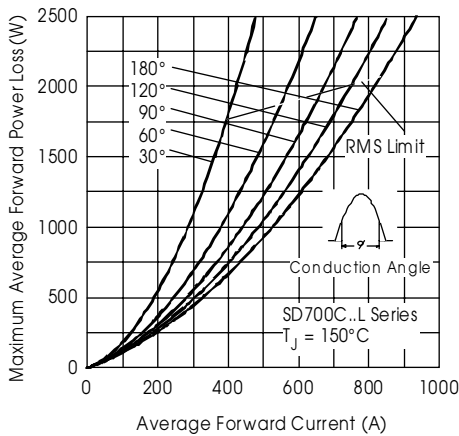

Fig. 5 - Forward Power Loss Characteristics

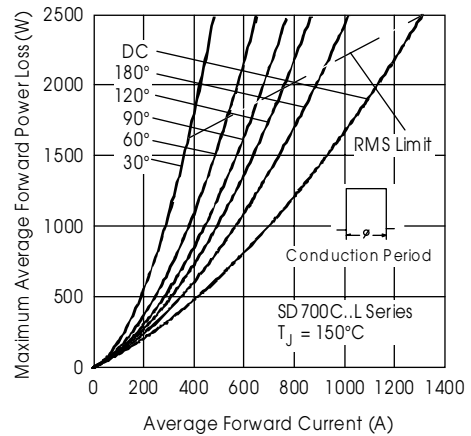

Fig. 6 - Forward Power Loss Characteristics

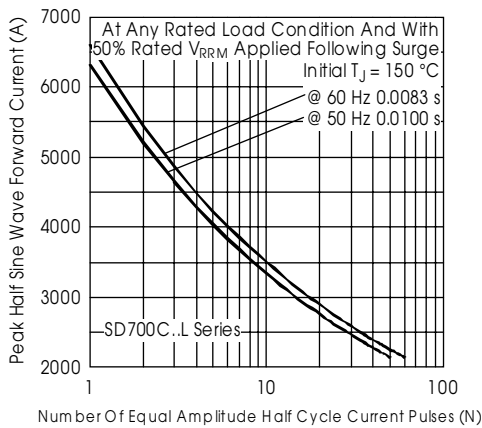

Fig. 7 - Maximum Non-Repetitive Surge Current
Single and Double Side Cooled

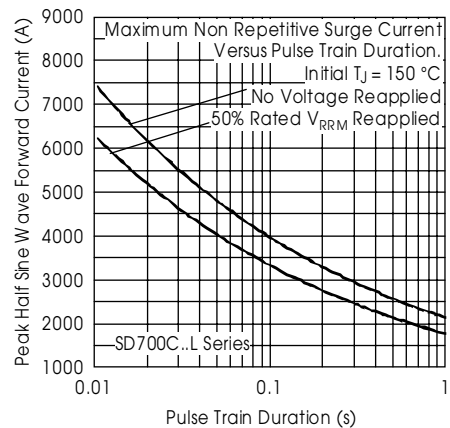

Fig. 8 - Maximum Non-Repetitive Surge Current
Single and Double Side Cooled

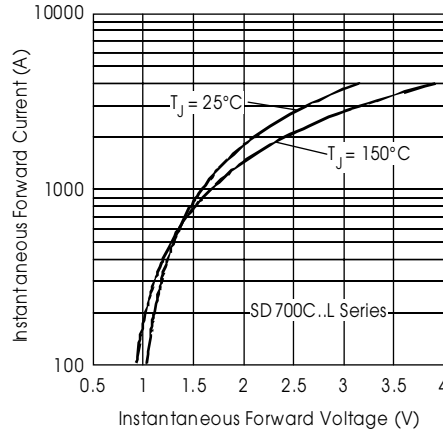

Fig. 9 - Forward Voltage Drop Characteristics

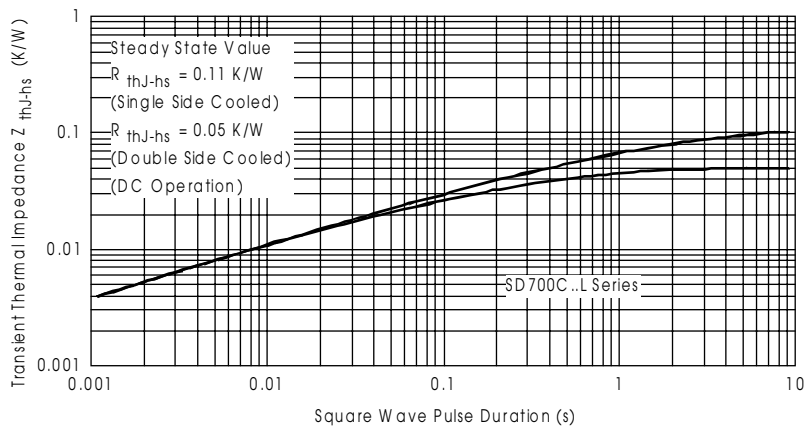

Fig. 10 - Thermal Impedance Z_{thJ-hs} Characteristics