



Micro Commercial Components

Micro Commercial Components
20736 Marilla Street Chatsworth
CA 91311
Phone: (818) 701-4933
Fax: (818) 701-4939

SMCJ5.0(C)A THRU SMCJ440(C)A

Features

- For surface mount application in order to optimize board space
- Low inductance
- Low profile package
- Built-in strain relief
- Glass passivated junction
- Typical I_D less than 1uA above 10V
- High temperature soldering: 260°C/10 seconds at terminals
- Plastic package has Underwrites Laboratory Flammability Classification 94V-O
- UL Recognized File # E222849
- For Bidirectional Devices Add "C" To The Suffix Of The Part Number: i.e.SMCJ5.0CA for 5% Tolerance

Transient Voltage Suppressor 5.0 to 440 Volts 1500 Watt

DO-214AB (SMC) (LEAD FRAME)

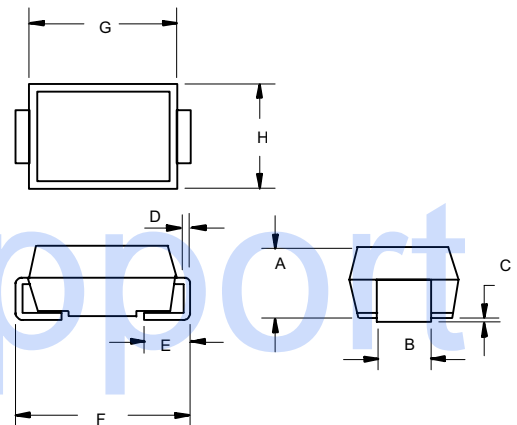

DIM	INCHES		MM		NOTE
	MIN	MAX	MIN	MAX	
A	.079	.103	2.00	2.62	
B	.108	.128	2.75	3.25	
C	.002	.008	0.051	0.203	
D	.006	.012	0.152	0.305	
E	.030	.050	0.76	1.27	
F	.305	.320	7.75	8.13	
G	.260	.280	6.60	7.11	
H	.220	.245	5.59	6.22	

Mechanical Data

- CASE: JEDEC DO-214AB molded plastic body over passivated junction
- Terminals: solderable per MIL-STD-750, Method 2026
- Polarity: Color band denotes positive end(cathode) except Bi-directional types.
- Standard packaging: 16mm tape per (EIA 481).
- Weight: 0.007 ounce, 0.21 gram

Maximum Ratings @ 25°C Unless Otherwise Specified

Peak Pulse Current on 10/1000us waveform(Note1, Fig3)	I_{PPM}	See Table 1	Amps
Peak Pulse Power Dissipation on 10/1000us waveform(Note1,2, Fig1)	P_{PPM}	Minimum 1500	Watts
Peak forward surge current (JEDEC Method) (Note 2,3)	I_{FSM}	200.0	Amps
Operation And Storage Temperature Range	T_J , T_{STG}	-55°C to +150°C	

SUGGESTED SOLDER PAD LAYOUT

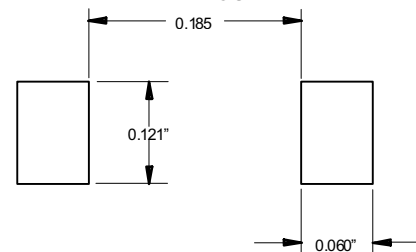

NOTES:

1. Non-repetitive current pulse per Fig.3 and derated above $T_A=25^\circ\text{C}$ per Fig.2.
2. Mounted on 8.0mm² copper pads to each terminal.
3. 8.3ms, single half sine-wave or equivalent square wave, duty cycle=4 pulses per. Minutes maximum.

SMCJ5.0 THRU SMCJ440CA

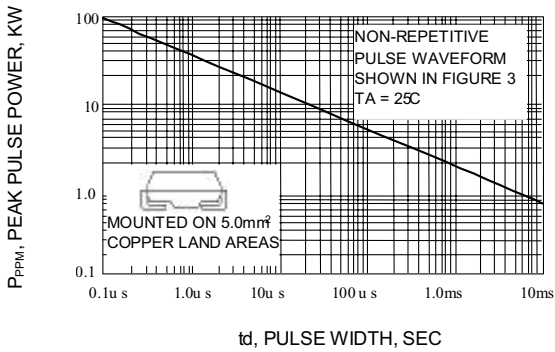

Fig. 1-PEAK PULSE POWER RATING CURVE

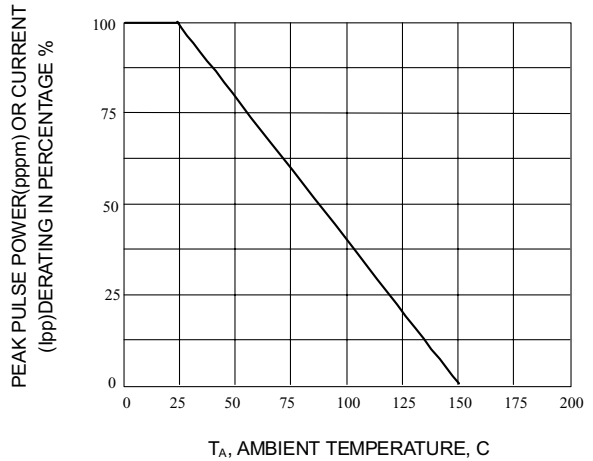

Fig. 2-PULSE DERATING CURVE

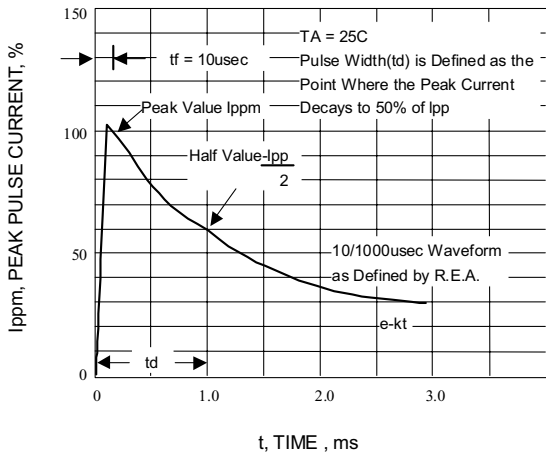

Fig. 3-PULSE WAVEFORM

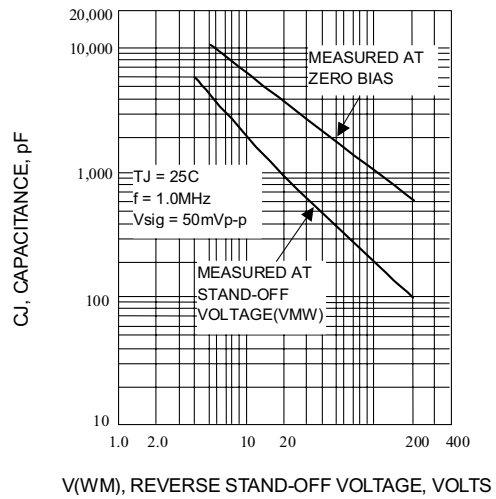

Fig. 4-TYPICAL JUNCTION CAPACITANCE

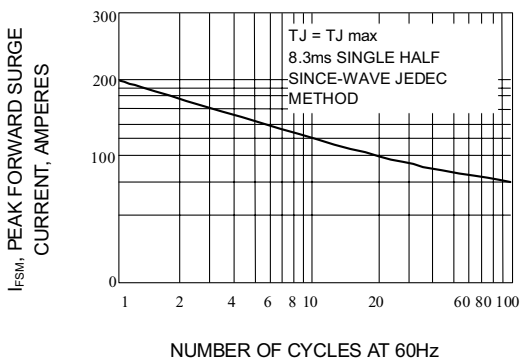

Fig. 5-MAXIMUM NON-REPETITIVE PEAK FORWARD SURGE CURRENT

SMCJ5.0 THRU SMCJ440CA



Micro Commercial Components

ELECTRICAL CHARACTERISTICS @25°C

MCC Part Number		Reverse Stand -Off Voltage	Breakdown Voltage $V_{BR}(V)$		Test Current	Max. Clamping Voltage @ I_{PP}	Peak Pulse Current	Reverse Leakage Current@ V_{WM}	Marking Code	
Uni-Polar	Bi-Polar	$V_{WM}(V)$	Min	Max	$I_T(mA)$	$V_C(V)$	$I_{PP}(A)$	$I_D(\mu A)$	UNI	BI
SMCJ5.0A	SMCJ5.0CA	5	6.4	7.0	10	9.2	163.0	800	GDE	BDE
SMCJ6.0A	SMCJ6.0CA	6	6.7	7.4	10	10.3	145.7	800	GDG	BDG
SMCJ6.5A	SMCJ6.5CA	6.5	7.2	8.0	10	11.2	134.0	500	GDK	BDK
SMCJ7.0A	SMCJ7.0CA	7	7.8	8.6	10	12.0	125.0	200	GDM	BDM
SMCJ7.5A	SMCJ7.5CA	7.5	8.3	9.2	1	12.9	116.3	100	GDP	BDP
SMCJ8.0A	SMCJ8.0CA	8	8.9	9.8	1	13.6	110.3	50	GDR	BDR
SMCJ8.5A	SMCJ8.5CA	8.5	9.4	10.4	1	14.4	104.2	20	GDT	BDT
SMCJ9.0A	SMCJ9.0CA	9	10.0	11.1	1	15.4	97.4	10	GDV	BDV
SMCJ10A	SMCJ10CA	10	11.1	12.3	1	17.0	88.3	5	GDY	BDY
SMCJ11A	SMCJ11CA	11	12.2	13.5	1	18.2	82.5	5	GDZ	BDZ
SMCJ12A	SMCJ12CA	12	13.3	14.7	1	19.9	75.4	5	GEE	BEE
SMCJ13A	SMCJ13CA	13	14.4	15.9	1	21.5	69.8	5	GEG	BEG
SMCJ14A	SMCJ14CA	14	15.6	17.2	1	23.2	64.7	5	GEK	BEK
SMCJ15A	SMCJ15CA	15	16.7	18.5	1	24.4	61.5	5	GEM	BEM
SMCJ16A	SMCJ16CA	16	17.8	19.7	1	26.0	57.7	5	GEP	BEP
SMCJ17A	SMCJ17CA	17	18.9	20.9	1	27.6	54.4	5	GER	BER
SMCJ18A	SMCJ18CA	18	20.0	22.1	1	29.2	51.4	5	GET	BET
SMCJ20A	SMCJ20CA	20	22.2	24.5	1	32.4	46.3	5	GEV	BEV
SMCJ22A	SMCJ22CA	22	24.4	26.9	1	35.5	42.3	5	GEX	BEX
SMCJ24A	SMCJ24CA	24	26.7	29.5	1	38.9	38.6	5	GEZ	BEZ
SMCJ26A	SMCJ26CA	26	28.9	31.9	1	42.1	35.7	5	GFE	BFE
SMCJ28A	SMCJ28CA	28	31.1	34.4	1	45.4	33.1	5	GFG	BFG
SMCJ30A	SMCJ30CA	30	33.3	36.8	1	48.4	31.0	5	GFK	BFK
SMCJ33A	SMCJ33CA	33	36.7	40.6	1	53.3	28.2	5	GFM	BFM
SMCJ36A	SMCJ36CA	36	40.0	44.2	1	58.1	25.9	5	GFP	BFP
SMCJ40A	SMCJ40CA	40	44.4	49.1	1	64.5	23.3	5	GFR	BFR
SMCJ43A	SMCJ43CA	43	47.8	52.8	1	69.4	21.7	5	GFT	BFT
SMCJ45A	SMCJ45CA	45	50.0	55.3	1	72.7	20.6	5	GFV	BFV
SMCJ48A	SMCJ48CA	48	53.3	58.9	1	77.4	19.4	5	GFX	BFX
SMCJ51A	SMCJ51CA	51	56.7	62.7	1	82.4	18.2	5	GFZ	BFZ
SMCJ54A	SMCJ54CA	54	60.0	66.3	1	87.1	17.3	5	GGE	BGE
SMCJ58A	SMCJ58CA	58	64.4	71.2	1	93.6	16.1	5	GGG	BGG
SMCJ60A	SMCJ60CA	60	66.7	73.7	1	96.8	15.5	5	GGK	BGK
SMCJ64A	SMCJ64CA	64	71.1	78.6	1	103.0	14.6	5	GGM	BGM
SMCJ70A	SMCJ70CA	70	77.8	86.0	1	113.0	13.3	5	GGP	BGP
SMCJ75A	SMCJ75CA	75	83.3	92.1	1	121.0	12.4	5	GGR	BGR
SMCJ78A	SMCJ78CA	78	86.7	95.8	1	126.0	11.9	5	GGT	BGT
SMCJ85A	SMCJ85CA	85	94.4	104.0	1	137.0	11.0	5	GGV	BGV
SMCJ90A	SMCJ90CA	90	100.0	111.0	1	146.0	10.3	5	GGX	BGX
SMCJ100A	SMCJ100CA	100	111.0	123.0	1	162.0	9.3	5	GGZ	BGZ

For bi-directional type having V_{RWM} of 10volts and less, the IR limit is double. For parts without A, the VBR is $\pm 10\%$

SMCJ5.0 THRU SMCJ440CA



Micro Commercial Components

ELECTRICAL CHARACTERISTICS @25°C

MCC Part Number		Reverse Standard - Off Voltage	Breakdown Voltage $V_{BR}(V)$		Test Current	Max. Clamping Voltage @ I_{PP}	Peak Pulse Current	Reverse Leakage Current@ V_{WM}	Marking Code	
Uni-Polar	Bi-Polar	$V_{WM}(V)$	Min	Max	$I_T(mA)$	$V_C(V)$	$I_{PP}(A)$	$I_D(\mu A)$	UNI	BI
SMCJ110A	SMCJ110CA	110	122.0	135.0	1	177	8.5	5	GHE	BHE
SMCJ120A	SMCJ120CA	120	133.0	147.0	1	193	7.8	5	GHG	BHG
SMCJ130A	SMCJ130CA	130	144.0	159.0	1	209	7.2	5	GHK	BHK
SMCJ150A	SMCJ150CA	150	167.0	185.0	1	243	6.2	5	GHM	BHM
SMCJ160A	SMCJ160CA	160	178.0	197.0	1	259	5.8	5	BHP	BHP
SMCJ170A	SMCJ170CA	170	189.0	209.0	1	275	5.5	5	GHR	BHR
SMCJ180A	SMCJ180CA	180	201.0	222.0	1	292	5.1	5	GHT	BHT
SMCJ200A	SMCJ200CA	200	224.0	247.0	1	324	4.6	5	GHV	BHV
SMCJ220A	SMCJ220CA	220	246.0	272.0	1	356	4.2	5	GHX	BHX
SMCJ250A	SMCJ250CA	250	279.0	309.0	1	405	3.7	5	GHZ	BHZ
SMCJ300A	SMCJ300CA	300	335.0	371.0	1	486	3.1	5	GJE	BJE
SMCJ350A	SMCJ350CA	350	391.0	432.0	1	567	2.6	5	GJG	BJG
SMCJ400A	SMCJ400CA	400	447.0	494.0	1	648	2.3	5	GJK	BJK
SMCJ440A	SMCJ440CA	440	492.0	543.0	1	713	2.1	5	GJM	BJM

For bi-directional type having V_{RWM} of 10volts and less, the IR limit is double. For parts without A, the VBR is $\pm 10\%$



Micro Commercial Components

*****IMPORTANT NOTICE*****

Micro Commercial Components Corp. reserves the right to make changes without further notice to any product herein to make corrections, modifications, enhancements, improvements, or other changes. *Micro Commercial Components Corp.* does not assume any liability arising out of the application or use of any product described herein; neither does it convey any license under its patent rights, nor the rights of others. The user of products in such applications shall assume all risks of such use and will agree to hold *Micro Commercial Components Corp.* and all the companies whose products are represented on our website, harmless against all damages.

*****APPLICATIONS DISCLAIMER*****

Products offer by *Micro Commercial Components Corp.* are not intended for use in Medical, Aerospace or Military Applications.