



#### INDOOR UNIT

ASH070VE/D  
ASH090VE/D  
ASH120VE/D  
ASH071VE/D  
ASH091VE/D  
ASH121VE/D  
ASH074VE/D  
ASH094VE/D  
ASH124VE/D  
ASH075VE/D  
ASH095VE/D  
ASH125VE/D

#### OUTDOOR UNIT

AXH070VE/D  
AXH090VE/D  
AXH120VE/D  
AXH071VE/D  
AXH091VE/D  
AXH121VE/D  
AXH074VE/D  
AXH094VE/D  
AXH124VE/D  
AXH075VE/D  
AXH095VE/D  
AXH125VE/D

# SERVICE Manual

PDF Support

## AIR CONDITIONER

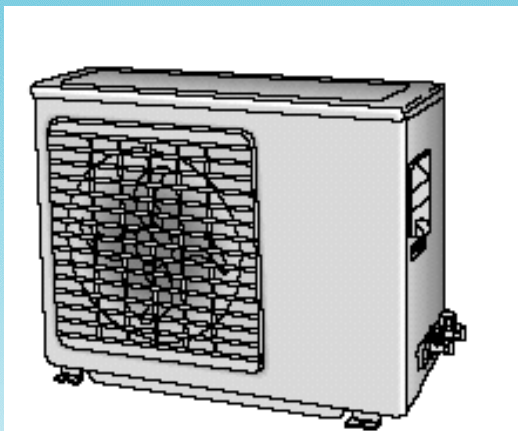
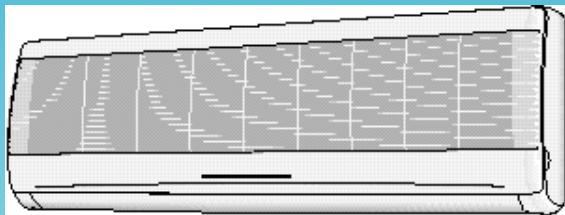

## CONTENTS

1. Precautions
2. Product Specifications
3. Operating Instructions and Installation
4. Disassembly and Reassembly
5. Troubleshooting
6. Exploded Views and Parts List
7. Block Diagrams
8. PCB Diagrams
9. Wiring Diagrams
10. Schematic Diagrams

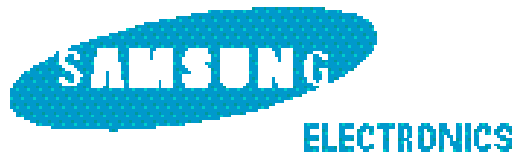

# 1. Precautions

1. **Warning:** Prior to repair, disconnect the power cord from the circuit breaker.
2. **Use proper parts:** Use only exact replacement parts. (Also, we recommend replacing parts rather than repairing them.)
3. **Use the proper tools:** Use the proper tools and test equipment, and know how to use them. Using defective tools or test equipment may cause problems later-intermittent contact, for example.
4. **Power Cord:** Prior to repair, check the power cord and replace it if necessary.
5. **Avoid using an extension cord, and avoid tapping into a power cord.** This practice may result in malfunction or fire.
6. **After completing repairs and reassembly, check the insulation resistance.** Procedure: Prior to applying power, measure the resistance between the power cord and the ground terminal. The resistance must be greater than 30 megohms.
7. **Make sure that the grounds are adequate.**
8. **Make sure that the installation conditions are satisfactory.** Relocate the unit if necessary.
9. **Keep children away from the unit while it is being repaired.**
10. **Be sure to clean the unit and its surrounding area.**

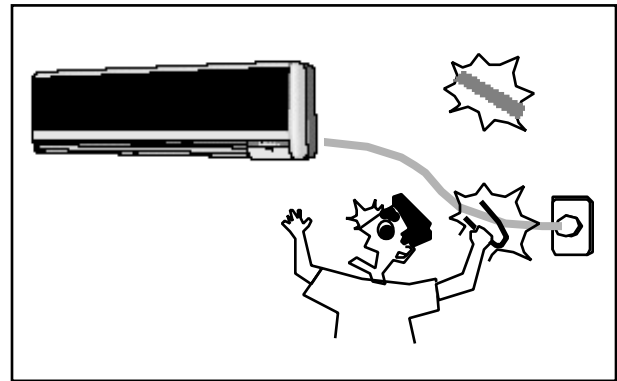

Fig. 1-1 Avoid Dangerous Contact

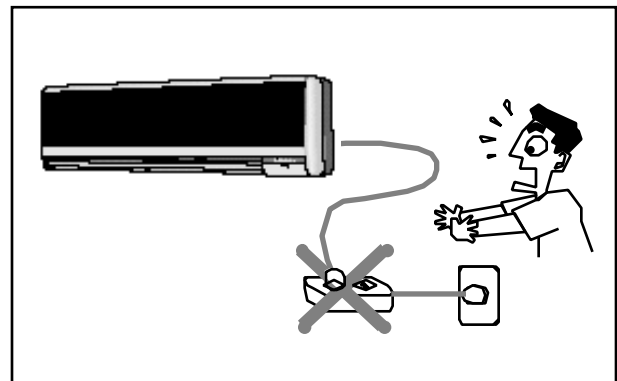

Fig. 1-2 No Tapping and No Extension Cords

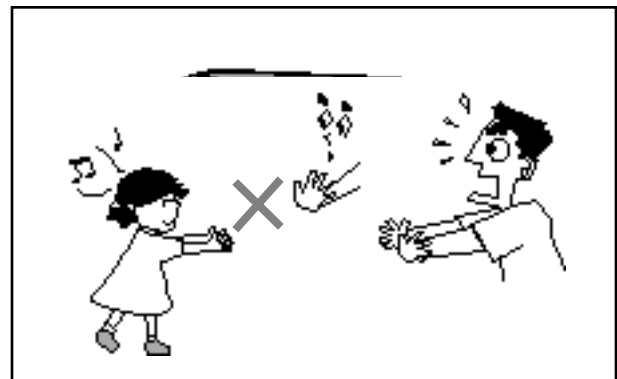

Fig. 1-3 No Kids Nearby!

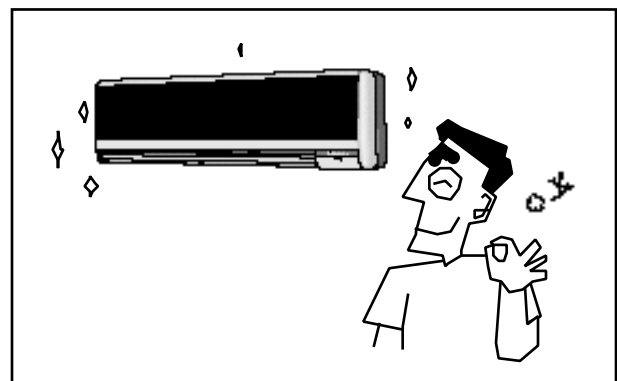

Fig. 1-4 Clean the Unit

# MEMO

## 2. Product Specifications

### 2-1 Table

Item		Model	ASH070VE/ASH071VE/ASH074VE/ASH075VE		ASH090VD/ASH091VD/ASH094VD/ASH095VD		ASH090VE/ASH091VE/ASH094VE/ASH095VE		ASH090VD/ASH091VD/ASH094VD/ASH095VD		ASH120VE/ASH121VE/ASH124VE/ASH125VE		ASH120VD/ASH121VD/ASH124VD/ASH125VD			
			Indoor unit	Outdoor unit	Indoor unit	Outdoor unit	Indoor unit	Outdoor unit	Indoor unit	Outdoor unit	Indoor unit	Outdoor unit	Indoor unit	Outdoor unit		
Type		-	Wall-mounting		Wall-mounting		Wall-mounting		Wall-mounting		Wall-mounting		Wall-mounting			
Performance	Cooling	BTU/h	7000		7000		9000		9000		12000		12000			
	Dehumidifying	l/h	1.2		1.2		1.6		1.6		1.9		1.9			
	Heating	BTU/h	7500		7500		10000		10000		13000		13000			
	Low temp. heating	BTU/h	-		-		-		-		-		-			
	Air volume	Cooling	m <sup>3</sup> /min	6.0		6.0		6.1		6.1		7.8		7.8		
		Heating	m <sup>3</sup> /min	6.2		6.2		6.9		6.9		8.2		8.2		
	Noise	Cooling	dB	35	45	35	45	35	45	35	45	38	49	38	49	
		Heating	dB	35	45	35	45	35	45	35	45	38	49	38	49	
	Energy efficiency ratio	Cooling	BTU/h.W	10.6		10.6		10.1		10.1		10.2		9.83		
Heating		BTU/h.W	12.1		11.7		10.7		10.7		10.8		10.4			
Power	V-Hz	1-220 / 240-50		1-200 / 220-50		1-220 / 240-50		1-220 / 220-50		1-220 / 240-50		1-200 / 220-50				
Power	Power Consumption	Cooling	W		660		660		890		890		1180			
		Heating	W		620		640		930		930		1200			
	operating Current	Cooling	A		2.8		3.3		4.0		4.2		5.0			
		Heating	A		2.7		3.2		4.0		4.2		5.2			
	Power factor	Cooling	%		98.2		90.9		92.7		96.3		98.3			
		Heating	%		95.7		90.9		96.9		99.9		96.2			
	Starting current	A		17.0		17.0		22.0		22.0		30.0		36.0		
	Power cord	Length	m		2		-		2		-		2		-	
		Number of core wire			250V 10/16A		250V 10/16A		250V 10/16A		250V 10/16A		250V 10/16A		250V 10/16A	
Fuse capacity	A		3.15		-		3.15		-		3.15		-			
Outer dimension	Width x Height x Depth	mm	815x298x182	720x525x245	185x298x182	720x525x245	815x298x182	720x525x245	185x298x182	720x525x245	815x298x182	720x525x245	185x298x182	720x525x245		
		inch	32.08x11.73x7.17	28.35x20.67x9.65	32.08x11.73x7.17	28.35x20.67x9.65	32.08x11.73x7.17	28.35x20.67x9.65	32.08x11.73x7.17	28.35x20.67x9.65	32.08x11.73x7.17	28.35x20.67x9.65	32.08x11.73x7.17	28.35x20.67x9.65		
Weight	kg		9.6		28		9.6		28		9.6		32			
Refrigerant pipe	Liquid	OD(mm)x L(m)		ø6.35 x 5		ø6.35 x 5		ø6.35 x 5		ø6.35 x 5		ø6.35 x 5				
	GAS			ø9.52 x 5		ø9.52 x 5		ø9.52 x 5		ø9.52 x 5		ø12.7 x 5				
Drain hose	ID(mm)x L(m)		ø17 x 2000		ø17 x 2000		ø17 x 2000		ø17 x 2000		ø17 x 2000		ø17 x 2000			
Compressor	Type			-		Rotary		-		Rotary		-		Rotary		
	Motor	Type			-		-		-		-		-			
		Rated output	W		-		675		-		895		-		1215	
Blower	Type			Cross-fan		Propeller		Cross-fan		Propeller		Cross-fan		Propeller		
	Motor	Type			Resin		Die casting		Resin		Steel		Resin		Steel	
		Rated output	W		35		20		35		20		35		20	
Heat exchanger			2Row 12Step		1Row 20Step		2Row 12Step		1Row 20Step		2Row 12Step		1Row 20Step			
Refrigerant control unit			CAPILLARY TUBE		CAPILLARY TUBE		CAPILLARY TUBE		CAPILLARY TUBE		CAPILLARY TUBE		CAPILLARY TUBE			
Freezer oil capacity			280		280		360		360		410		410			
Refrigerant to change(R-22)			690		695		760		820		920		920			
Protection device			-		MST24AMN -12008		-		MST24AMM -12008		-		MRA12037 -12007			
Cooling test Condition			INDOOR UNIT : DB27°C WB19°C						OUTDOOR UNIT : DB35°C WB24°C							
Heating test Condition			INDOOR UNIT : DB20°C						OUTDOOR UNIT : DB7°C WB 6°C							
Maximum operation Condition			INDOOR UNIT : DB32°C WB22.5°C						OUTDOOR UNIT : DB43°C WB25.5°C							

## 2-2 Dimensions

### 2-2-1 Indoor Unit

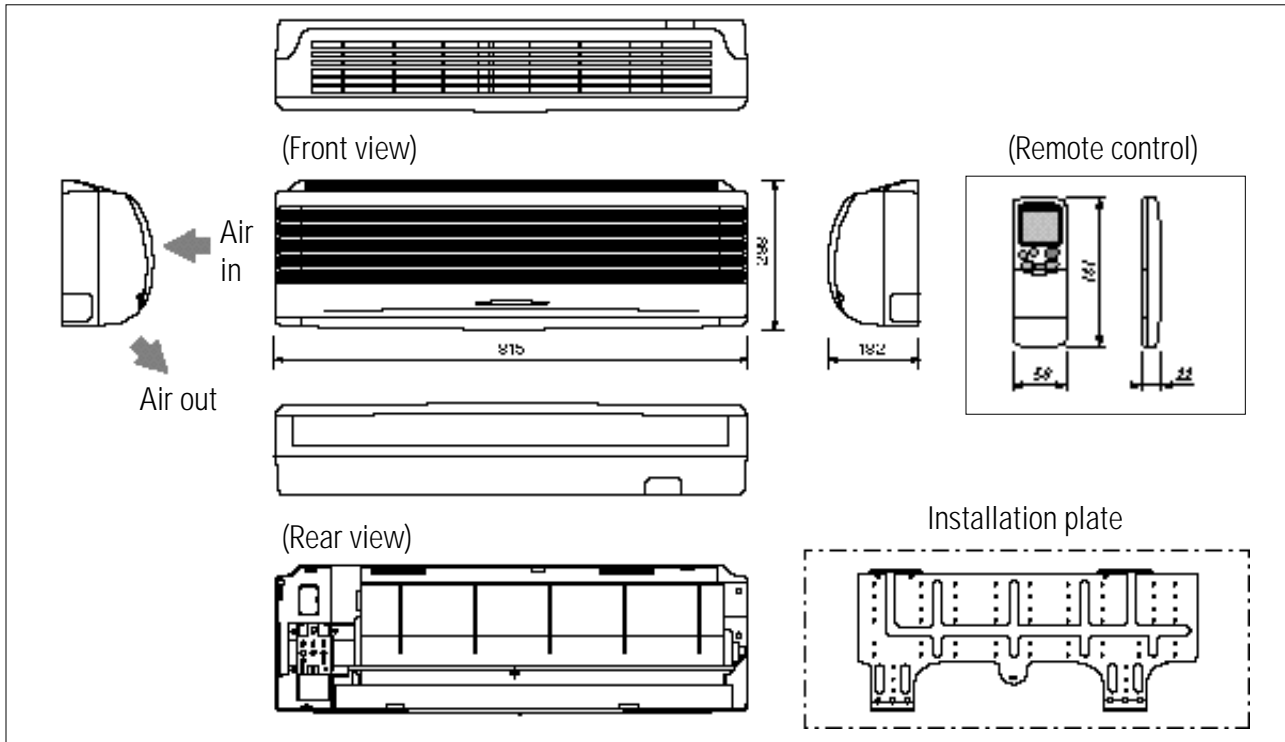

### 2-2-1 Outdoor Unit

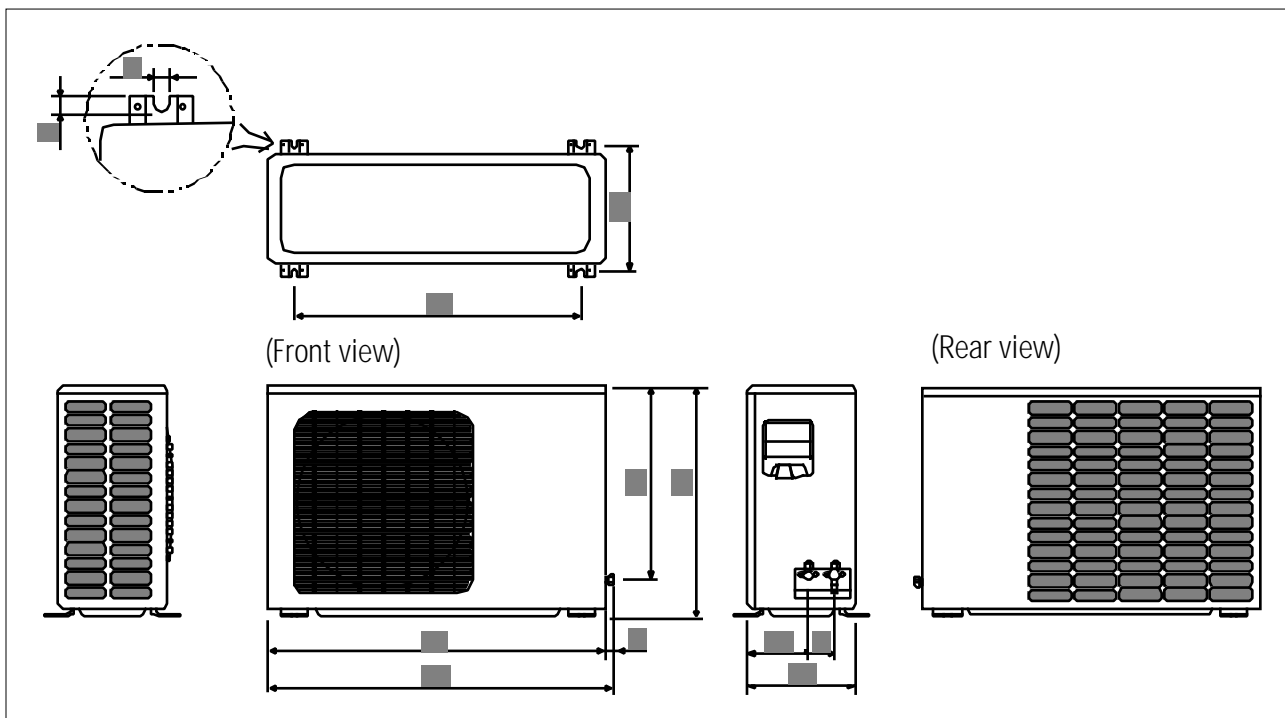

## 2-3 Low pressure & Current Data

Indoor Unit : ASH070VE/ASH071VE  
ASH074VE/ASH075VE

Outdoor Unit : AXH070VE/AXH071VE  
AXH074VE/AXH075VE

### •Cooling characteristics

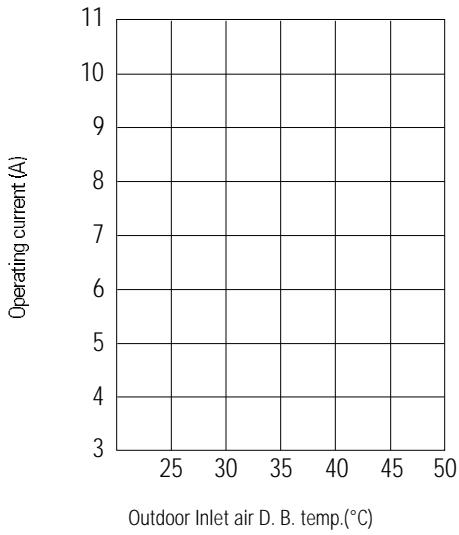

### •Heating characteristics

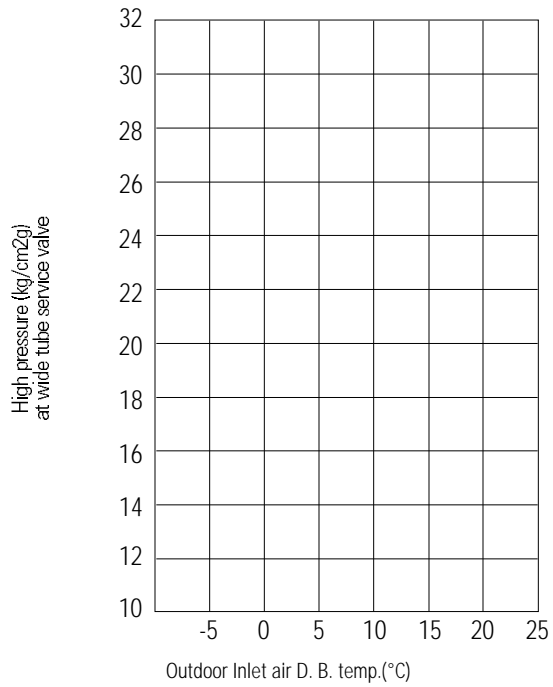
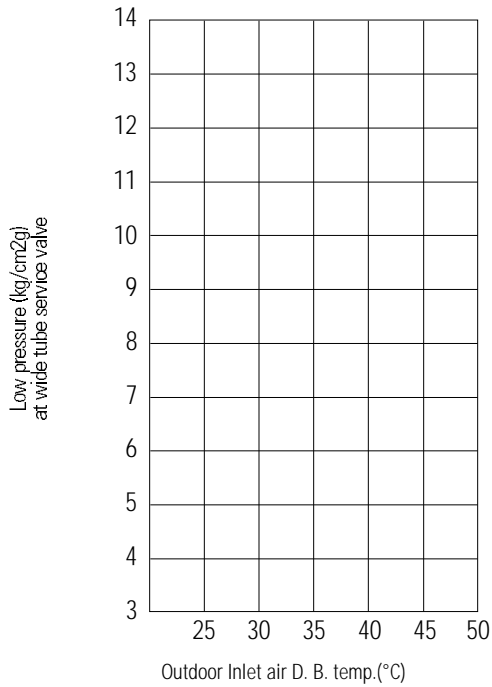
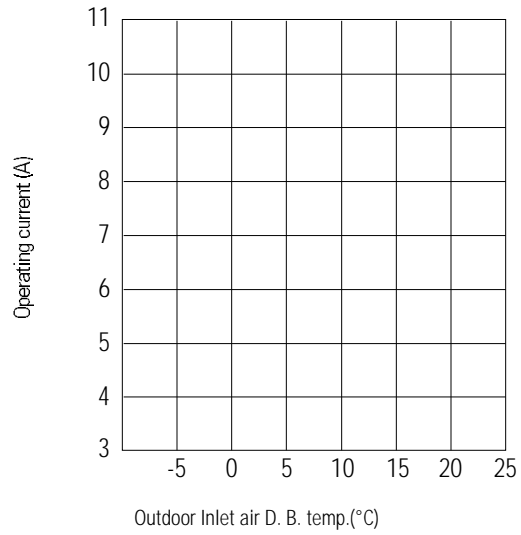

**Indoor Unit : ASH070VD/ASH071VD  
ASH074VD/ASH075VD**

**Outdoor : Unit AXH070VD/AXH071VD  
AXH074VD/AXH075VD**

**•Cooling characteristics**

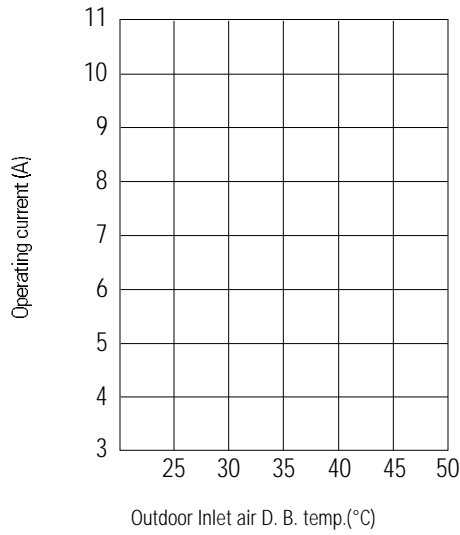

**•Heating characteristics**

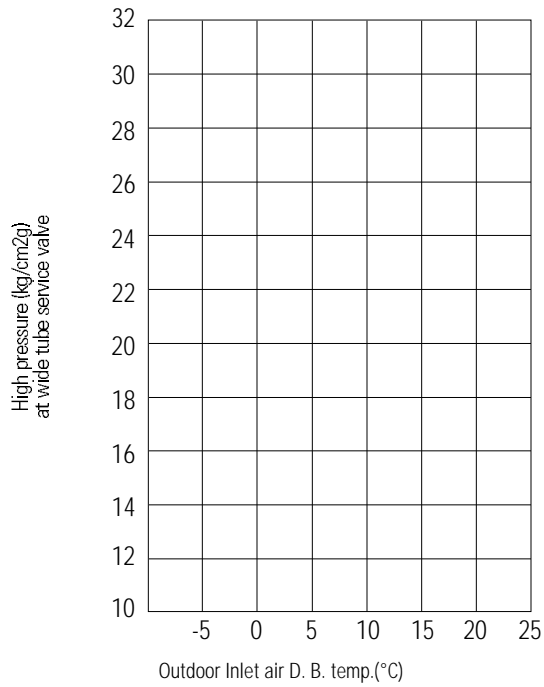
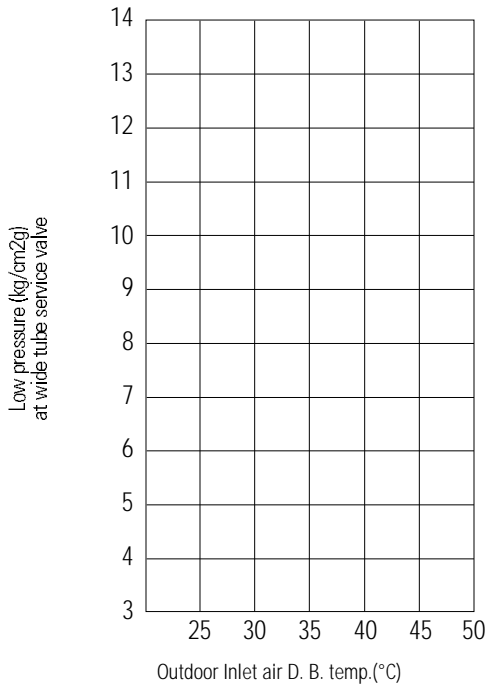
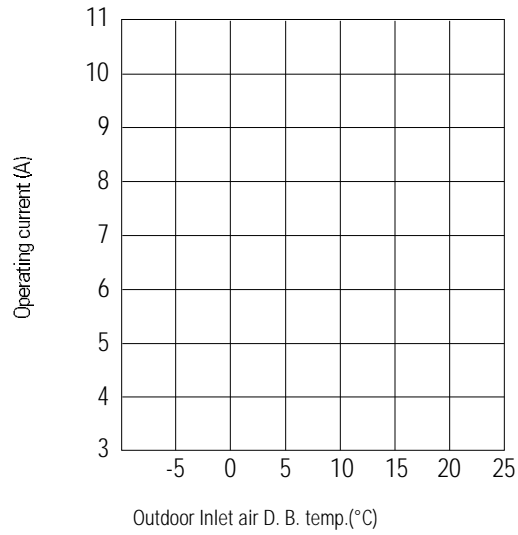



**Indoor Unit : ASH090VE/ASH091VE  
ASH094VE/ASH095VE**

**Outdoor : Unit AXH090VD/AXH091VE  
AXH094VD/AXH095VE**

**•Cooling characteristics**

**•Heating characteristics**

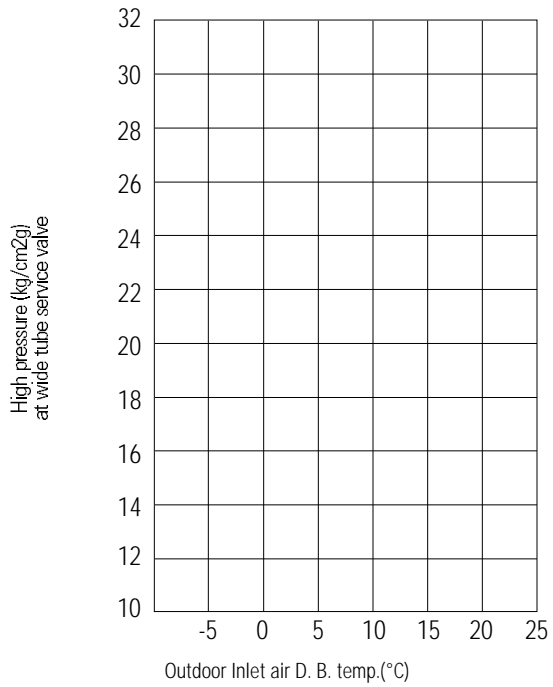
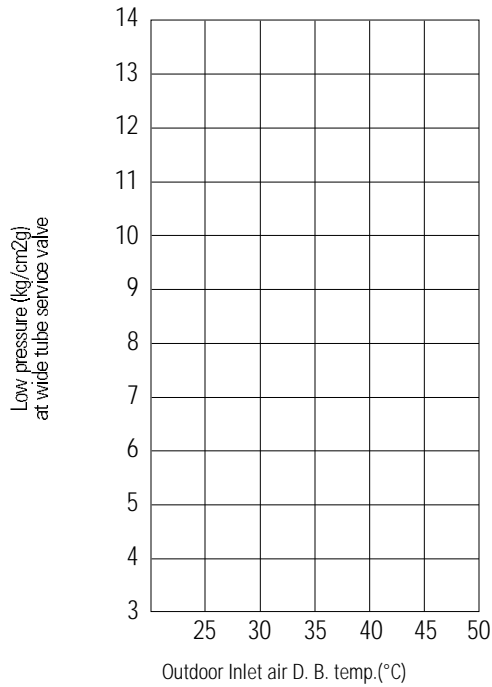
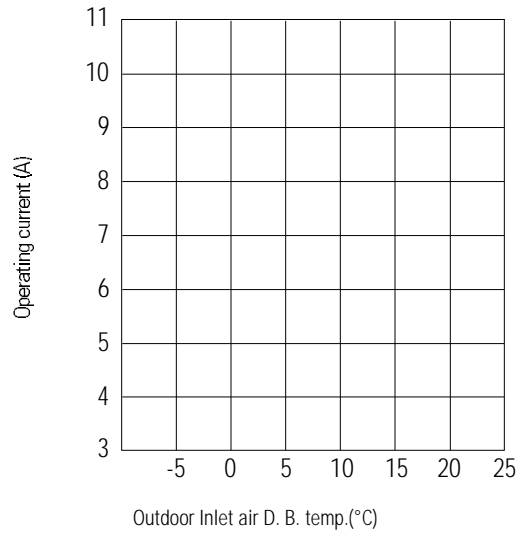
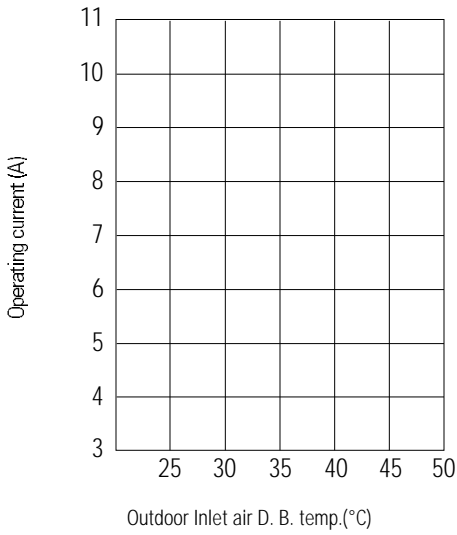

**Indoor Unit : ASH090VD/ASH091VD  
ASH094VD/ASH095VD**

**Outdoor Unit : AXH090VD/AXH091VD  
AXH094VD/AXH095VD**

**•Cooling characteristics**

**•Heating characteristics**

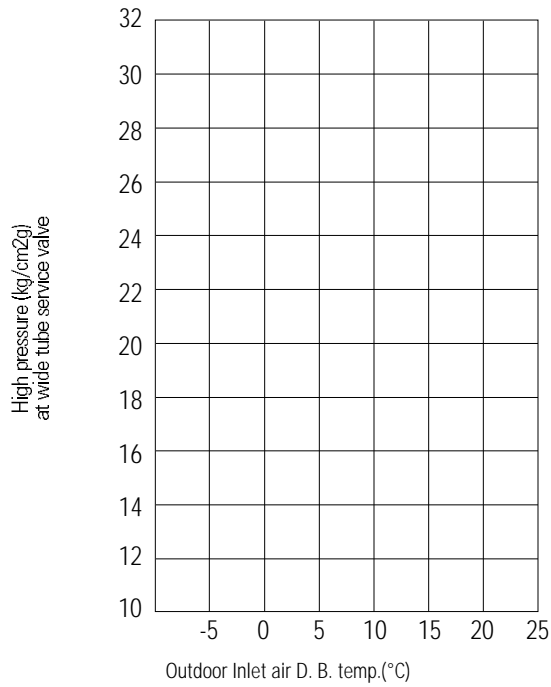
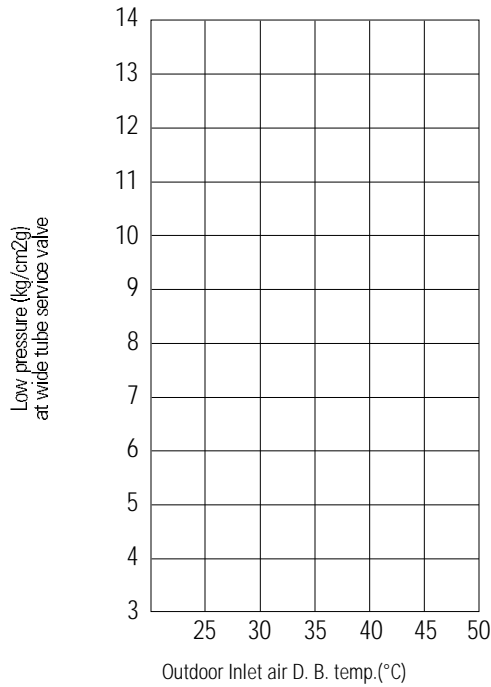
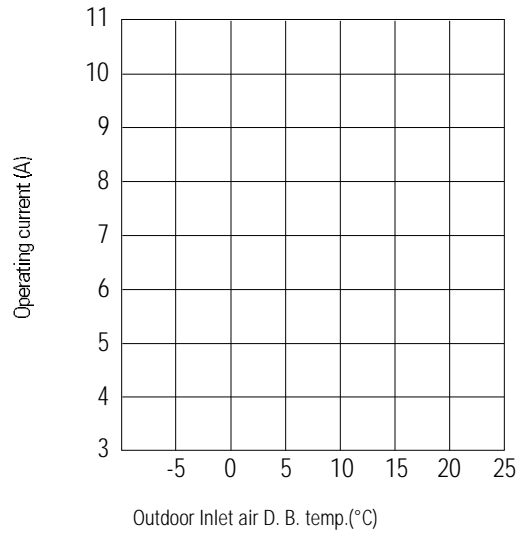
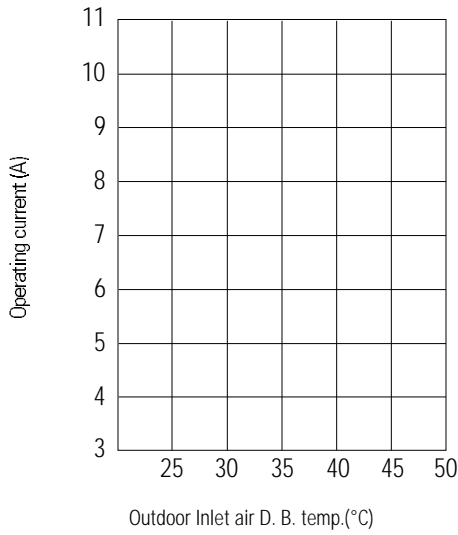

**Indoor Unit : ASH120VE/ASH121VE  
ASH124VE/ASH125VE**

**Outdoor Unit : AXH120VE/AXH121VE  
AXH124VE/AXH125VE**

**•Cooling characteristics**

**•Heating characteristics**

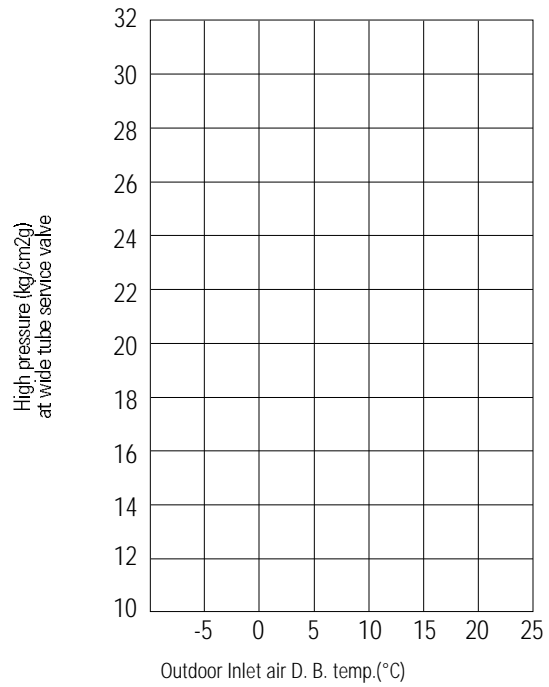
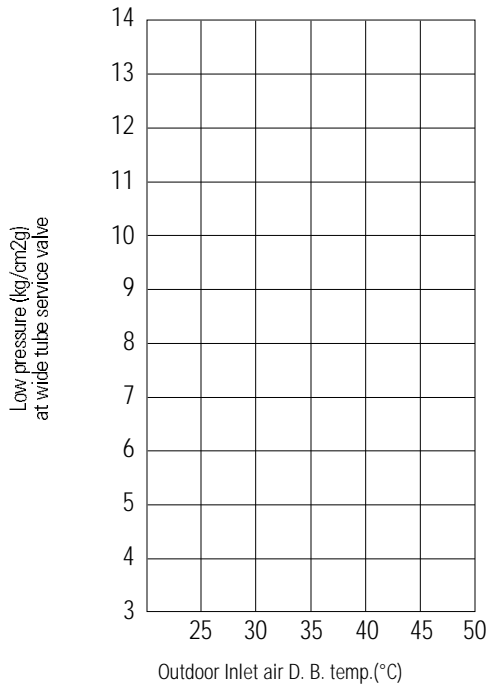
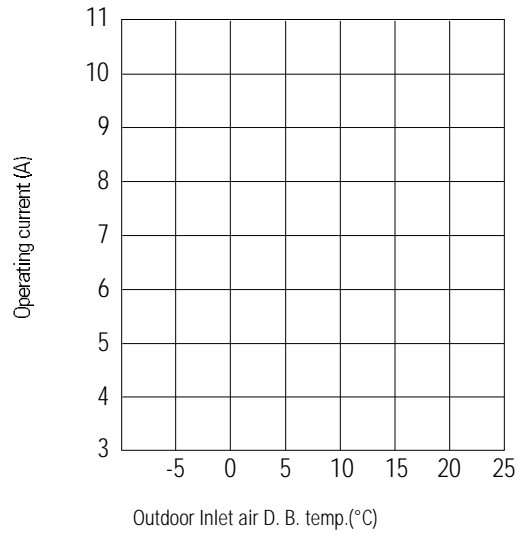
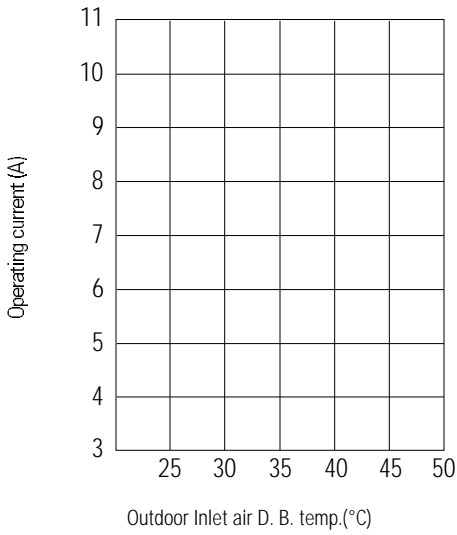

**Indoor Unit : ASH120VD/ASH121VD  
ASH124VD/ASH125VD**

**Outdoor Unit : AXH120VD/AXH121VD  
AXH124VD/AXH125VD**

**•Cooling characteristics**

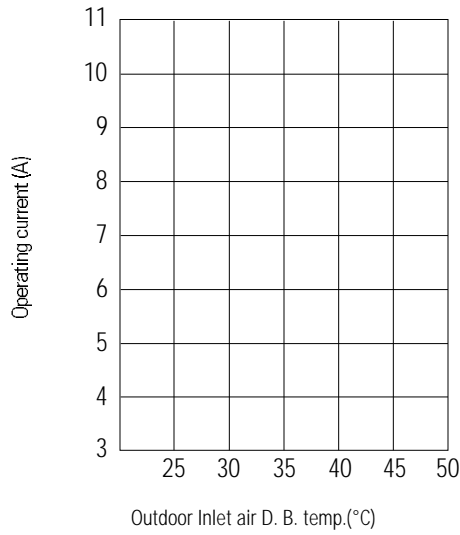

**•Heating characteristics**

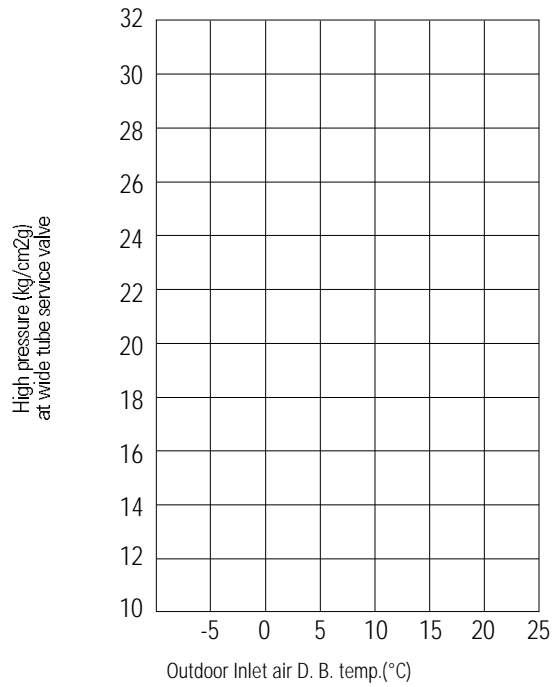
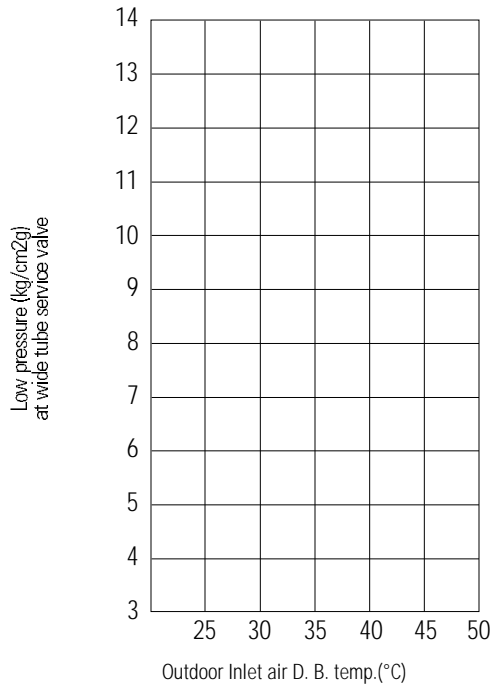
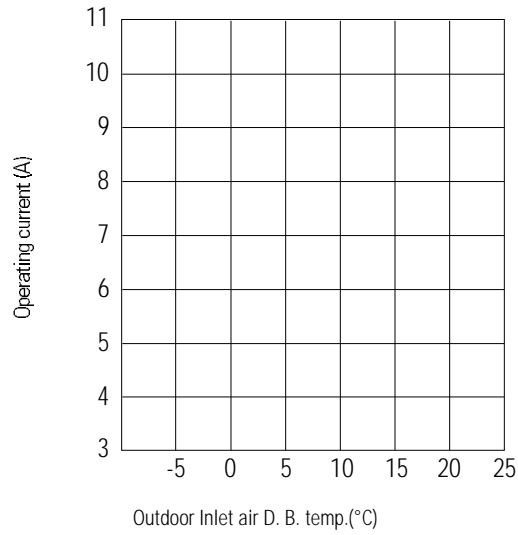



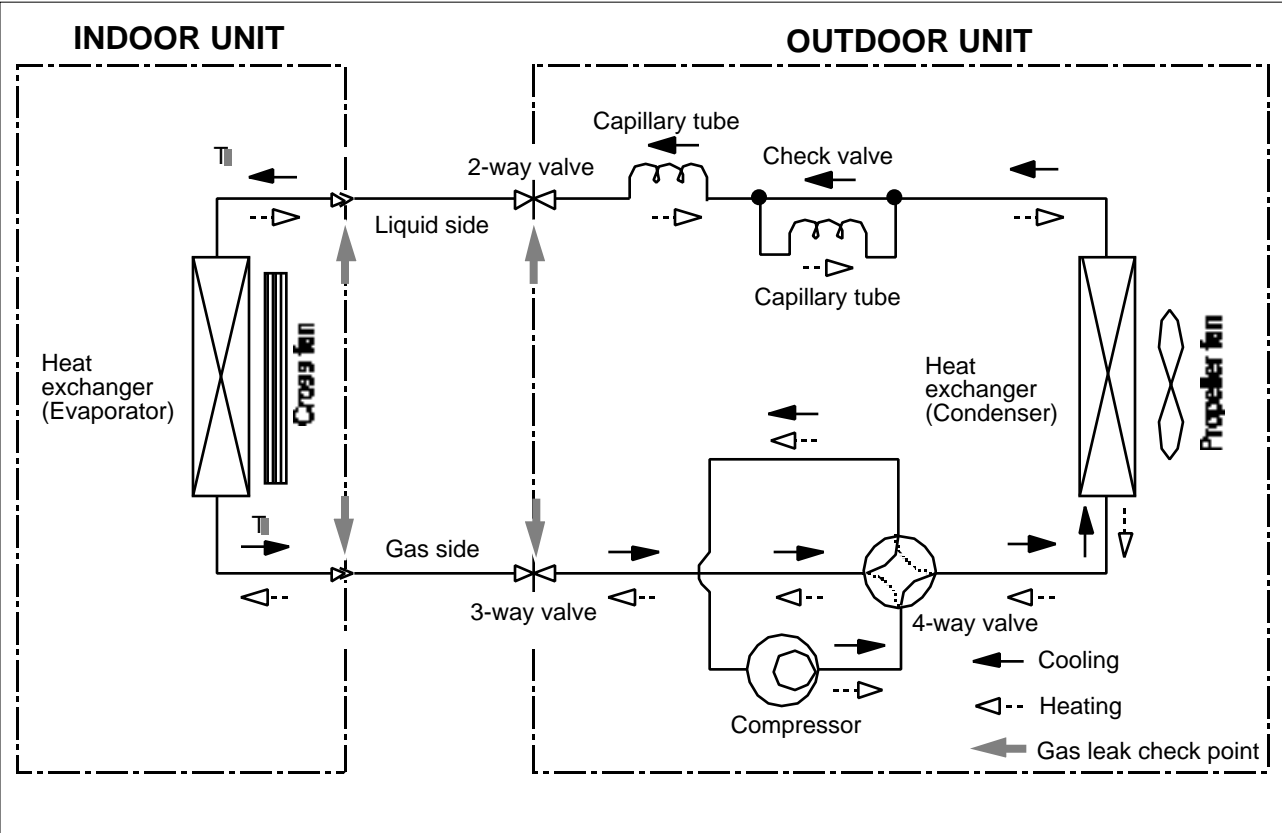







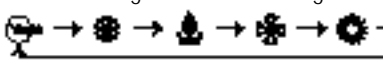

## 2-4 Refrigerating Cycle Block Diagram



## 3. Operating Instructions and Installation

### 3-1 Operating Instructions

#### 3-1-1 Name & Function of Key in remote controller

NO		NAMED OF KEY	FUNCTION OF KEY	
1			On/Off Button. Use this button to start and stop air conditioner.	
2			▲ (UP) Temp. up button. If the ▲ button is pressed once, the setting temperature is increased by 1°C	
			▼ (DOWN) Temp. up button. If the ▼ button is pressed once, the setting temperature is decreased by 1°C	
3		MODE	Each time you press this button, MODE is changed in the following order. 	
4		TURBO	Use this button to provide heavy duty cooling & Heating for 30 minutes.	
5	OFF 	Set up the reserve or cancel the timer on and timer off quickly		
6	COVER		Use this button for sleep operation. (The SLEEP mode can be selected at COOL and HEAT mode.)	
7			Adjusts air flow vertically. Each time you press this button, BLADE-H rotates by 10.58° (Changable range 42.3°)	
8			Each time you press this button, FAN SPEED is changed in the following order. 	
9		TIMER	ON TIMER	Set up the time that operation start.
10			OFF TIMER	Set up the time that operation stop.
11	SET		Use this button to reserve the timer on.	
12	CANCEL		Use this button to reserve or cancel the timer on and timer off.	
13	 (UP)		If the  button is pressed once, the time increase by one minute during the time set mode, and ten minutes during the timer set mode.	
14	 (DOWN)	If the  button is pressed once, the time decrease by one minute during the time set mode, and ten minutes during the timer set mode.		
15		TIME	Without regard to ON/OFF condition in remote controller, use this button to set current time. Adjust the current time using  button. (Data can be transmitted after setting up the time)	

### 3-1-1 Name & Function of Key in remote controller

1. **AUTO MODE** : In this mode, operation mode(COOL, HEAT, DRY) is selected automatically by the room temperature of initial operation.

Room Temp	Operation Type
Tr 21°C+ T	Cool Operation (Set Temp:AUTO SETTING)
21°C+ T>Tr	Heat Operation (Set Temp : 22°C+ T)

T= -1°, -2°C, 0°C+1°C+2°C  
 T is controlled by setting temperature up/down key of remote controller

2. **COOL MODE** : The unit operates according to the difference between the setting and room temperature. (18°C~30°C)
3. **HEAT MODE** : The unit operates according to the difference between the setting and room temperature.(16°C~30°C)  
 \*Prevention against cold wind : For about 3~5 minutes after initial operation, thermo control or “de-ice”, the indoor fan will either not operate or operate very slowly(510 rpm), then switch to the selected fan speed. This period is to allow the indoor unit's heat-exchanger to prewarm before emitting warm air.  
 \*High temperature release function : The outdoor unit for and compressor ON/OFF control for safety operation, when the overheat is heat exchanger of indoor unit.  
 \*De-ice : Deicing operation is controlled by indoor unit's heat exchanger temperature and accumulating time of compressor's operation.  
 De-ice end by sensing of the processing time by de-ice Condition.

4. **DRY MODE** : Has 3 states, each determined by room temperature.  
 The unit operates in DRY mode.  
 \*Compressor ON/OFF Time is controlled compulsorily(can not set up the fan speed, always breeze).  
 \*Protective function : Low temperature release. (Prevention against freeze)
5. **TURBO MODE** : This mode is available in AUTO, COOL, HEAT, DRY, FAN MODE.  
 When this button is pressed at first, the air conditioner is operated “powerful” state for 30 minutes regardless of the set temperature, room temperature.  
 When this button is pressed again, or when the operating time is 30 minutes, turbo operation mode is canceled and returned to the previous mode.  
 \*But, if you press the TURBO button in DRY or FAN mode that is changed with AUTO mode automatically.
6. **SLEEP MODE** : Sleep mode is available only in COOL or HEAT mode.  
 The operation will stop after 6 hours.  
 \*In COOL mode : The setting temperature is automatically raised by 1°C each 1hour  
 When the temperature has been raised by total of 2°C, that temperature is maintained.  
 \*In HEAT mode : The setting temperature is automatically dropped by 1°C each 1hour.  
 When the temperature has been dropped by total of 2°C, that temperature is maintained.
7. **FAN SPEED** : Manual (3 step), Auto (4 step)  
 Fan speed automatically varies depending on both the difference between setting and the room temperature.

**8. COMPULSORY OPERATION :**



For operating the air conditioner without the remote controller.

\*AUTO : The operating is the same function that AUTO MODE in the remote controller.

**9. SWING : BLADE-H is rotated vertically by the stepping motor.**

\*Memory louver : When ON/OFF button is pressed at stop state, the BLADE-H returns to its original location which is operating state before stop

\*Swing auto : The BLADE-H can rotate within about 10,500 in the original position set by the SWING SET button.

\*Swing Set : Press the  button under the remote control is displayed on LCD the  and the blades move up and down, about 10. If the one more time press the  button, blades location is stop.

**10. Quick OFF TIMER: OFF timer (quick timer) allows reservation or cancel the timer on and timer off quickly**

When OFF timer button is pressed at operating state, LCD displays the polling state sequentially.

The LCD also displays the time remaining.

**11. 24-Hour ON/OFF Real Setting Timer. : The air conditioner is turned ON at a specified time using ON TIMER.**

OFF TIMER : The air Conditioner is turned

OFF at a specified time using OFF TIMER.

\*ON TIMER : Only timer LED lights on.

\*OFF TIMER : Both timer and operation LED lights on.

\*3 minutes delay timer.

**14. SELF Diagnosis**

LED DISPLAY				Check Point
operation	TIMER	FAN	Turbo	
■	○	○	○	Interruption of electric power and Power on.
○	■	○	○	Abnormal condition of the room sensor.
■	■	○	○	Abnormal condition of the indoor unit's heat exchanger sensor.
○	○	■	○	Indoor unit fan motor lock.

■ : LED blinking      ○ : LED off

**15. TIME SHORTENING : If the "Time short" connector pin is shorted on the main P. C. B, the compressor's three minutes delay function is cancelled, and each operation time is shortened to one fiftieth of its original time.**

**16. BUZZER SOUND : Whenever the ON/OFF button is pressed or whenever change occurs to the condition which is set up or select, the compulsory operation mode, buzzer is sounded "beep"**



## 3-2 Installation

---

### 3-2-1 Selecting Area for Installation

Select an area for installation that is suitable to the customer's needs.

#### 3-2-1(a) Indoor Unit

1. Make sure that you install the indoor unit in an area providing good ventilation. It must not be blocked by an obstacle affecting the airflow near the air inlet and the air outlet.
2. Make sure that you install the indoor unit in an area allowing good air handling and endurance of vibration of the indoor unit.
3. Make sure that you install the indoor unit in an area where there is no source of heat or vapor nearby.
4. Make sure that you install the indoor unit in an area from which hot or cool air is spread evenly in a room.
5. Make sure that you install the indoor unit in an area away from TVs, audio units, cordless phones, fluorescent lighting fixtures and other electrical appliances (at least 1 meter).
6. Make sure that you install the indoor unit in an area which provides easy pipe connection with the outdoor unit, and easy drainage for condensed water.
7. Make sure that you install the indoor unit in an area which is large enough to accommodate the measurements shown in figure on the next page.

#### 3-2-1(b) Outdoor Unit

1. Make sure that you install the outdoor unit in area not exposed to the rain or direct sun light.  
(Install a separate sunblind if exposed to direct sun light.)
2. Make sure that you install the outdoor unit in area allowing good air moment, not amplifying noise or vibration, especially to avoid disturbing neighbours.

(Fix the unit firmly if it is mounted in a high place.)

3. Make sure that you install the outdoor unit in area providing good ventilation and which is not dusty. It must not be blocked by any obstacle affecting the airflow near the air inlet and the air outlet.
4. Make sure that you install the outdoor unit in area free from animals or plants.
5. Make sure that you install the outdoor unit in area not blocking the traffic.
6. Make sure that you install the outdoor unit in area easy to drain condensed water from the indoor unit.
7. Make sure that you install the outdoor unit in area which provides easy connection within the maximum allowable length of a coolant pipe(15 meters).

#### Note

1. Add 10 grams of refrigerant (R-22) for every 1 meter if the pipe length exceeds the standard pipe length of 5 meters.
2. Maintain a height between the indoor and outdoor units of less than 3 meters.
8. Make sure that you install the outdoor unit in an area which is large enough to accommodate the measurements shown in figure on the next page.

#### 3-2-1(c) Remote Control Unit

1. Make sure that you install the remote control unit in an area free from obstacles such as curtains etc, which may block signals from the remote control unit.
2. Make sure that you install the remote control unit in an area not exposed to direct sunlight, and where there is no source of heat.
3. Make sure that you install the remote control unit in an area away from TVs, audio units, cordless phones, fluorescent lighting fixtures and other electrical appliances (at least 1 meter).

#### Caution :

It is harmful to the air conditioner if it is used in the following environments: greasy areas (including areas near machines), salty areas such as coast areas, areas where sulfuric gas is present such as hot spring areas. Contact your dealer for advice.

### 3-2-2 Installation diagram of indoor unit and outdoor unit

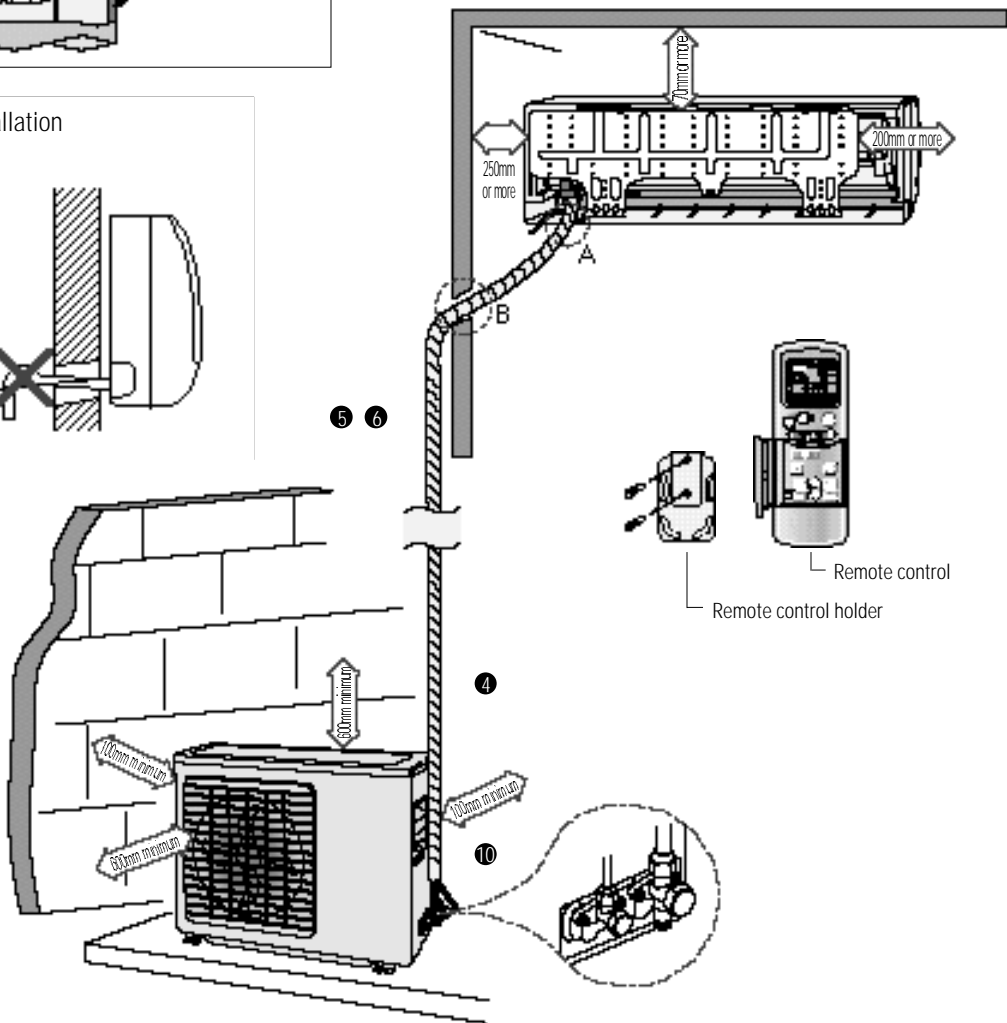
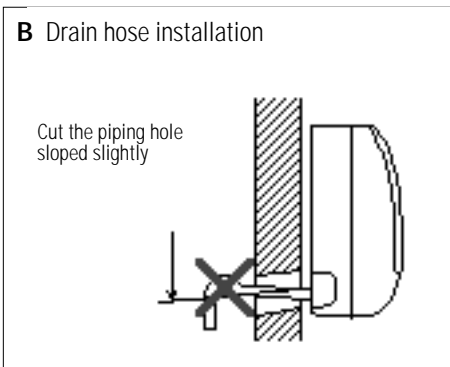
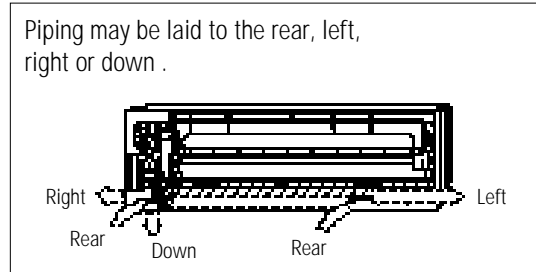
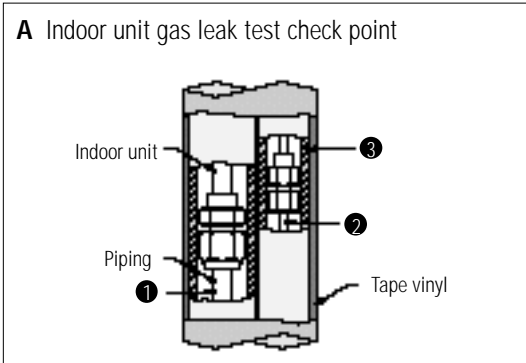

①	Piping (Liquid) 1/4"	⑥	Clamper tube
②	7K/9K BTU Piping(Gas)3/8" 12K BTU Piping(Gas)1/2"	⑦	Installation plate
③	Installation tube	⑧	Pipe-connection
④	Vinyl tape	⑨	Screw
⑤	Putty	⑩	Drain hose

### 3-2-2(a) Fixing the Installation Plate

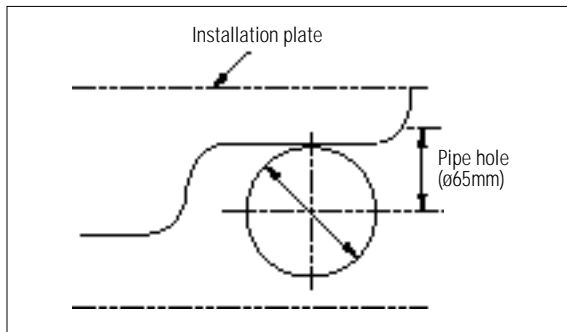

1. Determine the position of the pipe and drain hose hole using the right figure and drill the hole with an inner diameter of 65mm so that it slants slightly downwards.

2. If you are fixing the indoor unit to a... Then follow Steps...

Wall

3.

Window frame

4 to 6.

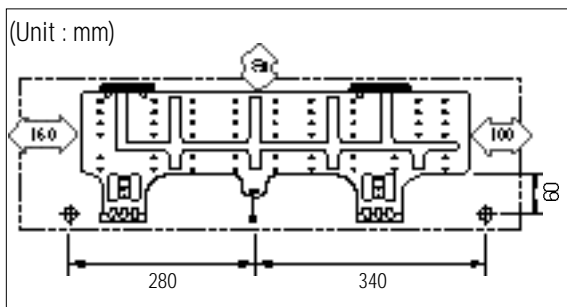

3. Fix the installation plate to the wall in a manner appropriate to the weight of the indoor unit.

If you are mounting the plate on a concrete wall with anchor bolts, the anchor bolts must not project by more than 20mm.

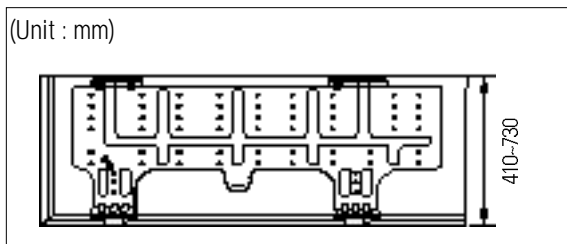

4. Determine the positions of the wooden uprights to be attached to the window frame.

5. Attach the wooden uprights to the window frame in a manner appropriate to the weight of the indoor unit.

6. Using tapped screws, attach the installation plate to the wooden uprights, as illustrated in the last figure opposite.

### 3-2-2(b) Purging the Unit

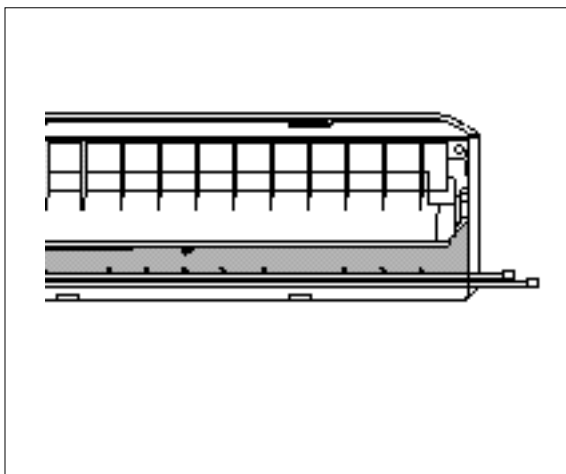

***On delivery, the indoor unit is loaded with an inert gas. All this gas must therefore be purged before connecting the assembly piping. To purge the inert gas, proceed as follows.***

Unscrew the caps at the end of each pipe.

**Result :** All inert gas escapes from the indoor unit.

- **To prevent dirt or foreign objects from getting into the pipes during installation, do NOT remove the caps completely until you are ready to connect the piping.**

3-2-2(c) Connecting the Assembly Cable.

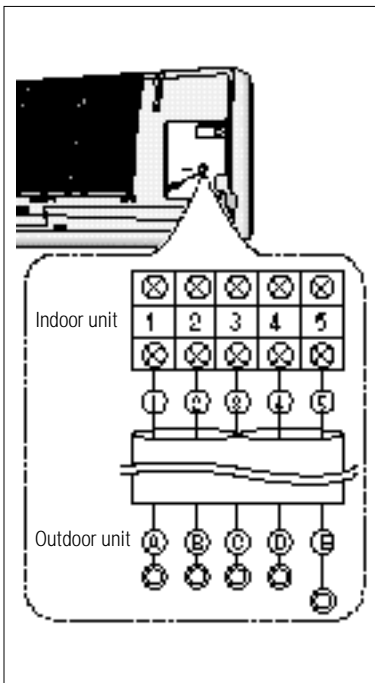

**The outdoor unit is powered from the indoor unit via the assembly cable. If the outdoor unit is more than five metres away from the indoor unit, the cable must first be extended to a maximum of ten metres.**

1. Extend the assembly cable if necessary.
2. Open the front grille by pulling on the tabs on the lower right and left sides of the indoor unit.
3. Remove the screw securing the connector cover.
4. Pass the assembly cable through the rear of the indoor unit and connect the assembly cable to terminals 1 to 5.
  - Each wire is labelled with the corresponding terminal number.
5. Firmly fix the ass'y cable with clamp wire holder.
6. Pass the other end of the cable through the 65mm hole in the wall.
7. Replace the connector cover, carefully tightening the screw.
8. Close the front grille.
9. For further details on how to plug the other end of the assembly cable into the outdoor unit, refer to page 12.

3-2-2(d) Installing and Connecting the Indoor Unit Drain Hose

**Care must be taken when installing the drain hose for the indoor unit to ensure that any condensation water is correctly drained outside. When passing the drain hose through the 65mm hole drilled in the wall, check that none of the following situations occur.**

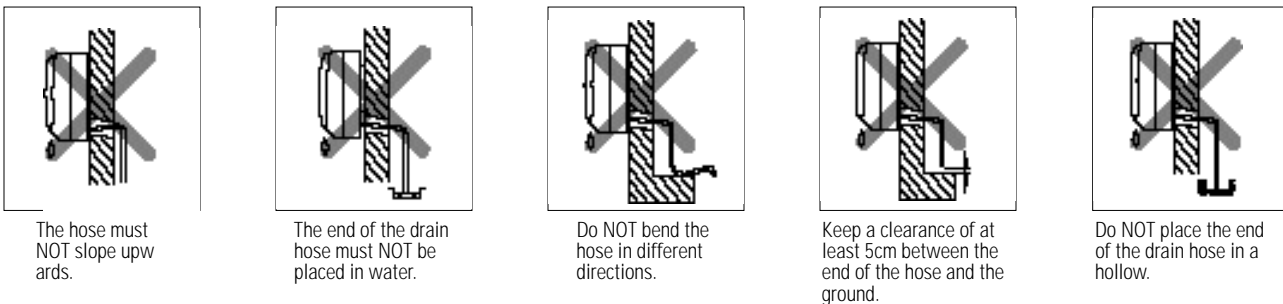

**To install the drain hose, proceed as follows.**

1. If necessary, connect the 2-metre extension to the drain hose.
2. If you are using the extension, insulate the inside part of the extension drain hose with a shield.
3. Pass the drain hose under the refrigerant piping, taking care to keep the drain hose tight.
4. Pass the drain hose through the hole in the wall, making sure that it is sloping downwards, as shown in the illustrations above.

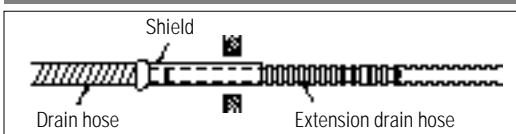

**The hose will be fixed permanently into position once the whole installation has been tested for gas leaks; refer to page 16 for further details.**

### 3-2-2(e) Outdoor unit installation

#### Wiring connection

1. Remove the cover-E parts.
2. Firmly connect the cable connector in the terminal block.
3. Fasten the M4 ring terminal to the hole marked
4. Firmly fix the ass'y cable with clamp wire holder.
5. Assemble the cover-E parts.
6. To prevent the entry of water, form a trap of the ass'y cable as illustrated in the installation diagram of indoor and outdoor unit.

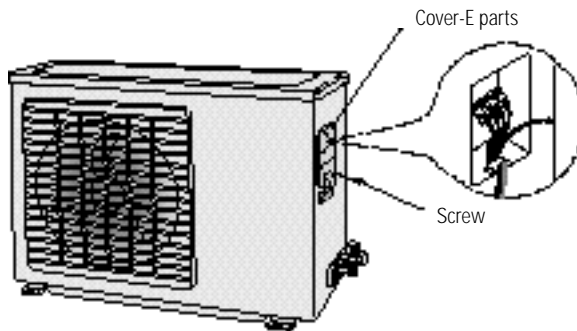

#### Installation of drain line

In heating and de-ice operation, condensed water may be generated. Install drain line as following procedure.

1. Close Hole ③ with Cap Drain A.
2. Close Hole ② with Cap Drain B.
3. Insert Drain plug into Hole ①, and then connect drain hose to drain plug.
  - Inside diameter of drain hose is 18mm.

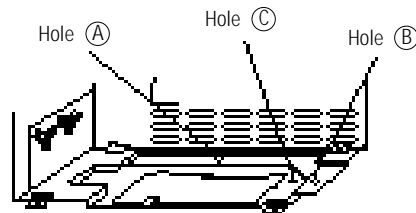

Drain Plug



Cap-Drain A



Cap-Drain B

3-2-2(f) Flare Modification

• Tools used

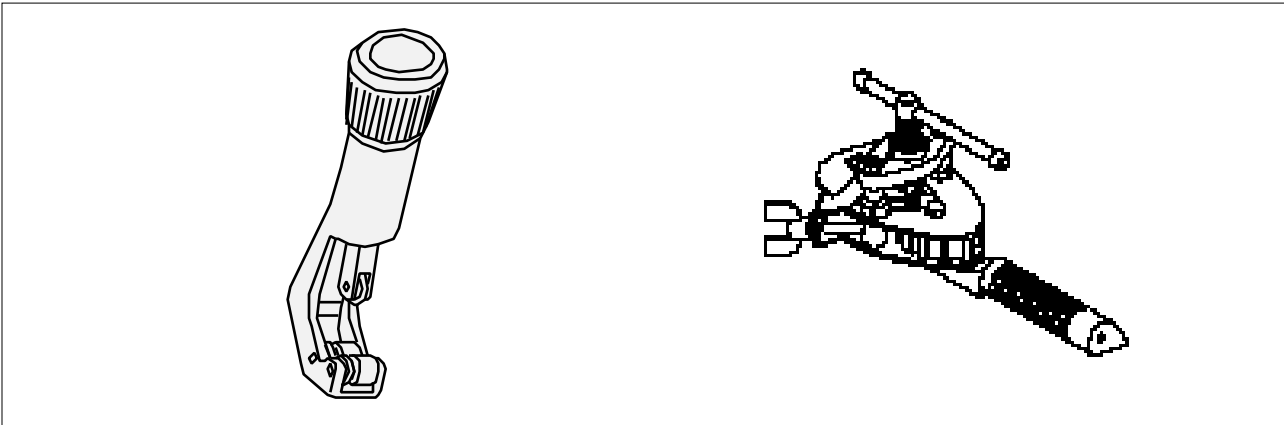

Flare modification procedure

1) Cut the pipe using a pipe cutter.

2) Remove burrs at the tip of the pipe cut.

Caution : Burrs not removed may result in leakage of gas.

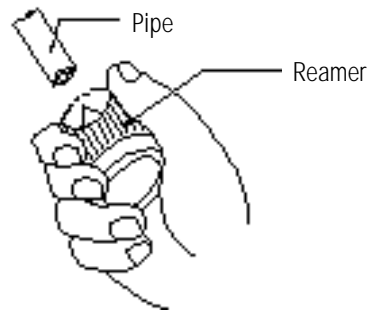
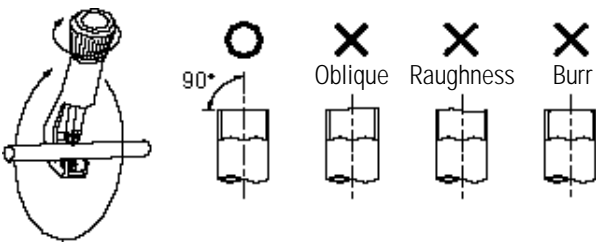

3) Insert a flare nut into the pipe and modify flare.

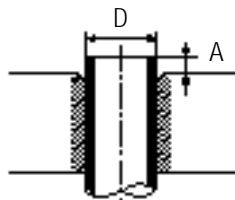

Outer diameter	A(mm)
ø6.35mm	1.3
ø9.52mm	1.8
ø12.7mm	2.0

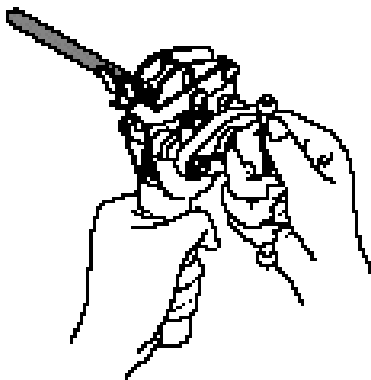

\* Unproper flaring

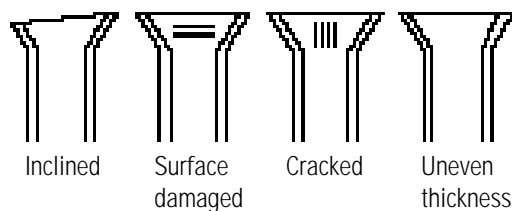

### 3-2-2(g) Air-Purge Procedure

- Use the refrigerant of the outdoor unit to purge air inside indoor unit and pipe.

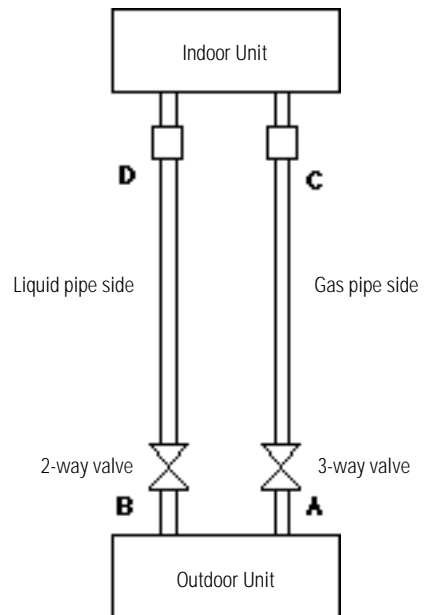
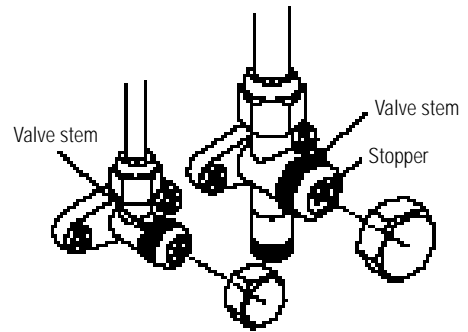
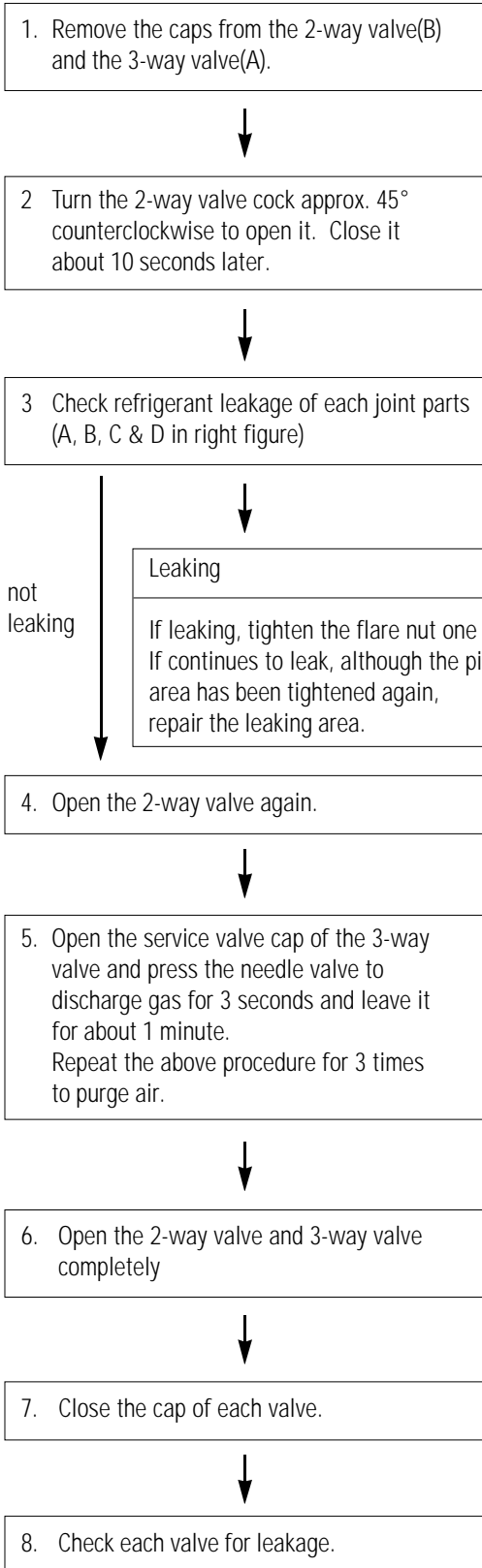

### 3-2-2(h) Refrigerant Refill

- Refill an air-conditioner with refrigerant when refrigerant has been leaked at installing or using

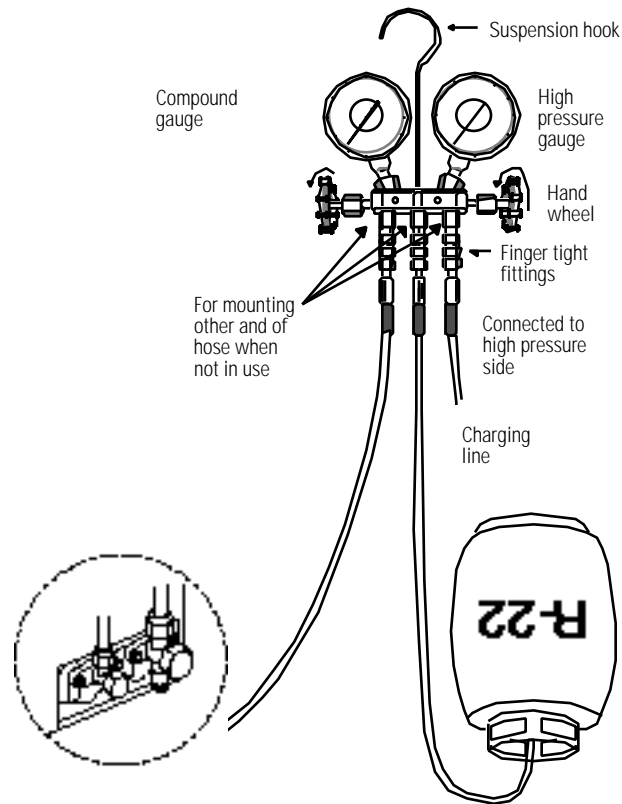
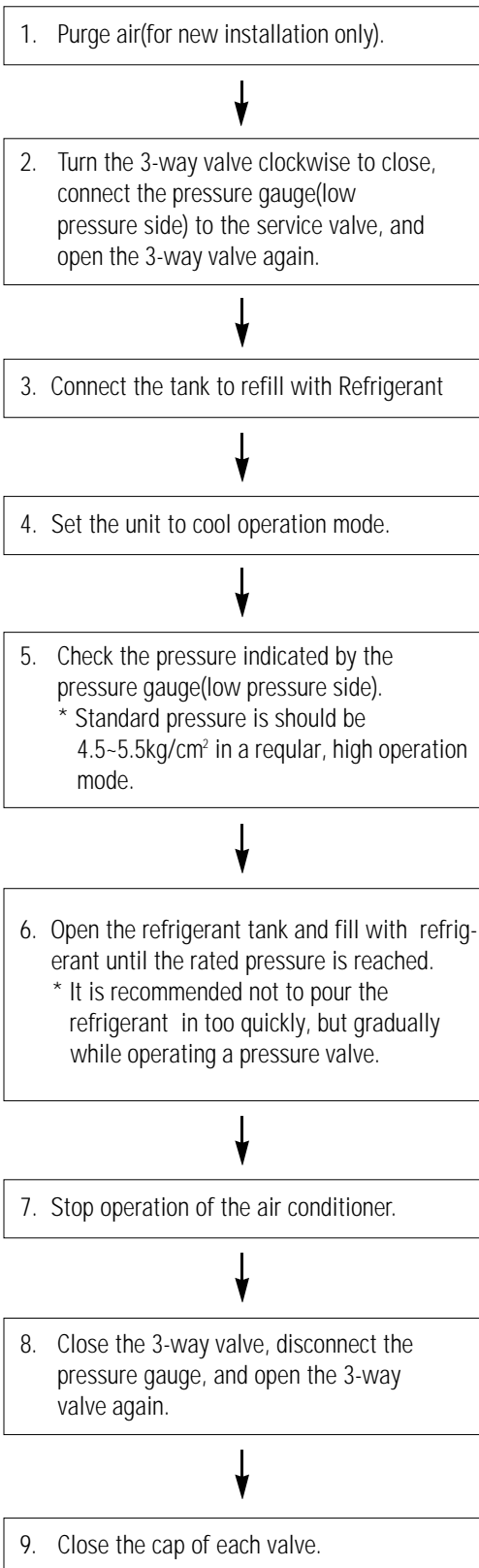



### 3-2-2(i) Refrigerant Adjustment

Class Connection Pipe Length	At installation		At service	
	Air-Purge Method	Refrigerant Adjustment	Air-Purge Method	Refrigerant Quantity
5m Max.	Refer to the detailed Air-Purge Procedure	Unnecessary	Purge air using a vaccum pump or an additional refrigerant cylinder.	refer to specification sheet
5-10m		Add 10g of refrigerant (R-22) for every 1m.		Add 10g of refrigerant (R-22) for every 1m.

### 3-2-2(j) Flare unt fixing torque

Outter diameter	Torque (kg-cm)	
	Fixing Torque	Final Torque
ø 6.35 (9000Btu, 12000Btu) (Liquid Side)	160	200
ø 9.52 (9000Btu) (Gas Side)	300	350
ø 12.7 (12000Btu) (Gas Side)	500	550

3-2-2(k) "Pump down" Procedure

- **'Pump down'** shall be carried out when an evaporator is replaced or when the unit is relocated in another area.

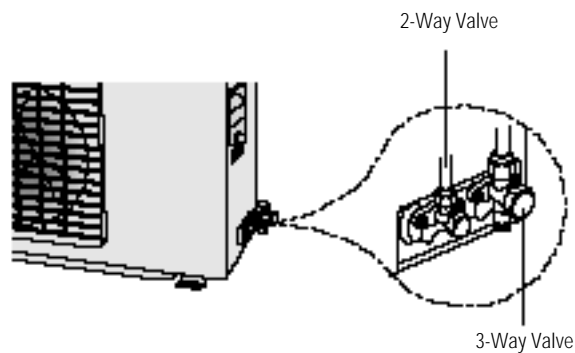
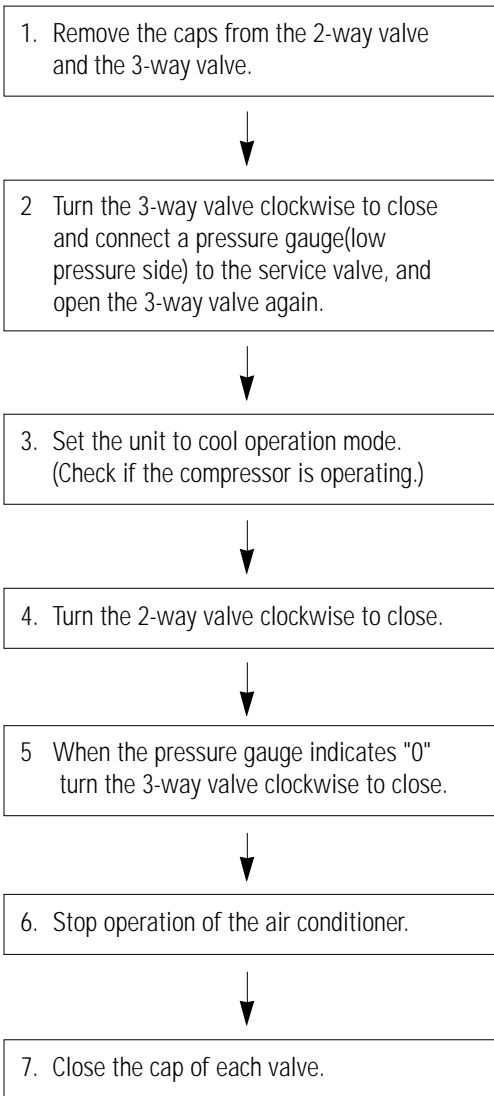

**Relocation of the air conditioner**

- Refer to this procedure when the unit is relocated.





<ol style="list-style-type: none"> <li>1. Carry out the pump down procedure (refer to the details of 'pump down').</li> <li>2. Remove the power cord.</li> <li>3. Disconnect the assembly cable from the indoor and outdoor units.</li> <li>4. Remove the flare nut connecting the indoor unit and the pipe. At this time, cover the pipe of the indoor unit and the other pipe using a cap or vinyl plug to avoid foreign material entering.</li> </ol>	<ol style="list-style-type: none"> <li>5. Disconnect the pipe connected to the outdoor unit. At this time, cover the valve of the outdoor unit and the other pipe using a cap or vinyl plug to avoid foreign material entering.</li> <li>6. Make sure you do not bend the connection pipes in the middle and store together with the cables.</li> <li>7. Move the indoor and outdoor units to a new location.</li> <li>8. Remove the mounting plate for the indoor unit and move it to a new location.</li> </ol>
--	---

# MEMO

## 4. Disassembly and Reassembly

Stop operation of the air conditioner and remove the power cord before repairing the unit.



### 4-1 Indoor Unit

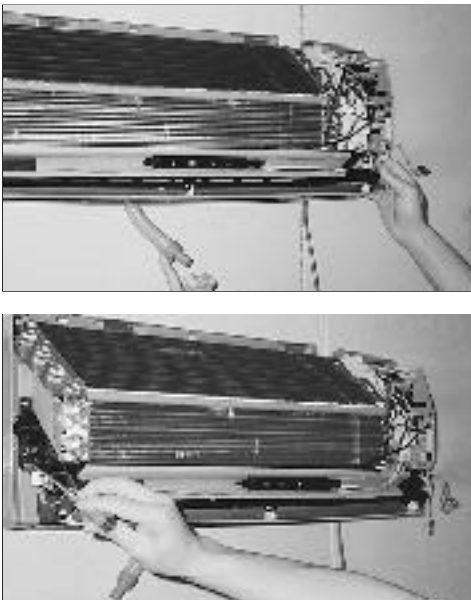
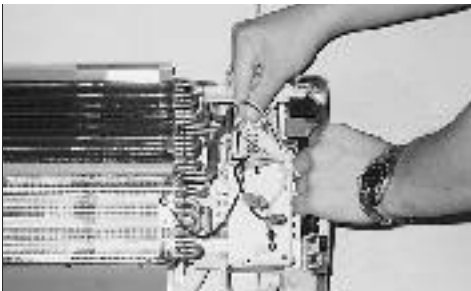
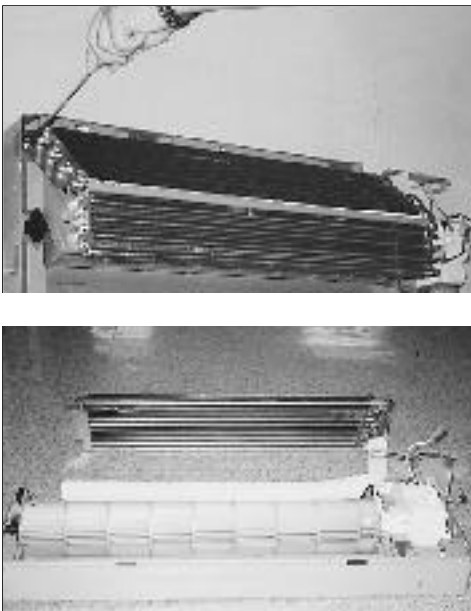

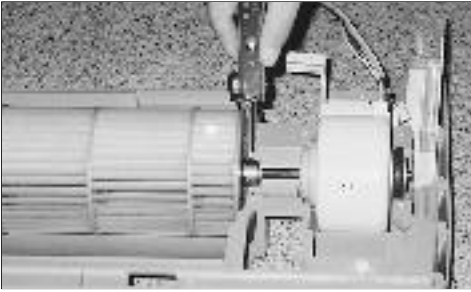
No	Parts	Procedure	Remark
1	Front Grille	<p>1) Stop the air conditioner operation and block the main power.</p> <p>2) Separate tape of front panel upper.</p> <p>3) Contract the second finger to the left, and right handle and pull to open the inlet grille.</p> <p>4) Take the left and right filter out.</p> <div style="border: 1px solid black; padding: 5px; margin: 5px 0;"> <p>* Take the Deodorizing and Electrostatic filter out. (ONLY "1" and "5" Series models)</p> </div> <p>5) Loosen one of the right fixing screw and separate the terminal cover.</p> <p>6) Loosen two fixing screws of front grille.</p> <p>7) Pull the upper left and right of discharge softly for the outside cover to be pulled out.</p> <p>8) Pull softly the lower part of discharge and push it up.</p> <p><b>Caution;</b> Assemble the front panel and fix the hooks of left and right.</p>	    

No	Parts	Procedure	Remark
2	Ass'y Tray Drain.	<ol style="list-style-type: none"> <li>1) Do "1", above. Separate the drain hose from the extension drain hose.</li> <li>2) Take the display PCB out. (Center of indoor unit)</li> <li>3) Loosen three fixing screws of left and right</li> <li>4) Pull tray drain out from the back body.</li> </ol>	
3	Electrical Parts (Main PCB)	<ol style="list-style-type: none"> <li>1) Do "1", "2", above</li> <li>2) Take all the connector of PCB upper side out. (Inclusion Power cord)</li> <li>3) Separate the outdoor unit connection wire from the terminal block.</li> <li>4) If pulling the Main PCB up. it will be taken out. (Separate the TRANS hook. it before).</li> </ol>	
4	Heat Exchanger	<ol style="list-style-type: none"> <li>1) Do "1" and "2", "3", above</li> <li>2) Loosen two fixing earth screws of right side.</li> <li>3) Separate the connection pipe.</li> <li>4) Separate the bush body at the upper side and holder at the rear side.</li> <li>5) Loosen the two fixing screws of left side.</li> <li>6) Lifting the heat exchanger up a little to push the up side for separation from the indoor unit.</li> </ol>	

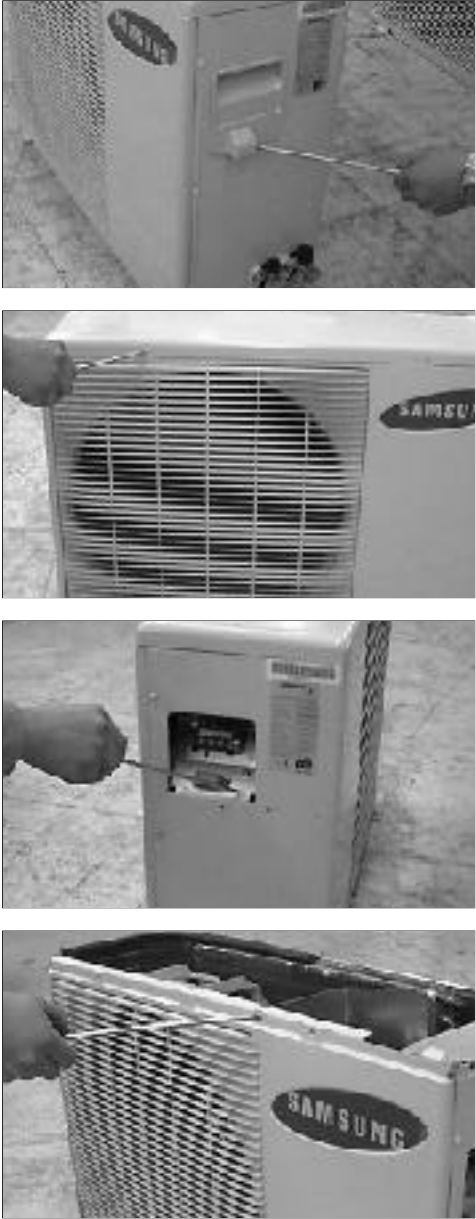
No	Parts	Procedure	Remark
3	Fan Motor and Cross Fan	<ol style="list-style-type: none"><li>1) Do "1" "2" "3" "4", above.</li><li>2) Loosen the fixing three screws and separate the motor holder.</li><li>3) Loosen the fixing screw of fan motor. (By use of M3 wrench)</li><li>4) Separate the fan motor from the fan.</li><li>5) Separate the fan from the left holder bearing.</li></ol>	 

### 4-2-2 HORIZONTAL TYPE

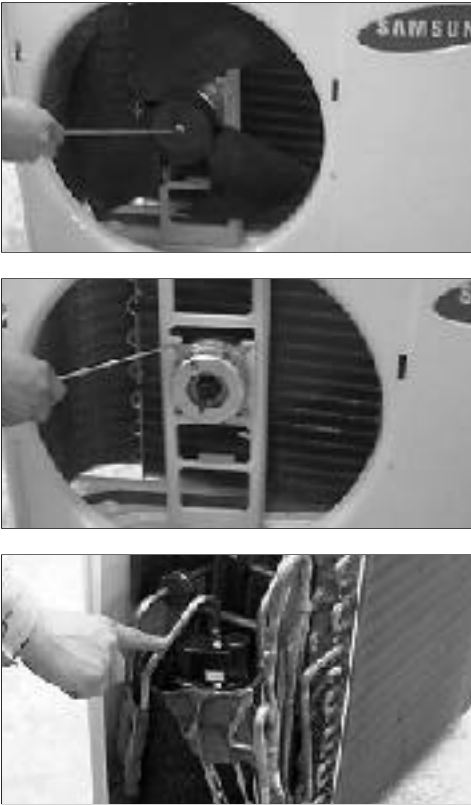
No	Parts	Procedure	Remark
1	Common Work	<ol style="list-style-type: none"> <li>1) Loosen the fixing screw and separate the cover E-parts.</li> <li>2) Separate the connection wire from the terminal block.</li>   <li>3) Loosen three fixing screws and separate the upper cabinet.</li>   <li>4) Loosen the two fixing screws of Ass'y E-part.</li>   <li>5) Loosen seven fixing screws and separate the side cabinet.</li> </ol>	
2	Fan and Motor	<ol style="list-style-type: none"> <li>1) Do "1", above.</li> <li>2) Loosen two fixing screw, of the front cabinet.</li> <li>3) Push the brackets of the outer cover to separate the protection mesh from the rear side of front cabinet.</li> </ol>	



No	Parts	Procedure	Remark
		<p>4) Remove the nut flange (Turn to the right to remove, as it is a left hand screw)</p> <p>5) Separate the fan.</p> <p>6) Loosen four fixing screws to separate the motor.</p>	
3	Heat Exchanger	<p>1) Do "1", above.</p> <p>2) Loosen three fixing screws of left and right side.</p> <p>3) Disassemble the inlet and outlet pipe by welding.</p> <p>4) Separate the heat exchanger.</p>	
4	Compressor	<p>1) Do "1", above.</p> <p>2) Open the terminal cover of compressor and unscrew the connection terminal.</p> <p>3) Disassemble the inlet and outlet pipe of compressor by welding.</p> <p>4) Disassemble the inlet and outlet pipe of condenser by welding</p> <p>5) Loosen the three bolts of the lower part.</p> <p>6) separate the compressor.</p>	



## 5. Troubleshooting

### 5-1 Items to be checked first

- 1) **Is the voltage of the power correct?**  
The input voltage shall be 198-264VAC.  
The airconditioner may not operate properly if the voltage is out of this range.
- 2) **Is the link cable linking the indoor unit and the outdoor unit linked properly?**  
The indoor unit and the outdoor unit shall be linked by 5 cables.  
Check the terminals if the indoor unit and outdoor unit are properly linked by the same number of cables.  
Otherwise the airconditioner may not operate properly.
- 3) **When a problem occurs due to the contents illustrated in the table below it is a symptom not related to the malfunction of the airconditioner.**

NO	Operation of air conditioner	Explanation
1	The COOL operation indication LED (Green) blinks when a power plug of the indoor unit is plugged in for the first time.	It indicates power is on. The LED stops blinking if the operation ON/OFF button on the remote control unit is pushed.
2	In a COOL operation mode, the compressor does not operate at a room temperature higher than the setting temperature that the IN DOOR FAN should operate. In a HEAT operation mode, the compressor does not operate at a room temperature lower than the setting temperature that indoor fan should operate.	In happens after a delay of 3 minutes when the compressor is reoperated. The same phenomenon occurs when a power is on. As a phenomenon that the compressor is reoperated after a delay of 3 minutes, the indoor fan is adjusted automatically with reference to a temperature of the air blew
3	Fan speed setting is not allowed in AUTO or DRY mode.  	The speed of the indoor fan is set to LL in DRY mode. Fan speed is 5 steps is selected automatically in AUTO mode.
4	Compressor stops operation intermittently in DRY mode. 	Compressor operation is controlled automatically in DRY mode depending on the room temperature and humidity.
5	Compressor of the outdoor unit is operating although it is turned off in a HEAT mode.	When the unit is turned off while de-ice is activated, the compressor continues operation for up to 9 minutes (maximum) until the deice is completed.
6	Timer LED only of the indoor unit lights up and the air conditioner does not operate.	Timer is being activated and the unit is in ready mode. The unit operates normally if the timer operation is cancelled.
7	The compressor and indoor fan stop intermittently in HEAT mode.	The compressor and indoor fan stop intermittently if room temperature exceeds a setting temperature in order to protect the compressor from overheated air in a HEAT mode.
8	Indoor fan and outdoor fan stop operation intermittently in a HEAT mode.	The compressor operates in a reverse cycle to remove exterior ice in a HEAT mode, and indoor fan and outdoor fan do not operate intermittently for within 20% of the total heater operation
9	The compressor stops intermittently in a COOL mode or DRY mode, and fan speed of the indoor unit decreases.	The compressor stops intermittently or the fan speed of the indoor unit decreases to prevent inside/outside air frozen depending on the inside/outside air temperature.

- 4) **Indoor unit observes operation condition of the air conditioner, and displays self diagnosis details on the display panel.**

NO	Display	Self Diagnosis
1	Operating LED blinking (1Hz)	Restore from power failure (input initial power)
2	TIMER LED blinking (1Hz)	Indoor unit Room sensor Error (open or short)
3	OPERATING and TIMER LED blinking (1Hz)	Indoor unit heat exchanger temperature sensor Error (open or short)
4	FAN LEA blinking (1Hz)	Indoor fan malfunctioning (for speed is Below 380rpm)

## 5-2 Fault Diagnosis by Symptom

### 5-2-1 No Power (completely dead)-Initial diagnosis

1) Checklist :

- (1) Is input voltage normal? (198-264V~)
- (2) Is AC power linked correctly?
- (3) Are connections between primary side, secondary side of the power transformer and PCB good.
- (4) Is output voltage of DC regulator IC KA7812 (IC01) normal? (11VDC-12.5VDC)
- (5) Is output voltage of DC regulator IC KA7805 (IC02) normal? (4.5VDC-5.5VDC)

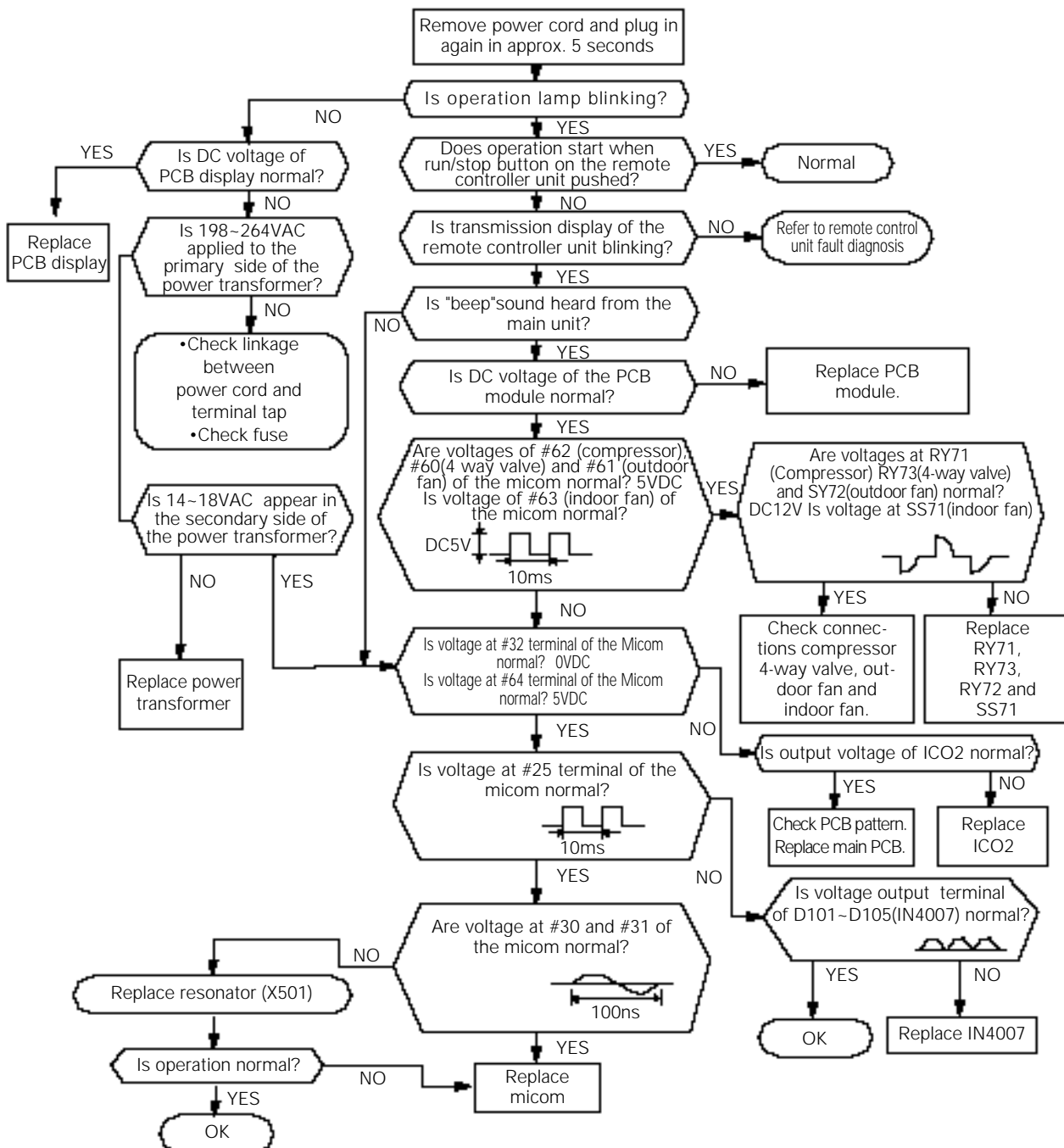

### 5-2-2 When the Indoor Unit Fan Does Not Operate. (Initial Diagnosis)

1) Checklist :

- (1) Is the indoor unit fan motor properly connected with the connector (CN73)?
- (2) Is the AC voltage correct?
- (3) Is HALL IC in indoor fan motor properly connected with the connector (CN43)?
- (4) Is the running capacitor properly connected with the terminal?

2) Troubleshooting procedure

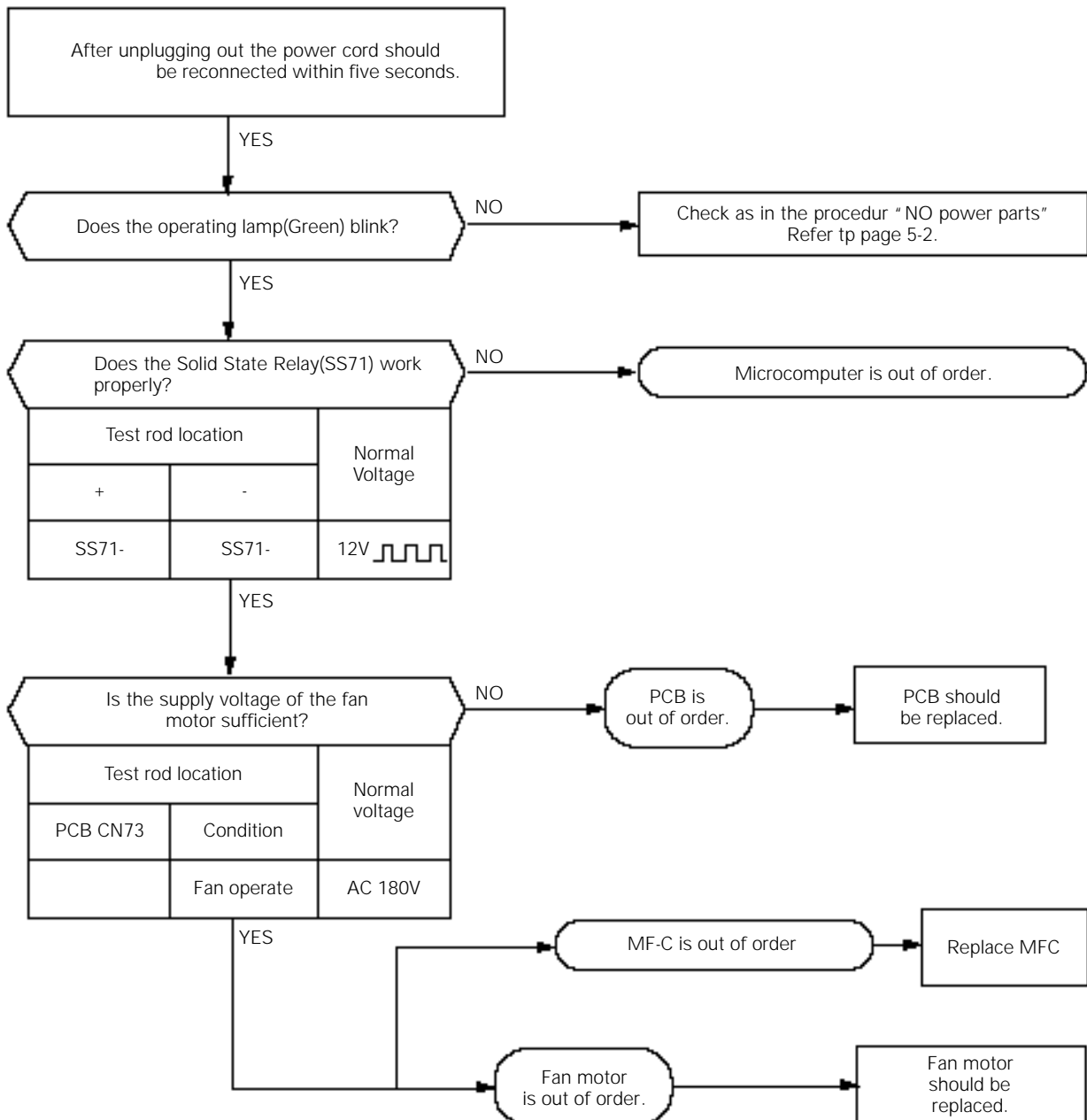

### 5-2-3 When the Outdoor Unit Does Not Operate. (Initial Diagnosis)

1) Checklist :

- (1) Is input voltage normal?(198~264VAC)
- (2) Is the set temperature of the remote control higher than room temperature in COOL mode?
- (3) Is the set temperature of the remote control lower than room temperature in HEAT mode?
- (4) Is the POWER IN connector (terminal-tab) linked correctly?
- (5) Is the outdoor unit properly connected with the TERMINAL BLOCK connector(5P)?

2) Troubleshooting procedure

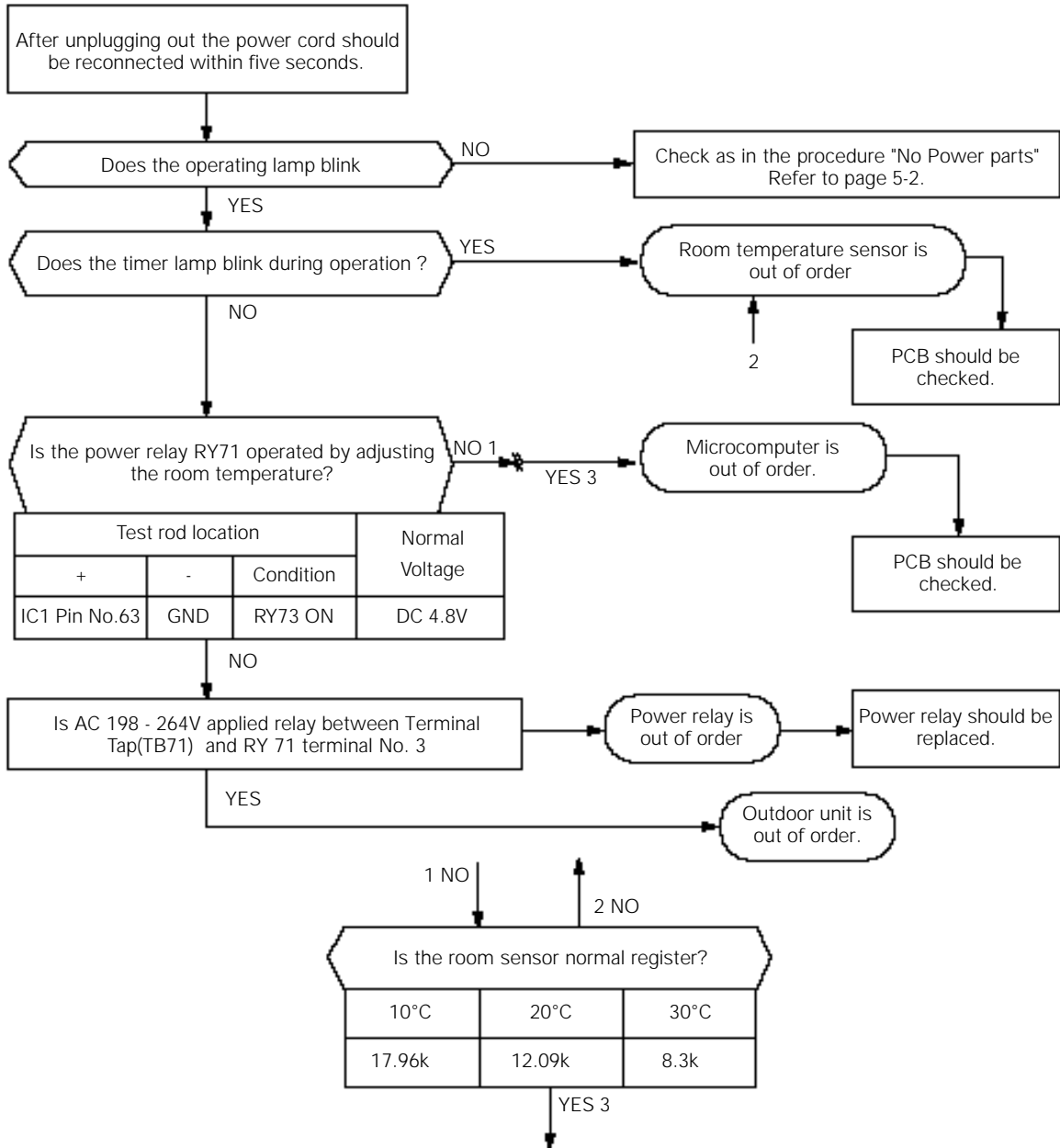

### 5-2-4 When the UP/DOWN Louver Moter Does Not Operate. (Initial Diagnosis)

1) Checklist :

- (1) Is input voltage normal? (198-264VAC)
- (2) Is the UP/DOWN louver motor properly connected with the connector (CN61)?

2) Troubleshooting procedure

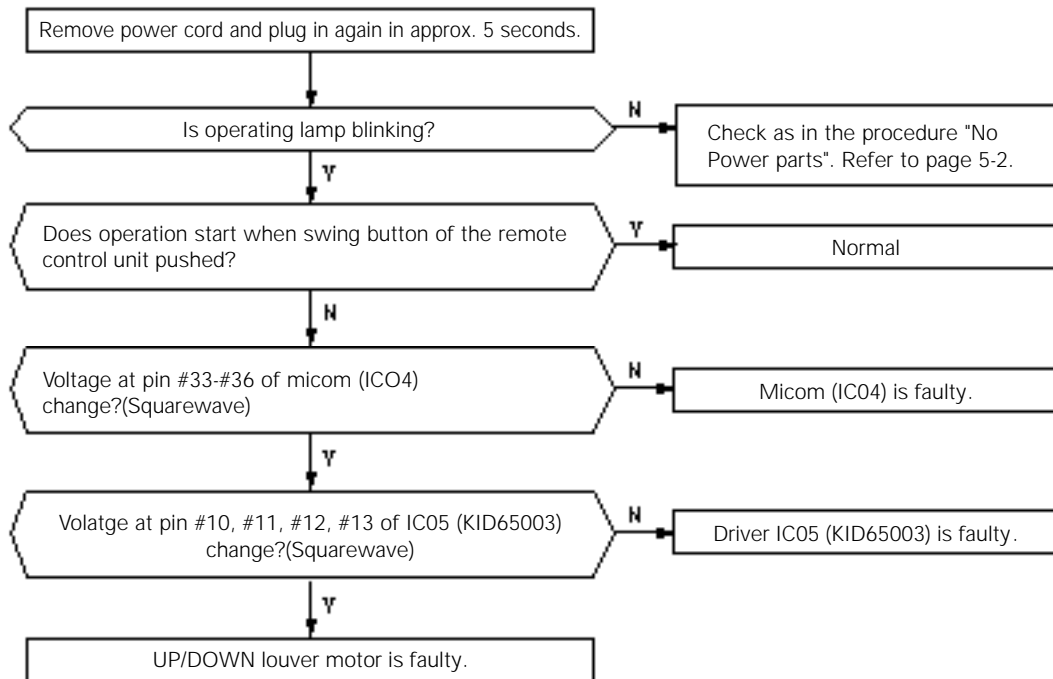

### 5-2-5 In the mode, When there is no warm air current. Check this first;

- (1) Is the set temperature of Remote Control lower than room temperature in Heat mode?
- (2) Is the Indoor PCB properly connected with the CN71 connector?

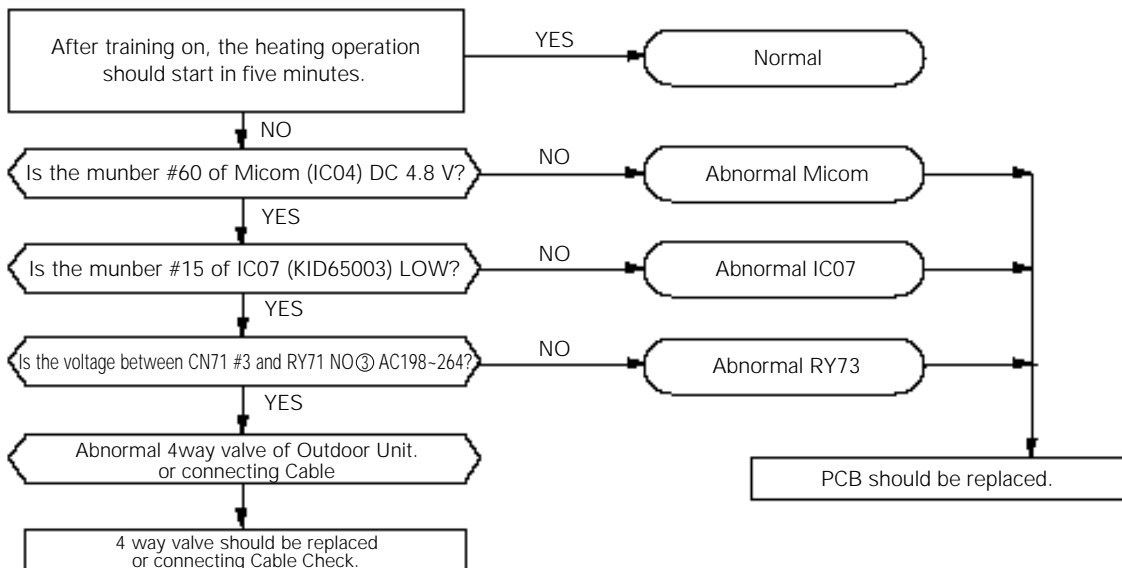

### 5-2-6 If Operation By Remote Control Unit Is Impossible. (Initial Diagnosis)

1) Troubleshooting procedure

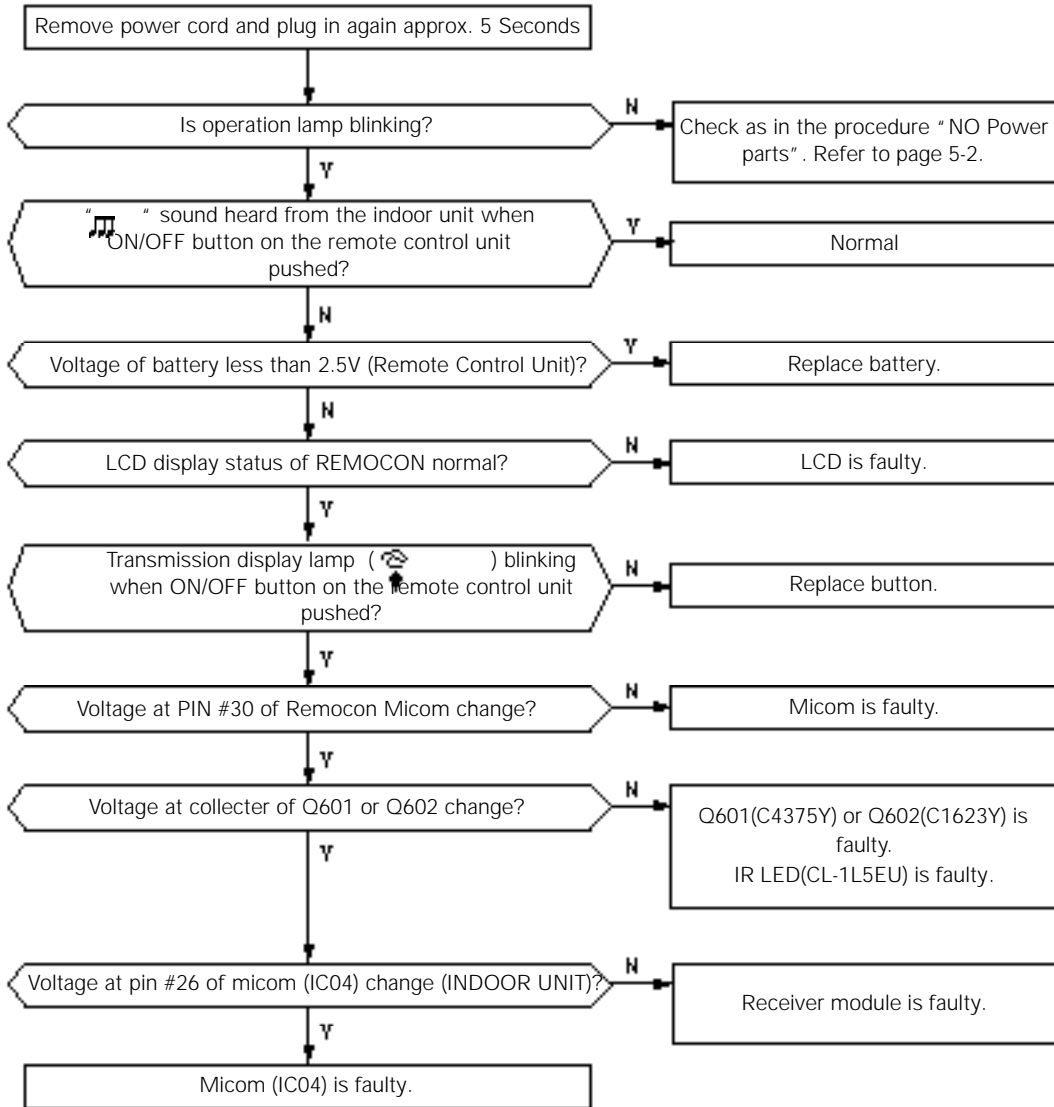

## 5-3 PCB Inspection

---

### 5-3-1 Cautions for Part Replacement

1. The human body carries much static electricity. Before touching a part for repair, replacement or the similar purpose, be sure to touch a grounded metallic portion by hand to let the static electricity go through the metallic portion to the earth. Especially when handling any micro computer or IC, carefully remove such static electricity before touching them.
2. When repairing any part on a work bench, be sure to place an insulative sheet on the bench and always keep the sheet surface neat without any metal fragments. If any such fragment touches a part, a secondary trouble will possibly be caused in the part.
3. Before replacing any parts, be sure to turn off the power supply. If such replacement is done with the power supply kept on, an electric shock, short circuit or destruction of a part may result.
4. During replacement or repair of a part, carefully handle it : The printed circuit board has fine lead wires (jumper wires) and glass-made parts (diode) on its substrate. So if a circuit board is roughly handled, such lead wires and parts will be easily broken or damaged by bending or shock.
5. When soldering the lead wires of any new part, be sure to polish them using an emery paper or the like before soldering them. Since the lead wires of any new part are covered with an oxide film, solder cannot adhere to the lead wires if not polished.
6. When soldering any part, care should be exercised not to apply any high-wattage soldering iron to the part for a long time. Some parts are of so low a heat resistance that they may be broken or have the properties changed if a soldering iron is so applied (Otherwise, the pattern may possibly be separated and raised).
7. The heat of the soldering iron should be transferred to the entire object to be soldered. If the solder pieces are not well fused due to insufficient transfer of the heat from the soldering iron, no satisfactory electrical continuity can be assured even if the soldered objects appear well connected to each other.
8. The solder used should be limited to a minimum. If excessive solder is used, it will cause inter-pattern contact, which may cause malfunction of the circuit.

### 5-3-2 Procedure

The parts should be replaced in the following procedure.

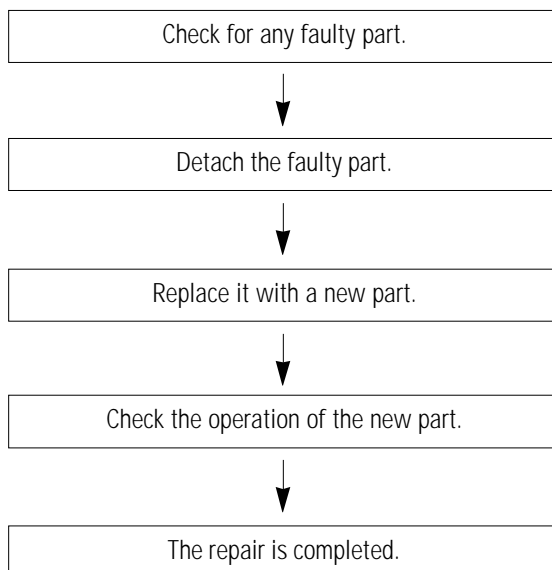

### 5-3-3 Detailed Procedure

No.	Malfunction	Checking point (symptoms)	Causes
1	Pull out the power plug from the AC terminal and confirm the fuse on the PCB assembly	1. Is the broken?	1. Voltage over 2. Indoor unit fan motor short-circuit.
2	Turn the power on. If lamp blinks trouble is not related to the items 1 through 4 on the right.	Voltage check	
		1. AC voltage at both end of transformer Primary? 198 - 264V~	1. Irregular power code or power fuse, or poor wiring.
		2. AC voltage at both end of transformer secondary? 14- 18Vac	2. Transformer is faulty.
		3. DC voltage at OUT and GND of IC01 (KA7812)? 12VDC	3. Power circuit is faulty.
		4. DC voltage at OUT and GND of IC02? 5VDC	4. Power circuit is faulty.
3	Set operating mode when RMC switch pushed. Except for [FAN]mode and [TIMER] mode.	Voltage check	
		1. Voltage of relay (RY71) coil Voltage at pin#10, pin#7 of IC07 : 12VDC	1. Relay(RY 71) coil is open. IC6(ULN2003) is faulty.
		2. Voltage at Terminal Tap (TB71 or 72) and RY71 Terminal NO④. 198- 264V~	2. Relay(RY 71) contactor is faulty.
4	Set operating mode when RMC switch pushed. 1. COOL mode 2. Fan speed [AUTO] 3. Set temperature lower than room temperature 4. Continuously operation.	1. Compressor does not operate.	1. Temperature of Heat exchange is lower. 2. PCB is faulty. 3. Room sensor or Heat exchanger temperature sensor is faulty
5	Set operating mode when RMC switch pushed. 1. HEAT mode 2. Fan speed [AUTO] 3. Set temperature higher than room temperature 4. Continuously operation	1. Compressor does not operate	1. Temperature of Heat exchange is higher. 2. PCB is faulty. 3. Room sensor or Heat exchanger temperature sensor is faulty
6	Set operating mode when RMC switch pushed. 1. [FAN] mode 2. Fan speed [Hi] 3. Continuously operation	1. Voltage at ③⑤ both ends of CN73 : above 180V~	1. Indoor unit fan motor is faulty.
		2. Indoor unit fan motor does not operate.	2. Poor connection of indoor fan motor and connector of RPM sensing (CN43)



## 5-4 Fault Diagnosis of Major Parts

Parts	Diagnosis							
Temp.Sensor	Measure resistance with a tester.							
Heat ex. Sensor	Normal	8K ~27K at ambient temperature (+0°C ~ +30°C)						
	Abnormal	, 0 ... open or short						
Indoor Fan Motor	Measure resistance between terminals (CN72) with a tester							
	Normal	At ambient temperature (10°C ~ 30°C)						
		<table border="1"> <thead> <tr> <th>between</th> <th>Resistance</th> </tr> </thead> <tbody> <tr> <td>Red, Yellow</td> <td>190±10</td> </tr> <tr> <td>Red, Blue</td> <td>170±10</td> </tr> </tbody> </table>	between	Resistance	Red, Yellow	190±10	Red, Blue	170±10
		between	Resistance					
	Red, Yellow	190±10						
	Red, Blue	170±10						
Abnormal								
Measure the voltage between ground and signal wire of the fan motor								
Normal	<table border="1"> <thead> <tr> <th>between</th> <th>Voltage</th> </tr> </thead> <tbody> <tr> <td>Gray, Orange</td> <td>05V~4.5V</td> </tr> <tr> <td>Yellow, Orange</td> <td>5V</td> </tr> </tbody> </table>	between	Voltage	Gray, Orange	05V~4.5V	Yellow, Orange	5V	
	between	Voltage						
	Gray, Orange	05V~4.5V						
Yellow, Orange	5V							
Abnormal	Abnormal if voltage does not change from 0V to 5V.							
Outdoor Fan Motor	Normal	At ambient temperature (10°C ~ 30°C)						
		<table border="1"> <thead> <tr> <th>between</th> <th>Resistance</th> </tr> </thead> <tbody> <tr> <td>Black, White</td> <td>350±10</td> </tr> <tr> <td>Black, Red</td> <td>270±10</td> </tr> </tbody> </table>	between	Resistance	Black, White	350±10	Black, Red	270±10
		between	Resistance					
Black, White	350±10							
Black, Red	270±10							
Abnormal	, 0 ... open or short							
Stepping Motor (UP/DOWN swing motor)	Measure resistance between red wire and each terminal.							
	Normal	Approx. 380 at ambient temperature (20°C ~30°C)						
	Abnormal	, 0 ... open or short						

---

# 6. Exploded Views and Parts List

---

## 6-1 Indoor Unit

---

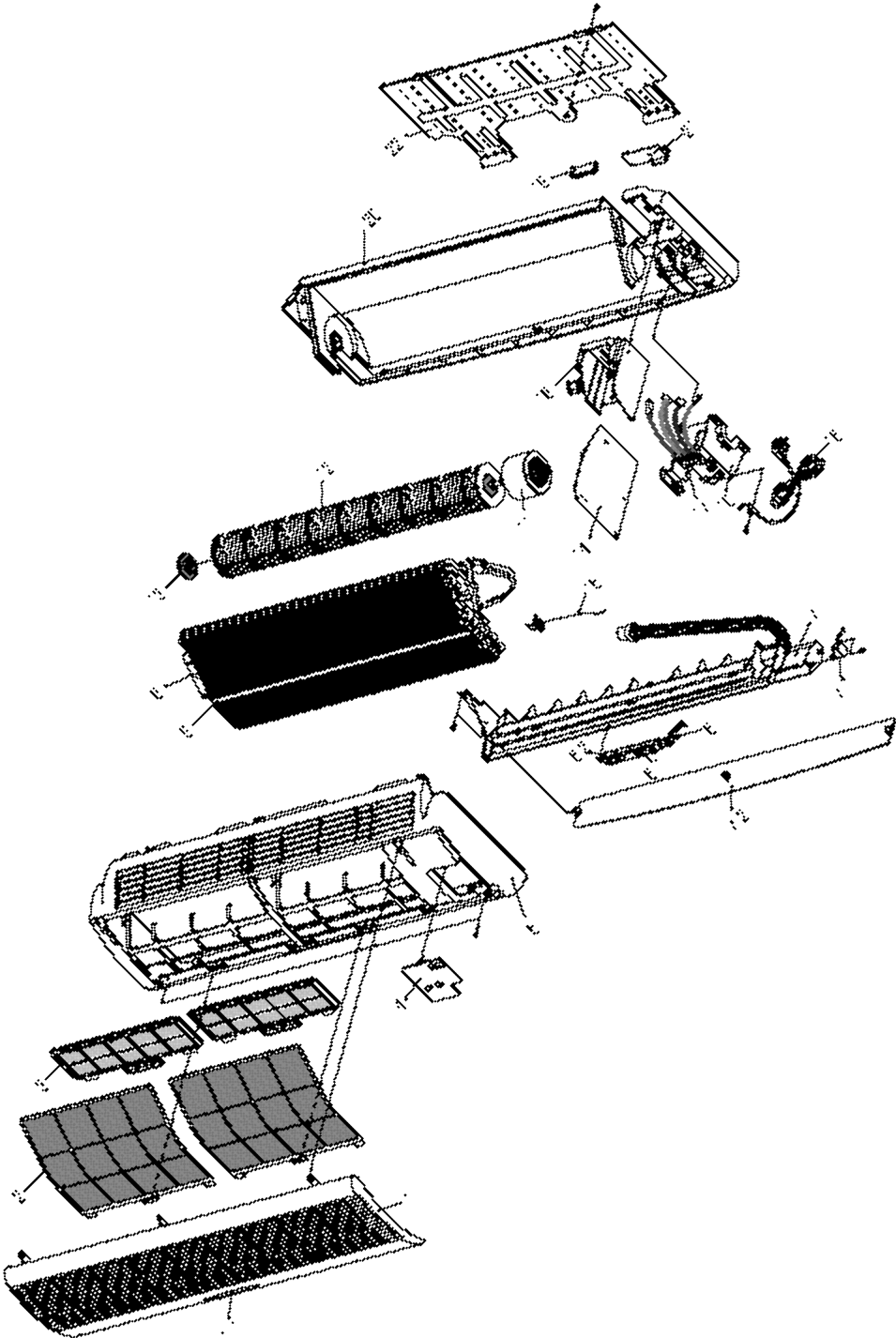

## ■ Parts List

No.	CODE NO	Description	Specification	Q'TY												Remark
				ASH070VE ASH070VD	ASH071VE ASH071VD	ASH074VE ASH074VD	ASH075VE ASH075VD	ASH090VE ASH090VD	ASH091VE ASH091VD	ASH094VE ASH094VD	ASH095VE ASH095VD	ASH120VE ASH120VD	ASH121VE ASH121VD	ASH124VE ASH124VD	ASH125VE ASH125VD	
1	DB64-10140A DB64-10143A	GRILLE AIR INLET "	ABS ABS	1 -	1 -	- 1	- 1	1 -	1 -	- 1	- 1	1 -	1 -	- 1	- 1	
1-1	DB64-70073A DB64-70075A	PANEL CENTER DISPLAY "	PC PC	1 -	1 -	- 1	- 1	1 -	1 -	- 1	- 1	1 -	1 -	- 1	- 1	
2	DB63-30131A	GUARD AIR FILTER	PP	2	2	2	2	2	2	2	2	2	2	2	2	
3	DB74-10091A	ASS'Y FILTER	CLEANER/CARBON	-	1	-	1	-	1	-	1	-	1	-	1	
4	DB63-10472B	COVER TERMINAL	HIPS	1	1	1	1	1	1	1	1	1	1	1	1	
5	DB92-70075C DB92-70081A	ASS'Y FRONT PANEL "	ASS'Y ASS'Y	1 -	1 -	- 1	- 1	1 -	1 -	- 1	- 1	1 -	1 -	- 1	- 1	
6	DB93-10470A DB93-10475A	ASS'Y PCB DISPLAY "	ASS'Y ASS'Y	1 -	1 -	- 1	- 1	1 -	1 -	- 1	- 1	1 -	1 -	- 1	- 1	⚠ ⚠
6-1	DB61-10137A DB61-10143A	CASE CENTER PCB "	PC PC	1 -	1 -	- 1	- 1	1 -	1 -	- 1	- 1	1 -	1 -	- 1	- 1	
6-2	DB41-10199A DB41-10200A	PCB DISPLAY "	ASS'Y ASS'Y	1 -	1 -	- 1	- 1	1 -	1 -	- 1	- 1	1 -	1 -	- 1	- 1	
7	DB94-10074B	ASS'Y TRAY DRAIN	ASS'Y	1	1	1	1	1	1	1	1	1	1	1	1	
7-1	DB95-20138A	ASS'Y STEP MOTOR U/D	DC12V.600GR	1	1	1	1	1	1	1	1	1	1	1	1	⚠
7-2	DB66-30153A	BLADE-H	HIPS	1	1	1	1	1	1	1	1	1	1	1	1	
8	DB75-40072A	ASS'Y EVAP	ASS'Y	-	-	-	-	-	-	-	-	1	1	1	1	
8-1	DB75-40074A	"	ASS'Y	-	-	-	-	1	1	1	1	-	-	-	-	
8-2	DB75-40076A	"	ASS'Y	1	1	1	1	-	-	-	-	-	-	-	-	
9	DB67-30058C	SPACER EVAP	PVC	1	1	1	1	1	1	1	1	1	1	1	1	
10	DB61-40250A	ASS'Y HOLDER MOTOR	ASS'Y	1	1	1	1	1	1	1	1	1	1	1	1	
11	DB31-10078F	MOTOR FAN IN	AMPFS040WTVB	1	1	1	1	1	1	1	1	1	1	1	1	⚠
12	DB94-30141A	ASS'Y-C-F-FAN	Ø95 X 619.4mm	1	1	1	1	1	1	1	1	1	1	1	1	
13	DB94-40017A	ASS'Y BEARING	ASS'Y	1	1	1	1	1	1	1	1	1	1	1	1	
14	DB93-10471A DB93-10485A DB93-10483A	ASS'Y MAIN PCB " "	ASS'Y ASS'Y ASS'Y	- - 1	- - 1	- - 1	- - 1	- 1 -	- 1 -	- 1 -	- 1 -	1 - -	1 - -	1 - -	1 - -	⚠ ⚠ ⚠
15	DB32-10008D	ASS'Y-THERMISTOR	ASS'Y	1	1	1	1	1	1	1	1	1	1	1	1	
16	DB39-10062V	ASS'Y POWER CORD	UCP2	1	1	1	1	1	1	1	1	1	1	1	1	⚠
17	DB65-40052A	ASS'Y TERMINAL BLOCK	ASS'Y	1	1	1	1	1	1	1	1	1	1	1	1	
18	DB61-10136A	CASE CONTROL	ABS	1	1	1	1	1	1	1	1	1	1	1	1	⚠
19	DB61-60093A	BODY-BUSH	HIPS	1	1	1	1	1	1	1	1	1	1	1	1	
20	DB94-20030B	ASS'Y BACK BODY	ASS'Y	1	1	1	1	1	1	1	1	1	1	1	1	
21	DB61-40219A	HOLDER PIPE	HIPS	1	1	1	1	1	1	1	1	1	1	1	1	
22	DB70-10618A	PLATE HANGER	SGCC-M	1	1	1	1	1	1	1	1	1	1	1	1	

## 6-2 Outdoor Unit

---

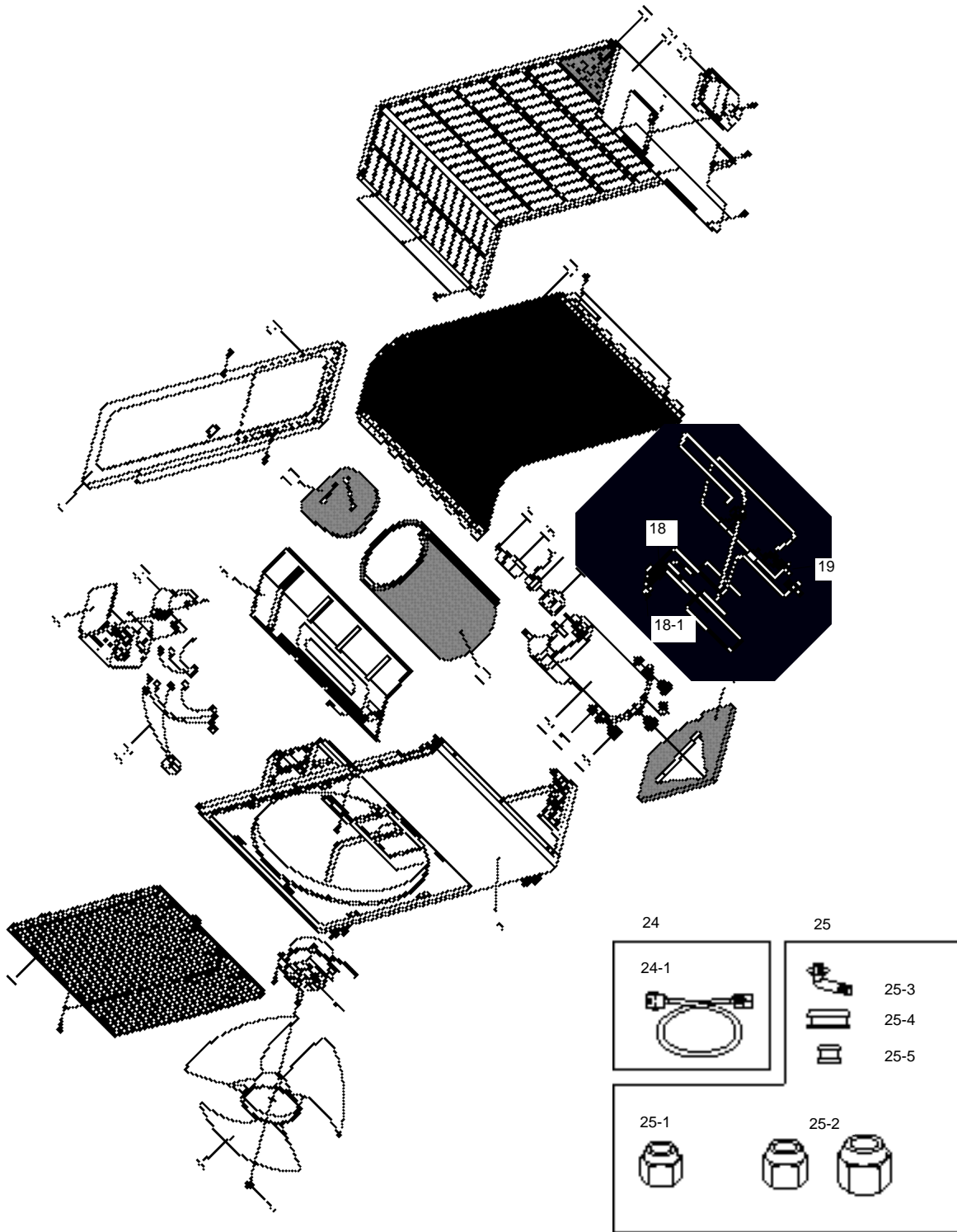

Parts List

No.	CODE NO	Description	Specification	Q'TY						Remark	
				AXH070VE/ASH071VE AXH074VE/ASH075VE	AXH070VD/ASH071VD AXH074VD/ASH075VD	AXH090VE/ASH091VE AXH094VE/ASH095VE	AXH090VD/ASH091VD AXH094VD/ASH095VD	AXH120VE/ASH121VE AXH124VE/ASH125VE	AXH120VD/ASH121VD AXH124VD/ASH125VD		
1	DB63-30004A	GUARD FAN	ABS	1	1	1	1	1	1		
2	DB60-30004A	NUT FLANGE	2C SM20C M6 NTR	1	1	1	1	1	1		
3	DB67-50063A	PROPELLER-FAN	AS+G/F 0405	1	1	1	1	1	1		
4	DB31-10058C DB31-10140B	MOTOR FAN OUT	AMASS020WTVA AMASS015WTVA	- 1	- 1	- 1	- 1	1 -	1 -	△ △	
5	DB90-50009H DB90-50009J	ASS Y FRAME	ASS Y	- 1	- 1	- 1	- 1	1 -	1 -		
6	DB67-30077A DB94-50032B	ASS Y PARTITION	ASS Y	- 1	- 1	- 1	- 1	1 -	1 -		
7	DB64-60138A	CABINET UPPER	SECC-P	1	1	1	1	1	1		
7-1	DB72-50560B	INSU CABI UPPER	FOAM-PE+FOAM-PU	1	1	1	1	1	1		
8	DB91-20074A DB91-20074B DB91-20074C DB91-20074D DB91-20074E DB91-20074F	ASS Y-E PARTS.	ASS Y	- - - - 1 -	- - - - - 1	- - 1 - - -	- - - 1 - -	1 - - - - -	- 1 - - - -		
8-1	2501-001100 2501-001122 2501-001099 2501-001145 2501-001147 2501-001146	CAPACITOR	0.9/30μF 450VAC 1.5/30μF 450VAC 1.5/25μF 450VAC 1.2/30μF 450VAC 1.7/30μF 450VAC 1.7/20μF 450VAC	- - 1 - - -	- - - - - 1	- - - - - -	- - - - 1 -	- - - - - -	1 - - 1 - -	- - - 1 - -	△ △ △ △ △ △
8-2	DB65-40049A	TERMINAL BLOCK	4P	1	1	1	1	1	1		
8-3	DB27-10031A	ASS Y SOLENOID COIL	ASS Y	1	1	1	1	1	1		
8-4	DB39-20376A	COMP & MOTOR WIRE	ASS Y	1	1	1	1	1	1		
8-5	DB47-20001Z DB47-20002B DB47-20001Y DB47-20001V DB47-20002U DB47-20001X	O.L.P.	MRA12030-12008 MST24AMN-12008 MRA12037-12007 MRA98706-12008 MRA12056-12007 MST24AMM-12008	- 1 - - - -	- - - - - 1	- - 1 - - -	- - - - - -	1 - - - - -	- - - 1 - -	- - - 1 - -	△ △ △ △ △ △
8-6	DB67-60020A	O.L.P SPRING	STS304	1	1	1	1	1	1		
9	DB72-50566A DB72-50558A	CLOTH COMP BOTTOM	FELT	- 1	- 1	- 1	- 1	1 -	1 -	- -	
10	DB72-50571A DB72-50516B DB72-50516A	CLOTH COMP SIDE	FELT	- 1 -	- 1 -	- 1 -	- 1 -	1 - -	1 - -	- - -	
11	DB72-50567A	CLOTH COMP UPPER	FELT	1	1	1	1	1	1		
12	DB95-10062X DB95-10065P DB95-10065M DB95-10063C DB95-10065R	COMPRESSOR	48H124JV1E4 44H070JW1E2 44H092JW1E4 48H124MV1E4 44H092MW1E4 44H070MW1E2	- 1 - - - -	- - - - - 1	- - 1 - - -	- - - - 1 -	- - - - - -	- - - 1 - -	1 - - 1 - -	△ △ △ △ △ △
13	DB73-10004A	GROMMET-ISOLATOR	EPDM	3	3	3	3	3	3		
14	DB60-30029A	NUT-WASHER	HEX 2C MB ZPC	3	3	3	3	3	3		
15	DB63-20002A	GASKET	EPDM	1	1	1	1	1	1		
16	DB63-10165B	COVER TERMINAL	NOTYL	1	1	1	1	1	1		
17	DB60-30018A	NUT-FLANGE	M5_SM20C	1	1	1	1	1	1		
18	DB99-10059B DB99-10068A DB99-10094A	ASS Y 4 WAY VALVE	ASS Y	- - 1	- - 1	- - 1	- - 1	1 - -	1 - -	1 - -	
18-1	DB62-40035A	4-WAY VALVE	25kg/cm <sup>2</sup> G	1	1	1	1	1	1		
19	DB99-10076B DB99-10077B DB99-10095A	ASS Y CHECK VALVE	ASS Y	- - 1	- - 1	- - -	- - -	1 - -	1 - -	1 - -	
20	DB96-30260A DB75-30085A DB75-30063A	ASS Y COND	ASS Y(F.P=1.5) ASS Y(F.P=1.3) ASS Y(F.P=1.5)	- - 1	- - 1	- - -	- - -	1 - -	1 - -	1 - -	
21	DB72-50563A	INSU CABI SIDE	FOAMPE+FOAM PU	1	1	1	1	1	1		
22	DB90-10024D	ASS Y CABI SIDE	SECC-P	1	1	1	1	1	1		
23	DB63-10443A	ASS Y COVER E PARTS	ASS Y	1	1	1	1	1	1		
24	DB39-20379A DB39-20381A	ASS Y CABLE BAG	RUBBER	1 3	1 -	1 -	1 -	1 -	1 -	1 -	
25	DB99-90033C DB99-90033D	ASS Y FLARE NUT	1/4" & 1/2"	- 1	- 1	- 1	- 1	1 -	1 -	1 -	
25-1	DB60-30010A	FLARE NUT	1/4"	2	2	2	2	2	2		
25-2	DB60-30010B DB60-30010C	-	3/8" 1/2"	2 -	2 -	2 -	2 -	- 2	- 2	- 2	
25-3	DB67-20008A	DRAIN PLUG	ABS	1	1	1	1	1	1		
25-4	DB63-10354A	CAP DRAIN	CR	1	1	1	1	1	1		
25-5	DB63-10355A	-	CR	1	1	1	1	1	1		

OUTDOOR UNIT

## 6-3 Remote Control & PCB Box

### 6-3-1 Remote Control

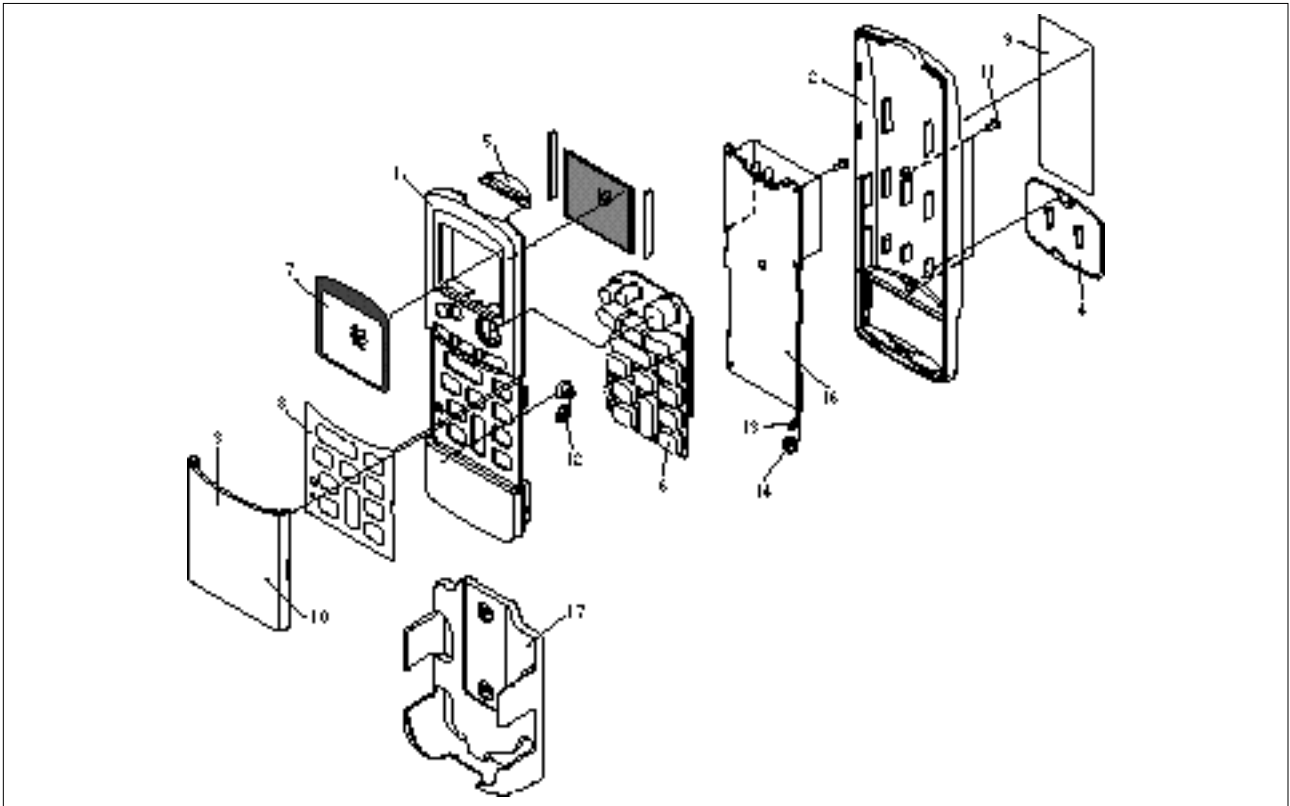

#### ■ Parts List

No	CODE NO	Description	Specification	Q'TY	Remark
	DB93-30052C	ASS'Y CODE			
1	DB61-10144A	CASE UP	ABS	1	
2	DB61-10145A	CASE LOW	ABS	1	
3	DB64-20054A	DOOR REMOCON	ABS	1	
4	DB63-10477A	COVER BATTERY	ABS	1	
5	DB74-10084A	FILTER REMOCON	PC	1	
6	DB73-20110B	RUBBER REMOCON	SILICON	1	
7	DB64-40167A	INLAY LCD	PC	1	
8	DB64-40166B	INLAY REMOCON	PC	1	
9	DB68-10789A	LABEL REMOCON	ART 90	1	
10	DB68-10790A	LABEL DOOR	ART 90	1	
11	PH-M2	SCREW TAP	PH-M2	6	
12	DB67-60061A	SPRING BATTERY	SUS 304	1	
13	DB67-60062A	SPRING BATTERY	SUS 304	1	
14	DB67-60063A	SPRING BATTERY	SUS 304	1	
15	90 x 250	PE BAG	90 x 250	1	
16	DB93-40179C	ASS'Y PCB REMOCON		1	
17	DB61-40243A	HOLDER REMOCON	ABS	1	

## 6-3-2 PCB Box

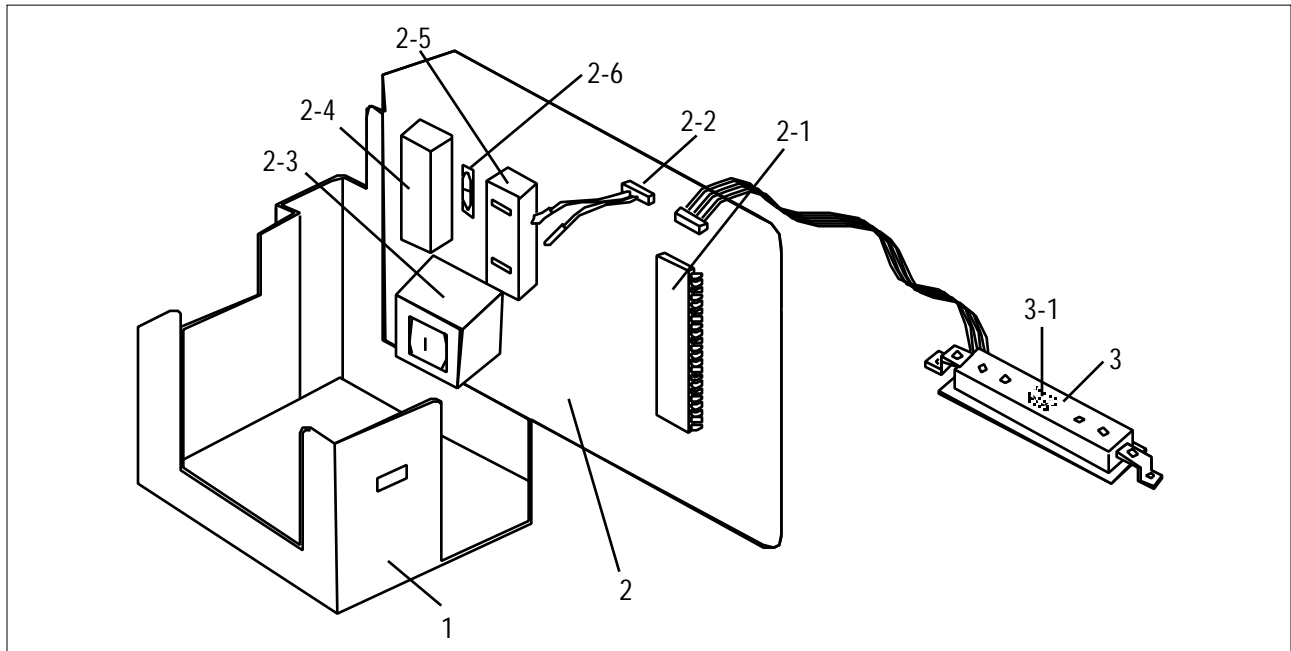

## ■ Parts List

No	CODE NO	Description	Specification	Q'TY			Remark
				7000	9000	12000	
1	DB61-10136A	CASE-CONTROL		1	1	1	
2	DB93-10483A	Ass'y main PCB	-	1	-	-	
	DB93-10485A	Ass'y main PCB	-	-	1	-	
	DB93-10471A	Ass'y main PCB	-	-	-	1	
2-1	DB09-10149A	Micom	MB89635R-466	1	1	1	
2-2	DB32-10008D	Thermistor-EVAP	103AT 240/240	1	1	1	
2-3	DE26-20154A	Trans-power	AC230V DC17V 300mA	1	1	1	
2-4	2306-000294	C-film	CFS 99N 450VAC 155K	1	1	1	
2-5	3501-001058	Power-relay	DI1U DC12V	1	1	1	
2-6	DE32-10037A	Fuse	250V 3.15A	1	1	1	
3	DB93-10470A	Ass'y-display and Remocon Module	-	1	1	1	ASH 070,071 VE/D 090,091 VE/D 120,121 VE/D
	DB93-10475A	Ass'y-display and Remocon Module		1	1	1	ASH 074,075,094,095 124,125 VE/D
3-1	DB32-50021A	Module-remocon	TSOP1238UU1	1	1	1	

# MEMO



# 7. Block Diagrams

## 7-1 Micro Computer Block Diagram

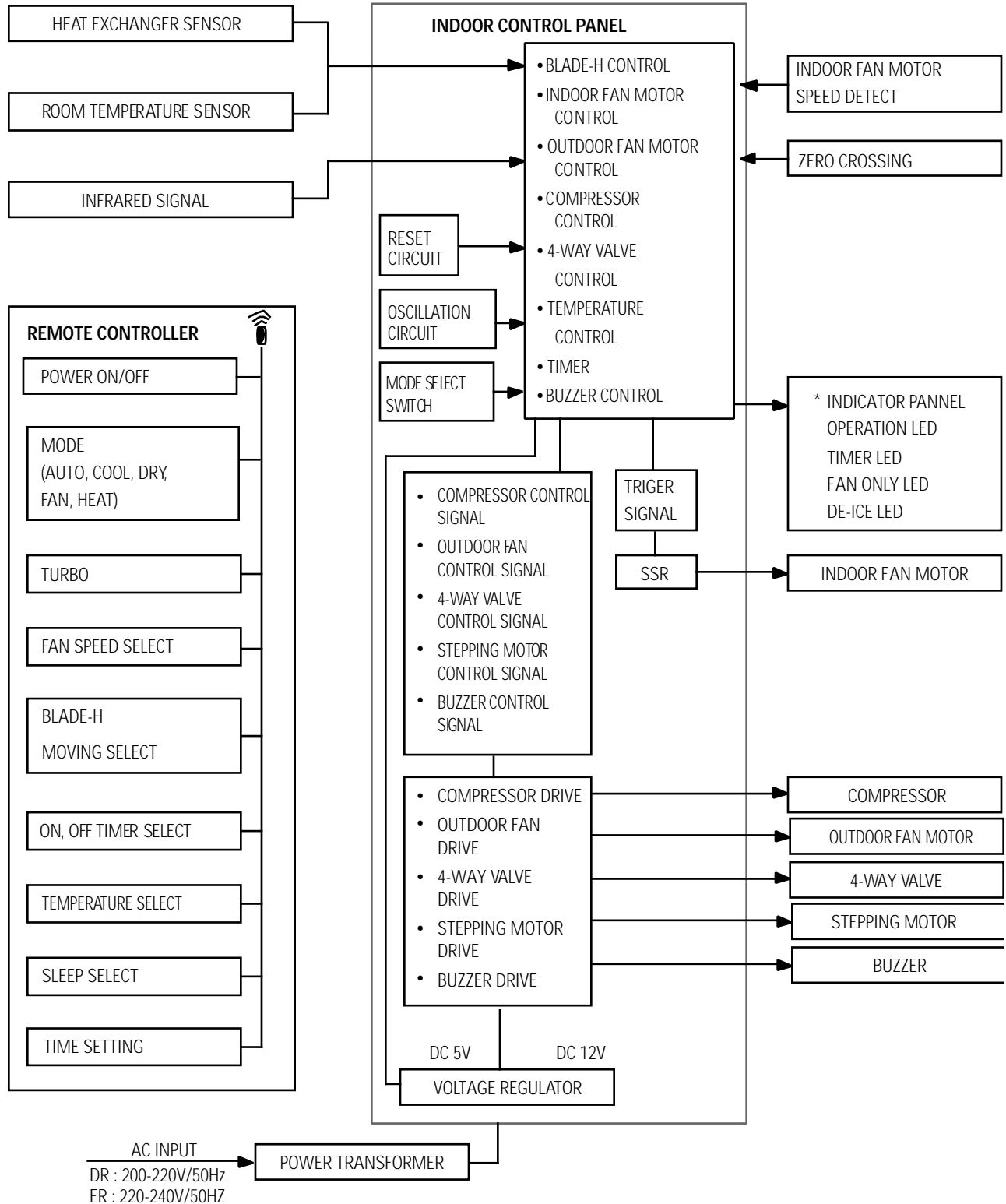

# 8. PCB Diagrams

## 8-1(a) Main PCB-7000Btu(DB93-10483A)

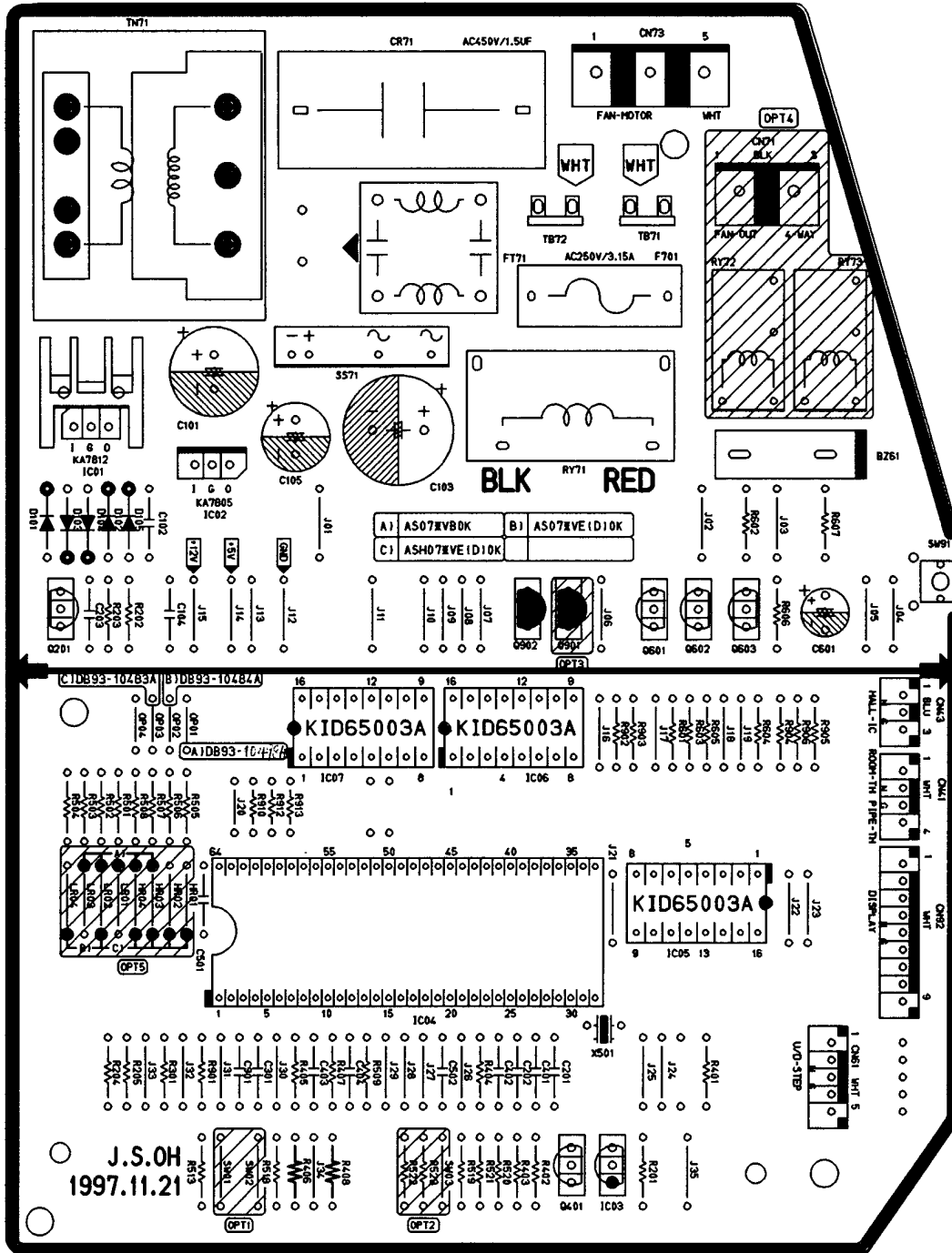

## PART LIST

No	DESIGN LOCATION	CODE NO	Description	Specification	ASH070VE/D	AS070VE/D	AS070VB
					ASH071VE/D	AS071VE/D	AS071VB
					ASH074VE/D	AS074VE/D	AS074VB
					ASH075VE/D	AS075VE/D	AS075VB
					C	B	A
1	F701	DE32-10037A	FUSE	FST 250V 3.15A	1	1	1
2	F701	DE47-40024A	HOLDER-FUSE	FH-51H 7.5A	1	1	1
3	IC01	DE13-20008A	IC-VOLT REGU	KA7812A	1	1	1
4	IC01	DE62-30032A	HEAT-SINK	AL H25	1	1	1
5	IC01	DE60-10100A	SCREW-PH	M3*6 FeFzY	1	1	1
6	IC02	DE13-10016A	IC-VOLT REGU	KA7805A	1	1	1
7	CR71	2306-000294	C-FILM	COS 450V 1.5	1	1	1
8	FI71	DE29-90004A	FILTER NOISE	MD250V 1.6A 6mH	1	1	1
9	R903,904,905,906	2001-000776	R-CARBON	RD 1/2 T(S) 821-J	4	4	4
10	R203	2001-000588	R-CARBON	RD 1/4 TP 332-J	1	1	1
11	R201,204,409,501-509,513,518-521,601,604,606,902	2001-000065	R-CARBON	RD 1/4 TP 103-J	21	21	21
12	R522	DE39-60001A	WIRE SO COPER	P10.6 SN T 52MM	1	1	1
13	R523	2001-000065	R-CARBON	RD 1/4 TP 103-J	1	1	1
14	R405,407	2001-000036	R-CARBON	RD 1/4 TP 331-J	2	2	2
15	R201,204,405,401,402,404,603,606	2001-000042	R-CARBON	RD 1/4 TP 102-J	8	8	8
16	R607	2001-000855	R-CARBON	RD 1/4 TP 560-J	1	1	1
17	R602	2001-001088	R-CARBON	RD 1/2 TP 102-J	1	1	1
18	R403	2001-000890	R-CARBON	RD 1/4 TP 682-J	1	1	1
19	R910,912,913	A1000-0244	R-CARBON	RD 1/8 TP 332-J	3	3	3
20	R406,408	2004-001137	R-METAL FILM	RD 1/4 TP 682-F	2	2	2
21	D101-105	0402-000137	DIODE-RECT	1N4007	5	5	5
22	SS71	B4190-0016	THYRISTOR	G3MB-202PL	1	1	1
23	BZ61	DE30-20016A	BUZZER	CBE 2220BA STICK	1	1	1
24	TN71	DE26-20154A	TRANS L.V	230V DC17V 300mA	1	1	1
25	TN71	DE60-60012A	PIN EYELET	OD2.5 L3.0	5	5	5
26	C202,402	2202-000783	C-CERAMIC	CA OA 50V 103Z	2	2	2
27	C301,401	2202-000796	C-CERAMIC	CA OA 50V 102Z	2	2	2
28	C102,104,201,203,403,404,501,502,902	2202-000780	C-CERAMIC	CA OA 50V 104Z	9	9	9
29	C103	2401-000710	C-ELEC	CE04 25V 222-M	1	1	1
30	C105	2401-001397	C-ELEC	CE 04 25V 471-M	1	1	1
31	C101	2401-000180	C-ELEC	CE 04 35V 102-M	1	1	1
32	C601	2401-001573	C-ELEC	47/50V	1	1	1
33	IC04	DE09-10149A	IC-MCU	MB89635R-466	1	1	1
34	IC03	DE13-20009A	IC	KA7533Z	1	1	1
35	X501	2802-000103	RSONATOR-CERAMIC	10MHz	1	1	1
36	IC05,IC06,IC07	DE13-20024A	IC-DRIVE	KID65003AP	3	3	3
37	Q201,401,601,602	A4050-0168	TR-GENERAL	KSC945Y	4	4	4
38	Q603	0501-000292	TRANSISTOR	A708Y	1	1	1
39	Q902, Q901	0504-000144	TRANSISTOR	R2002	2	1	1
40	SW91	3404-001013	SWITCH-TACT	KPT-1115V	1	1	1
41	CN73	3711-000262	CONNECTOR WAFER	YW396-05AV WHT	1	1	1
42	CN43	3711-000879	CONNECTOR WAFER	SMW250-03 BLU	1	1	1
43	CN41	3711-002662	CONNECTOR WAFER	JSW250-02WHT	1	1	1
44	CN61	3711-000999	CONNECTOR WAFER	SMW250-05 WHT	1	1	1
45	CN62	3711-000997	CONNECTOR WAFER	SMW250-05BLU	1	1	1
46	CN71		CONNECTOR WAFER	YW396-03AV BLK	1	0	0
47	CN92	3711-001154	CONNECTOR WAFER	SMW250-09 WHT	1	1	1
48	TB71,72	DE59-30001A	CONNECTOR-TERMINAL	250TAP,1PIN	2	2	2
49	RY71	3501-001058	RELAY	D11U DC12V	1	1	1
50	RY72,RY72	B3068-0092	RELAY	JQ1a-12V	2	0	0
51	J1-J35	DE39-60001A	WIRE SO COPER	PI0.6 SN T 52MM	35	35	35
52	HR01	DE39-60001A	WIRE SO COPER	PI0.6 SN T 52MM	1	1	0
53	HR02	DE39-60001A	WIRE SO COPER	PI0.6 SN T 52MM	1	1	0
54	HR03	DE39-60001A	WIRE SO COPER	PI0.6 SN T 52MM	1	1	1
55	HR04	DE39-60001A	WIRE SO COPER	PI0.6 SN T 52MM	1	1	1
56	LR01	DE39-60001A	WIRE SO COPER	PI0.6 SN T 52MM	0	0	1
57	LR02	DE39-60001A	WIRE SO COPER	PI0.6 SN T 52MM	1	1	1
58	LR03	DE39-60001A	WIRE SO COPER	PI0.6 SN T 52MM	0	0	1
59	LR04	DE39-60001A	WIRE SO COPER	PI0.6 SN T 52MM	1	1	0
60	SW02	DE39-60001A	WIRE SO COPER	PI0.6 SN T 52MM	1	0	0
61	SW01	DE39-60001A	WIRE SO COPER	PI0.6 SN T 52MM	0	1	1
62	OP01	DE39-60001A	WIRE SO COPER	PI0.6 SN T 52MM	0	0	1
63	OP02	DE39-60001A	WIRE SO COPER	PI0.6 SN T 52MM	0	1	0
64	OP03	DE39-60001A	WIRE SO COPER	PI0.6 SN T 52MM	1	0	0
65	OP04	DE39-60001A	WIRE SO COPER	PI0.6 SN T 52MM	0	0	0

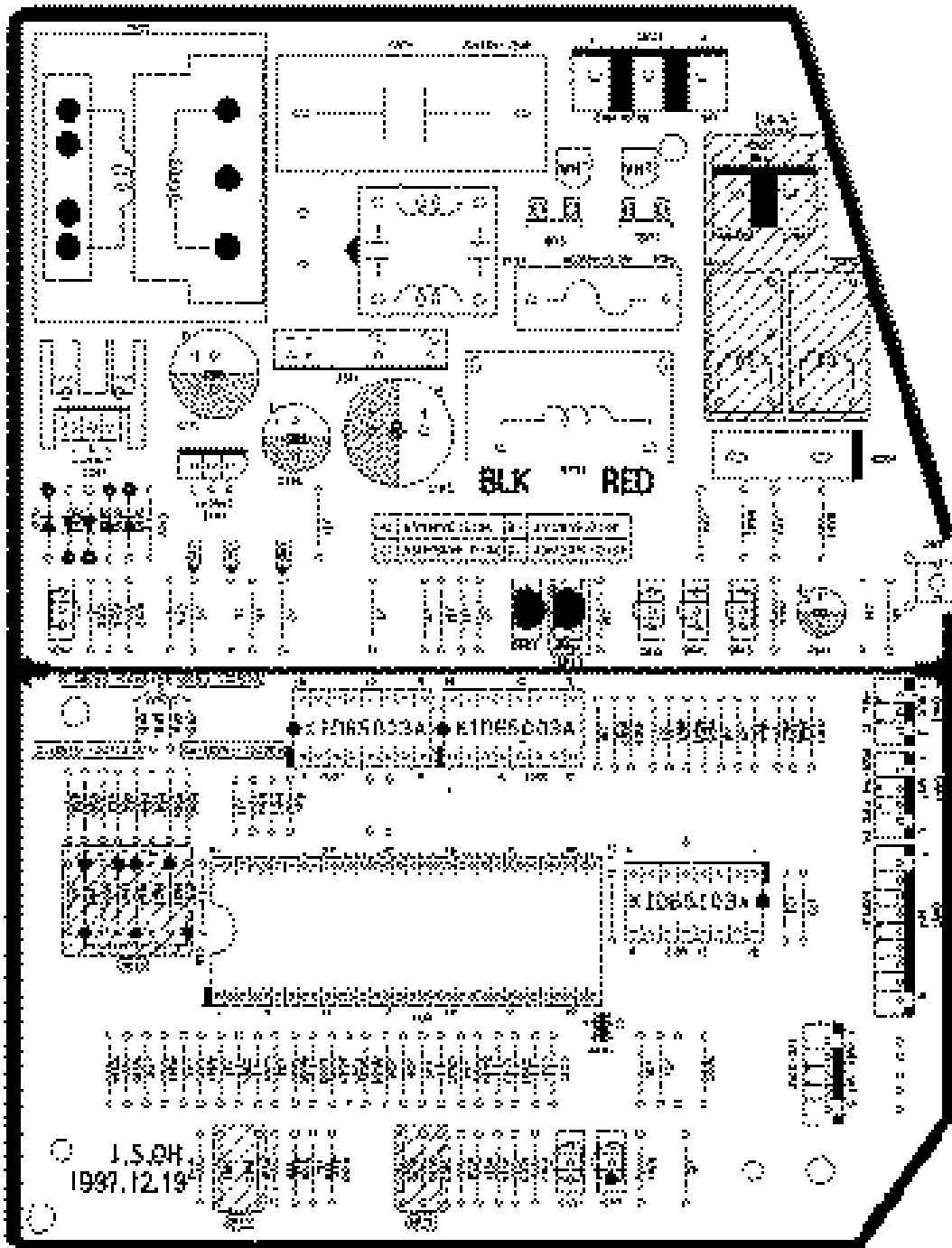

## PART LIST

No	DESIGN LOCATION	CODE NO	Description	Specification	A/S			
					ASH090VE/D ASH091VE/D ASH094VE/D ASH095VE/D C	ASH120VE/D ASH121VE/D ASH124VE/D ASH125VE/D D	AS090VE/D AS091VE/D AS094VE/D AS095VE/D A	AS120VE/D AS121VE/D AS124VE/D AS125VE/D B
1	F701	DE32-10037A	FUSE	FST 250V 3.15A	1	1	1	1
2	F701	DE47-40024A	HOLDER-FUSE	FH-51H 7.5A	1	1	1	1
3	IC01	DE13-20008A	IC-VOLT REGU	KA7812A	1	1	1	1
4	IC01	DE62-30032A	HEAT-SINK	AL H25	1	1	1	1
5	IC01	DE60-10100A	SCREW-PH	M3*6 FeFzY	1	1	1	1
6	IC02	DE13-10016A	IC-VOLT REGU	KA7805A	1	1	1	1
7	CR71	2306-000294	C-FILM	CQS 450V 1.5	1	1	1	1
8	FI71	DE29-90004A	FILTER NOISE	MD250V 1.6A 6mH	1	1	1	1
9	R903,904,905,906	2001-000776	R-CARBON	RD 1/2 T(S) 821-J	4	4	4	4
10	R203	2001-000588	R-CARBON	RD 1/4 TP 332-J	1	1	1	1
11	R202,301,409,501-509,513,518-521,601,604,606,902	2001-000065	R-CARBON	RD 1/4 TP 103-J	21	21	21	21
12	R522	2001-000065	R-CARBON	RD 1/4 TP 103-J	1	1	0	0
13	R523	2001-000065	R-CARBON	RD 1/4 TP 103-J	1	1	0	0
14	R405,407	2001-000036	R-CARBON	RD 1/4 TP 331-J	2	2	2	2
15	R201,204,405,401,402,404,603,606	2001-000042	R-CARBON	RD 1/4 TP 102-J	8	8	8	8
16	R607	2001-000855	R-CARBON	RD 1/4 TP 560-J	1	1	1	1
17	R602	2001-001088	R-CARBON	RD 1/2 TP 102-J	1	1	1	1
18	R403	2001-000890	R-CARBON	RD 1/4 TP 682-J	1	1	1	1
19	R910,912,913	A1000-0224	R-CARBON	RD 1/8 TP 332-J	3	3	3	3
20	R406,408	2004-001137	R-METAL FILM	RD 1/4 TP 682-F	2	2	2	2
21	D101-105	0402-000137	DIODE-RECT	1N4007	5	5	5	5
22	SS71	B4190-0016	THYRISTOR	G3MB-202PL	1	1	1	1
23	BZ61	DE30-20016A	BUZZER	CBE 2220BA STICK	1	1	1	1
24	TN71	DE26-20154A	TRANS LV	230V DC17V 300mA	1	1	1	1
25	TN71	DE60-60012A	PIN EYELET	OD2.5 L3.0	5	5	5	5
26	C202,402	2202-000783	C-CERAMIC	CA OA 50V 103Z	2	2	2	2
27	C301,401	2202-000796	C-CERAMIC	CA OA 50V 102Z	2	2	2	2
28	C102,104,201,203,403,404,501,502,902	2202-000780	C-CERAMIC	CA OA 50V 104Z	9	9	9	9
29	C103	2401-000710	C-ELEC	CE04 25V 222-M	1	1	1	1
30	C105	2401-001397	C-ELEC	CE 04 25V 471-M	1	1	1	1
31	C101	2401-000180	C-ELEC	CE 04 35V 102-M	1	1	1	1
32	C601	2401-001573	C-ELEC	47/50V	1	1	1	1
33	IC04	DE09-10149A	IC-MCU	MB89635R-466	1	1	1	1
34	IC03	DE13-20009A	IC	KA7533Z	1	1	1	1
35	X501	2802-000103	RSONATOR-CERAMIC	10MHz	1	1	1	1
36	IC05,IC06,IC07	DE13-20024A	IC-DRIVE	KID65003AP	3	3	3	3
37	Q201,401,601,602	A4050-0168	TR-GENERAL	KSC945Y	4	4	4	4
38	Q603	0501-000292	TRANSISTOR	A708Y	1	1	1	1
39	Q902, Q901	0504-000144	TRANSISTOR	R2002	2	2	1	1
40	SW91	3404-001013	SWITCH-TACT	KPT-1115V	1	1	1	1
41	CN73	3711-000262	CONNECTOR WAFER	YW396-05AV WHT	1	1	1	1
42	CN43	3711-000879	CONNECTOR WAFER	SMW250-03 BLU	1	1	1	1
43	CN41	3711-002662	CONNECTOR WAFER	JSW250-02WHT	1	1	1	1
44	CN61	3711-000999	CONNECTOR WAFER	SMW250-05 WHT	1	1	1	1
45	CN62	3711-000997	CONNECTOR WAFER	SMW250-05BLU	1	1	1	1
46	CN71		CONNECTOR WAFER	YW396-03AV BLK	1	1	0	0
47	CN92	3711-001154	CONNECTOR WAFER	SMW250-09 WHT	1	1	1	1
48	TB71,72	DE59-30001A	CONNECTOR-TERMINAL	250TAP,1PIN	2	2	2	2
49	RY71	3501-001058	RELAY	D11U DB12V	1	1	1	1
50	RY72,RY72	B3068-0092	RELAY	JQ1a-12V	2	2	0	0
51	J1-J35	DE39-60001A	WIRE SO COPER	PIO.6 SN T 52MM	35	35	35	35
52	HR01	DE39-60001A	WIRE SO COPER	PIO.6 SN T 52MM	0	1	0	1
53	HR02	DE39-60001A	WIRE SO COPER	PIO.6 SN T 52MM	1	0	1	0
54	HR03	DE39-60001A	WIRE SO COPER	PIO.6 SN T 52MM	0	0	0	0
55	HR04	DE39-60001A	WIRE SO COPER	PIO.6 SN T 52MM	1	1	1	1
56	LR01	DE39-60001A	WIRE SO COPER	PIO.6 SN T 52MM	1	0	1	0
57	LR02	DE39-60001A	WIRE SO COPER	PIO.6 SN T 52MM	0	0	0	0
58	LR03	DE39-60001A	WIRE SO COPER	PIO.6 SN T 52MM	1	1	1	1
59	LR04	DE39-60001A	WIRE SO COPER	PIO.6 SN T 52MM	0	0	0	0
60	SW02	DE39-60001A	WIRE SO COPER	PIO.6 SN T 52MM	1	1	0	0
61	SW01	DE39-60001A	WIRE SO COPER	PIO.6 SN T 52MM	0	0	1	1
62	OP01	DE39-60001A	WIRE SO COPER	PIO.6 SN T 52MM	1	0	0	0
63	OP02	DE39-60001A	WIRE SO COPER	PIO.6 SN T 52MM	0	1	0	0
64	OP03	DE39-60001A	WIRE SO COPER	PIO.6 SN T 52MM	0	0	1	0
65	OP04	DE39-60001A	WIRE SO COPER	PIO.6 SN T 52MM	0	0	0	1

## 8-2 ASS'Y DISPLAY & Module

- DB93-10470A : ASH070,071,090,091,120,121VE/D
- DB93-10475A : ASH074,075,094,095,124,125VE/D

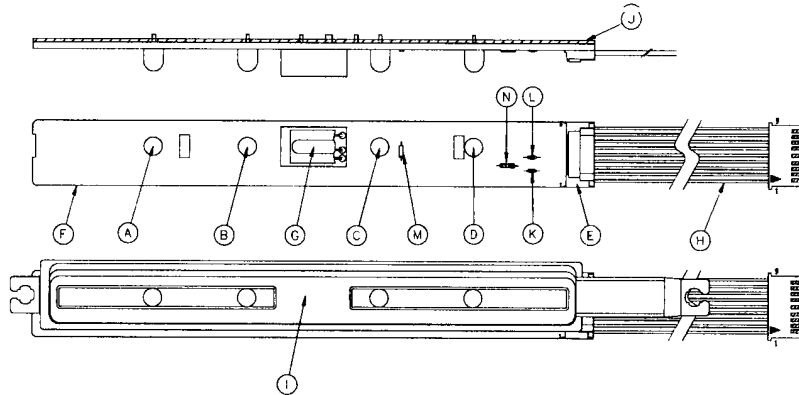

- PCB-DISPLAY (ASH070,071,090,091,120,121VE/D) : DB41-10199A

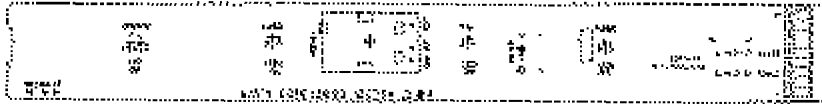

- PCB-DISPLAY (ASH074,075,094,095,124,125VE/D) : DB41-10200A

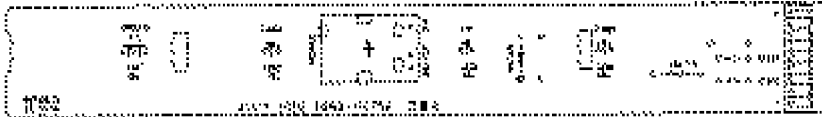

### ■ PART LIST

No	Description	CODE-NO	Specification	Q'TY
A	LED - LAMP	DB07-10022A	LTL-52EG-002(ORG/GRN)	1
B	LED - LAMP	0601-001059	SY5511 (YEL)	1
C	LED - LAMP	0601-001060	SM5511 (GRN)	1
D	LED - LAMP	0601-001196	SO5511 (ORG)	1
E	CONNECTOR WAFER		YWLA200-09P	1
F	PCB-DISPLAY	DB41-10200A	FR-1T1.6 W20L170	1
		DB41-10199A	FR-1T1.6 W20L170	1
G	MODULE REMOCON	DB32-50021A	TSOP-1238UU1	1
H	C/W DIS & MODULE	DB39-20346A	-	1
I	CASE-CENTER PCB	DB61-10143A	ASH074,075,094,095,124,125VE/D	1
		DB61-10137A	ASH070,071,090,091,120,121VE/D	1
J	PAINT		DCR200H(BROWN)	
K	C-CERAMIC	2202-000780	CA OA 50V 104Z	1
L	C-CERAMIC	2201-000283	CA OA 50V 102Z	1
M	DIOD-SWITCHING	0401-000005	1N4148	1
N	R-CARBON	2001-000034	RD 1/4TP 221-J	1

---

## 9. Wiring Diagrams

---

### 9-1 Indoor Unit

---

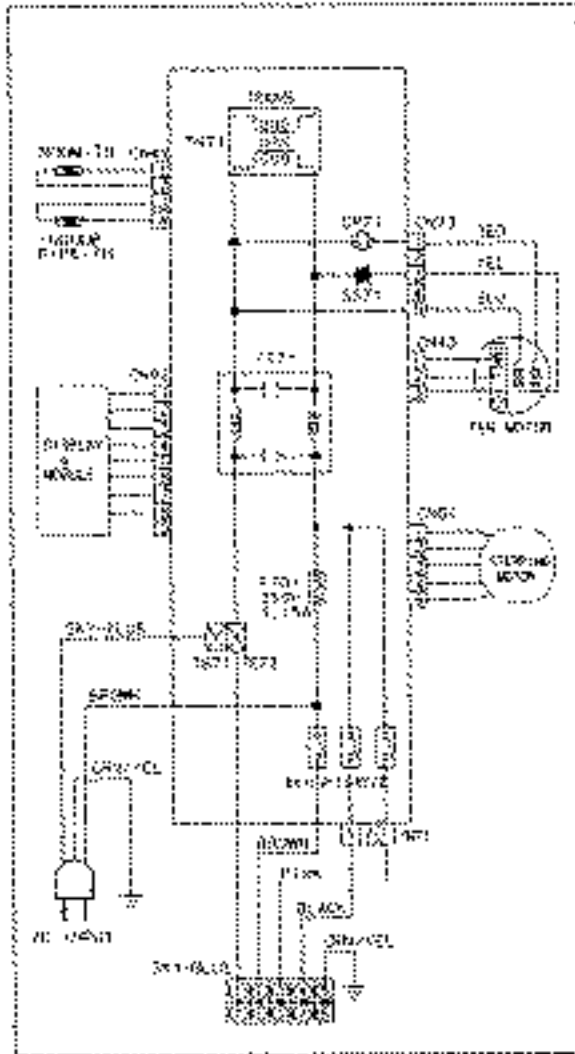

## 9-2 Outdoor Unit

### ■ AXH 120/121/124/125VE

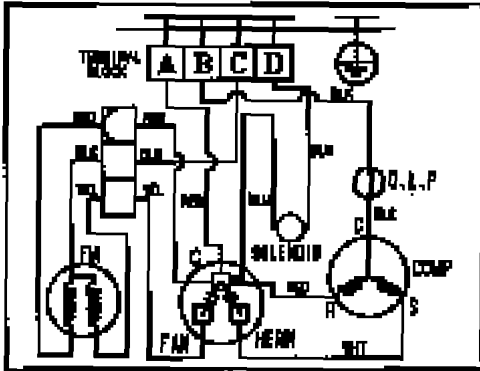

CAPACITOR AXH120/121/124/125VE: 0.9/30 $\mu$ F X 450VAC

### ■ AXH 120/121/124/125VD

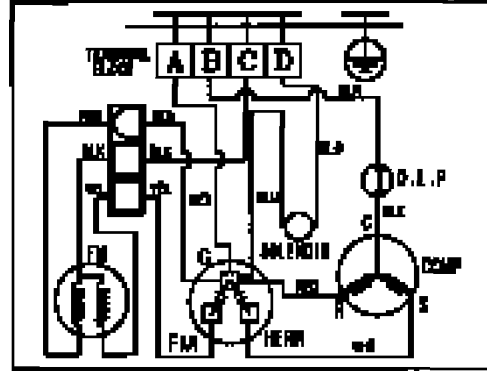

CAPACITOR AXH120/121/124/125VD: 1.2/30 $\mu$ F X 450VAC

### ■ AXH 070/071/074/075VE

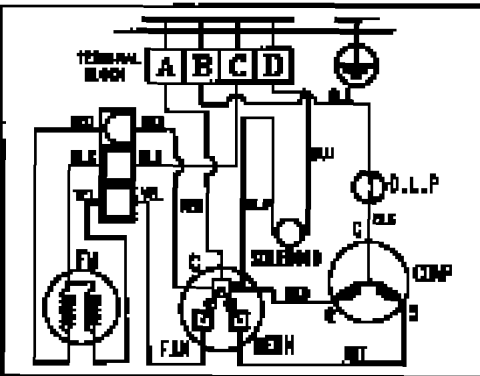

CAPACITOR AXH070/071/074/075VE: 1.5/25 $\mu$ F X 450VAC

### ■ AXH 070/071/074/075VD

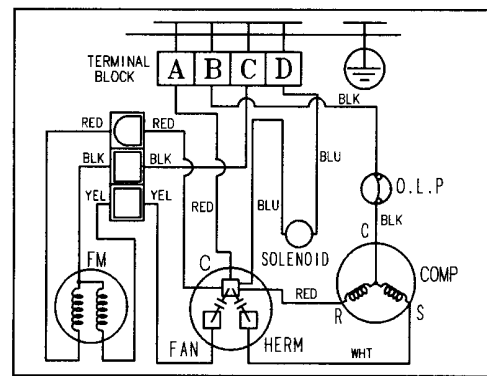

CAPACITOR AXH070/071/074/075VD: 1.7/20 $\mu$ F X 450VAC

### ■ AXH 090/091/094/095VE

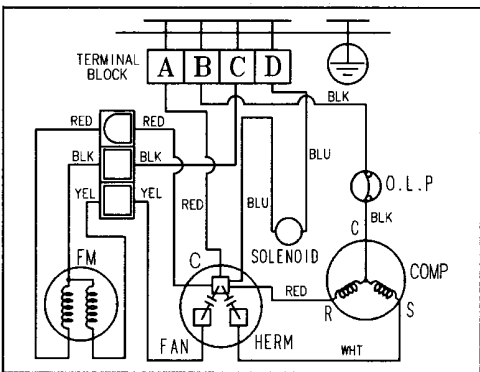

CAPACITOR AXH090/091/094/095VE: 1.5/30 $\mu$ F X 450VAC

### ■ AXH 090/091/094/095VD

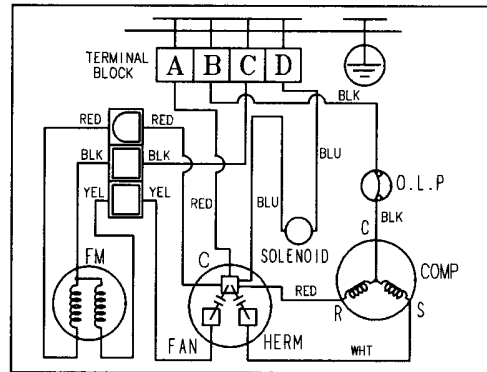

CAPACITOR AXH090/091/094/095VD: 1.7/30 $\mu$ F X 450VAC



# MEMO

# MEMO

# 10. Schematic Diagrams

## 10-1 Indoor Unit

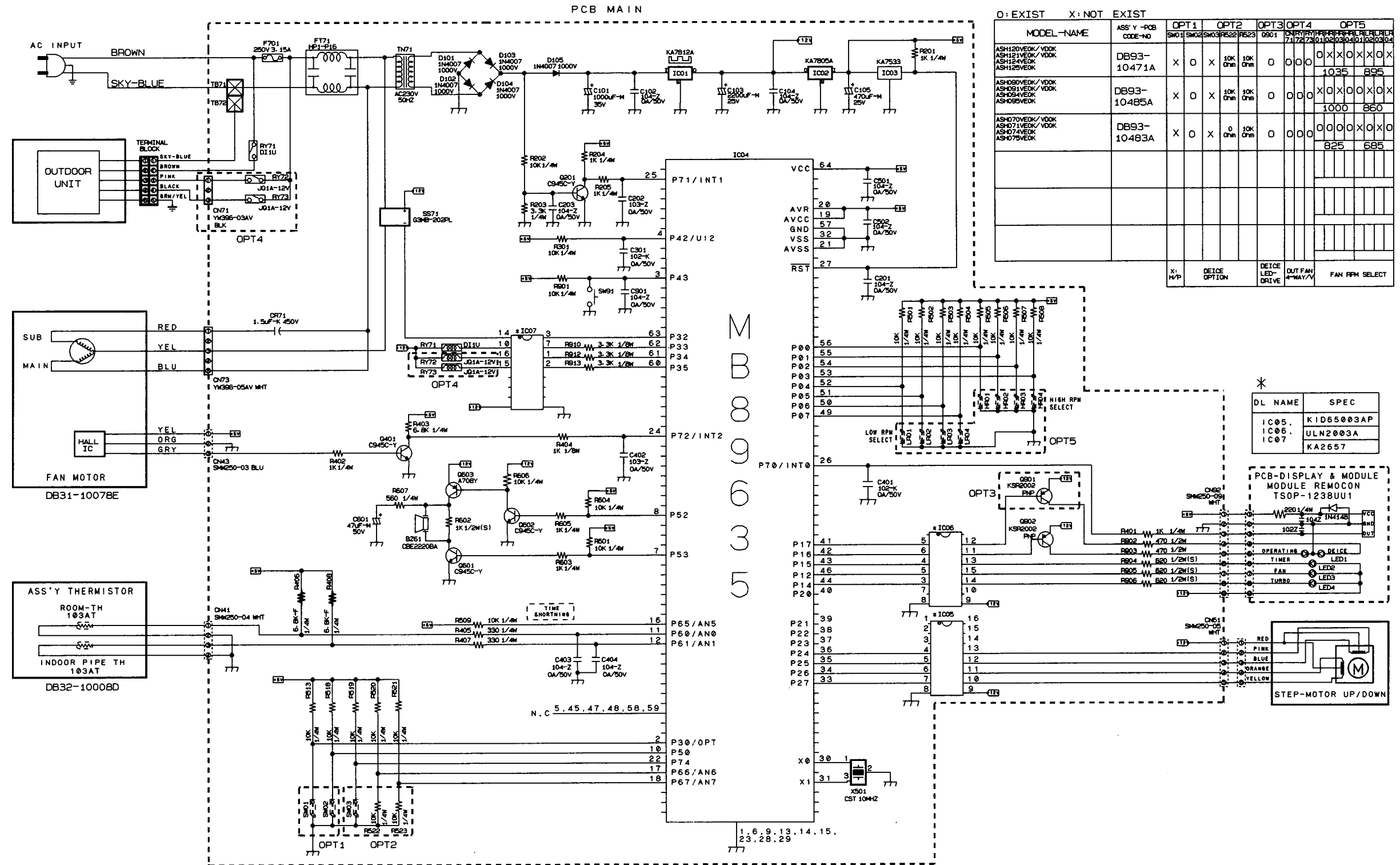

# 10-2 Remote Control

