

Features

- For general purpose switching applications
- Fast switching speed
- High conductance

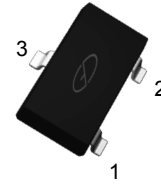

SOT-523

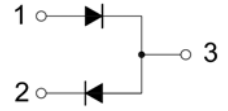

Schematic Diagram

Absolute Maximum Ratings ($T_A=25^{\circ}\text{C}$ unless otherwise noted)

Parameter	Symbol	Value	Unit
Reverse Voltage	V_R	85	V
Forward Current	I_F	75	mA
Non-Repetitive Peak Forward Surge Current@ $t=8.3\text{ms}$	I_{FSM}	2.0	A
Power Dissipation	P_D	150	mW
Thermal Resistance Junction to Ambient	$R_{\theta JA}$	833	$^{\circ}\text{C}/\text{W}$
Junction Temperature	T_J	150	$^{\circ}\text{C}$
Storage Temperature range	T_{STG}	-55 to +150	$^{\circ}\text{C}$

Electrical Characteristics ($T_A=25^{\circ}\text{C}$ unless otherwise noted)

Parameter	Symbol	Test conditions	Min	Max	Unit
Reverse Breakdown Voltage	$V_{(BR)}$	$I_R=1\mu\text{A}$	85	-	V
Reverse Voltage Leakage Current	I_{R1}	$V_R=75\text{V}$	-	2	μA
	I_{R2}	$V_R=25\text{V}$	-	0.03	μA
Forward Voltage	V_F	$I_F=1\text{mA}$ $I_F=10\text{mA}$ $I_F=50\text{mA}$ $I_F=150\text{mA}$	-	715 855 1000 1250	mV
Diode Capacitance	C_D	$V_R=0$ $f=1\text{MHz}$	-	1.5	pF
Reverse Recovery Time	t_{rr}	$I_F=I_R=10\text{mA}$ $I_{rr}=0.1 \times I_R, R_L=100\Omega$	-	4	ns

Typical Electrical Characteristic Curves

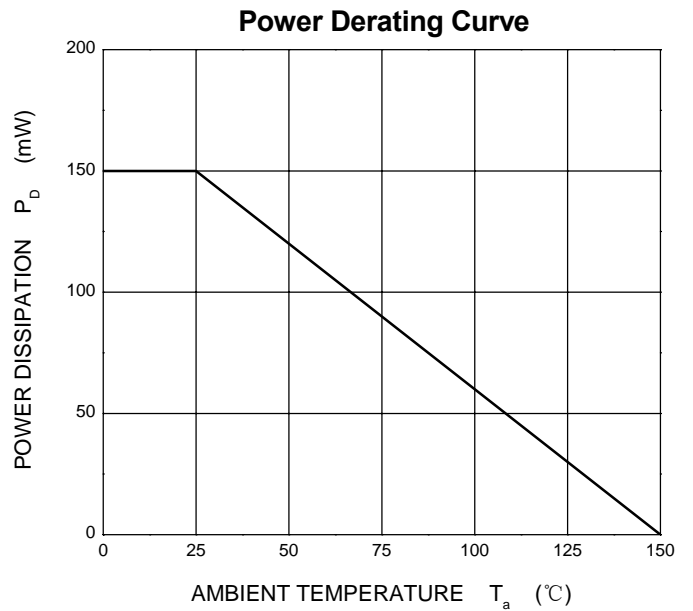
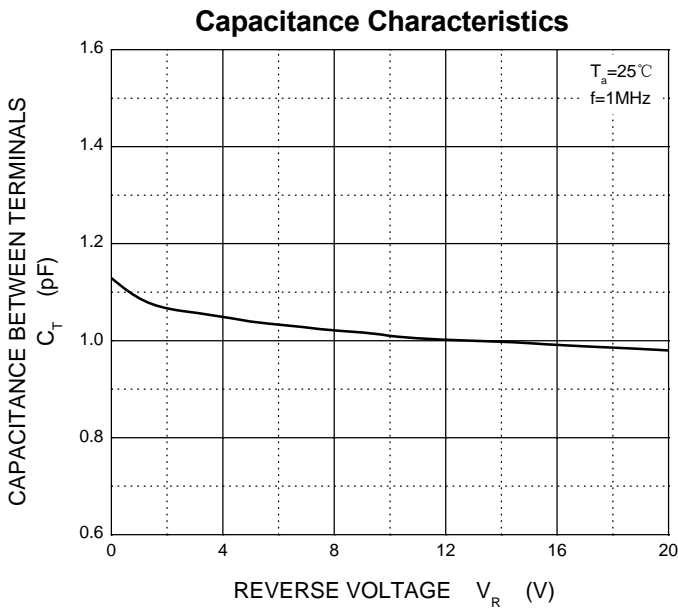
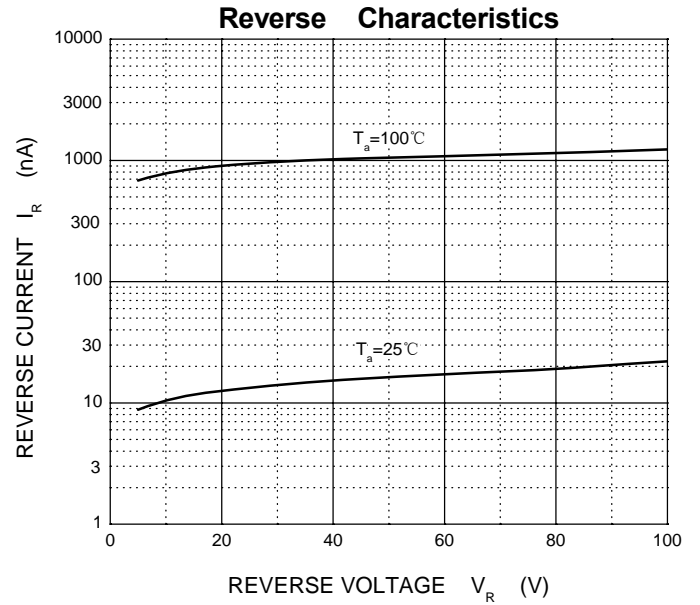
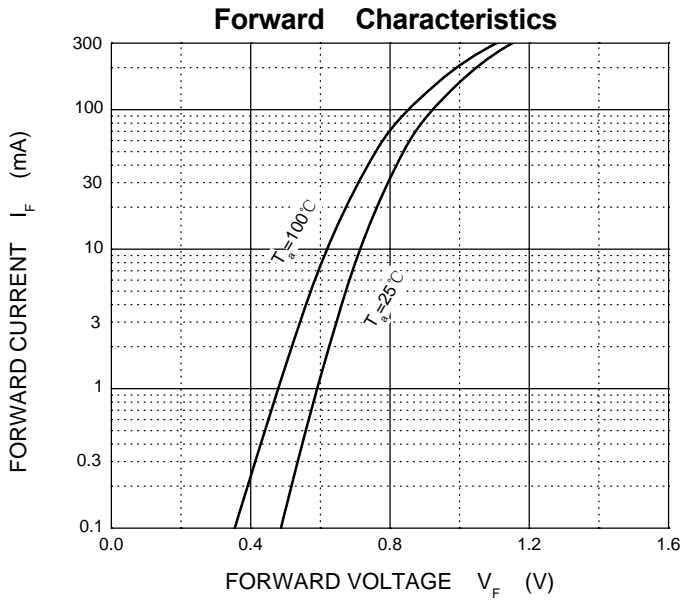

Package Outline Dimensions

SOT-523

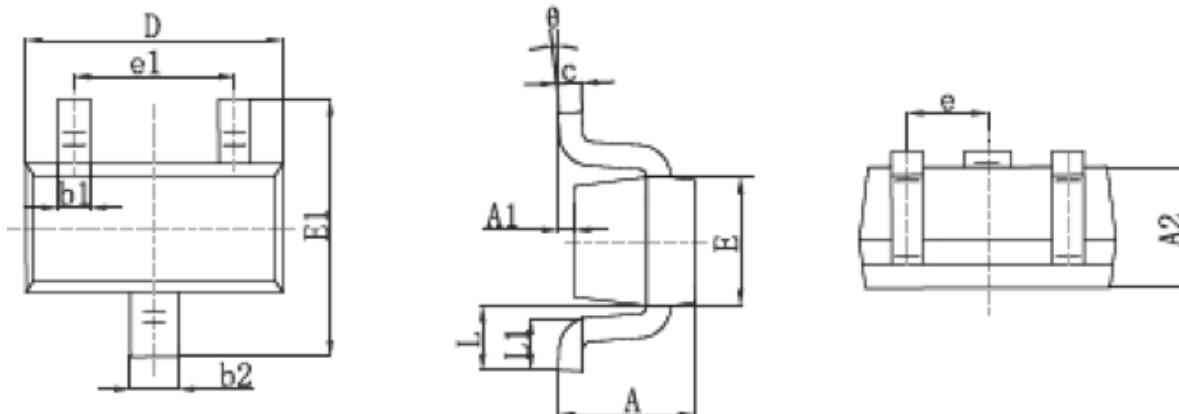

Symbol	Dimensions In Millimeters		Dimensions In Inches	
	Min.	Max.	Min.	Max.
A	0.700	0.900	0.028	0.035
A1	0.000	0.100	0.000	0.004
A2	0.700	0.800	0.028	0.031
b1	0.150	0.250	0.006	0.010
b2	0.250	0.350	0.010	0.014
c	0.100	0.200	0.004	0.008
D	1.500	1.700	0.059	0.067
E	0.700	0.900	0.028	0.035
E1	1.450	1.750	0.057	0.069
e	0.500 TYP.		0.020 TYP.	
e1	0.900	1.100	0.035	0.043
L	0.400 REF.		0.016 REF.	
L1	0.260	0.460	0.010	0.018
θ	0°	8°	0°	8°

Suggested Pad Layout

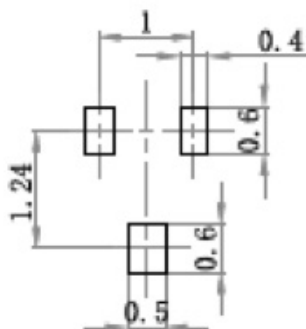

- Note:
1. Controlling dimension: in millimeters.
 2. General tolerance: ±0.05mm.
 3. The pad layout is for reference purposes only.

Order Information

Device	Package	Marking	Quantity	HSF Status
GSBAV99T	SOT-523	JE	3000pcs / Reel	RoHS Compliant/HF