



FEATURES

- PEAK PULSE POWER : 1500 W (10/1000 μ s)
- STAND OFF VOLTAGE RANGE :
From 5V to 188V.
- UNI AND BIDIRECTIONAL TYPES
- LOW CLAMPING FACTOR
- FAST RESPONSE TIME

DESCRIPTION

The SMCJ series are TRANSIL™ diodes designed specifically for protecting sensitive equipment against transient overvoltages.

Transil diodes provide high overvoltage protection by clamping action. Their instantaneous response to transient overvoltages makes them particularly suited to protect voltage sensitive devices such as MOS Technology and low voltage supplied IC's.

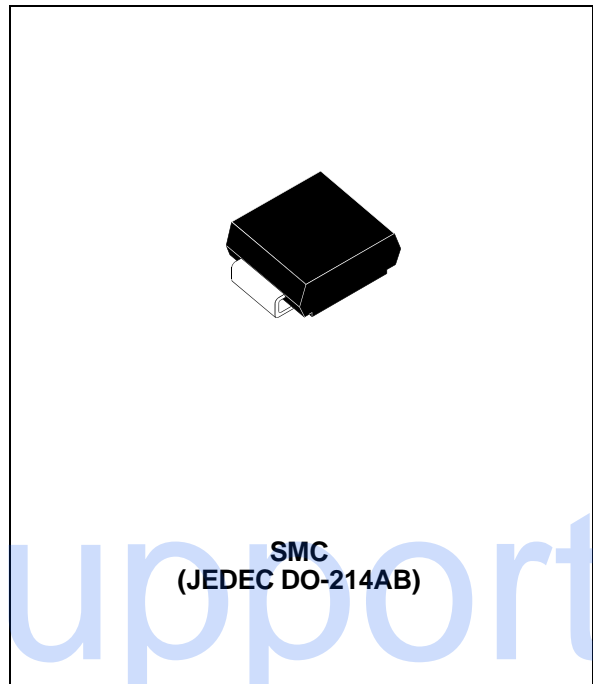

ABSOLUTE MAXIMUM RATINGS ($T_{amb} = 25^{\circ}\text{C}$)

Symbol	Parameter		Value	Unit
P_{PP}	Peak pulse power dissipation (see note 1)	$T_j \text{ initial} = T_{amb}$	1500	W
P	Power dissipation on infinite heatsink	$T_{amb} = 50^{\circ}\text{C}$	6.5	W
I_{FSM}	Non repetitive surge peak forward current for unidirectional types	$t_p = 10\text{ms}$ $T_j \text{ initial} = T_{amb}$	200	A
T_{stg} T_j	Storage temperature range Maximum junction temperature		- 65 to + 175 150	$^{\circ}\text{C}$ $^{\circ}\text{C}$
T_L	Maximum lead temperature for soldering during 10 s.		260	$^{\circ}\text{C}$

Note 1 : For a surge greater than the maximum values, the diode will fail in short-circuit.

THERMAL RESISTANCES

Symbol	Parameter	Value	Unit
$R_{th(j-l)}$	Junction to leads	15	$^{\circ}\text{C/W}$
$R_{th(j-a)}$	Junction to ambient on printed circuit on recommended pad layout	75	$^{\circ}\text{C/W}$

SMCJxxxA-TR, CA-TR

ELECTRICAL CHARACTERISTICS (T_{amb} = 25°C)

Symbol	Parameter
V _{RM}	Stand-off voltage
V _{BR}	Breakdown voltage
V _{CL}	Clamping voltage
I _{RM}	Leakage current @ V _{RM}
I _{PP}	Peak pulse current
α _T	Voltage temperature coefficient
V _F	Forward voltage drop

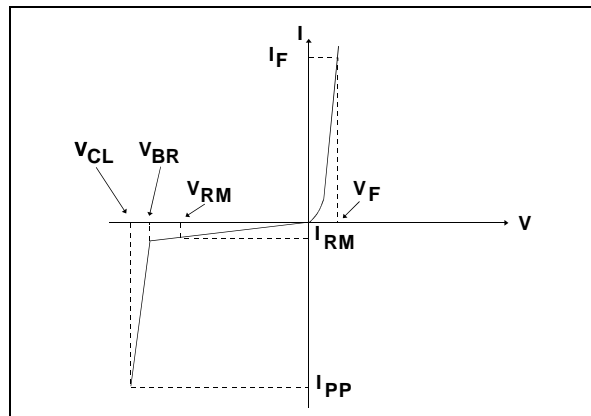

Types				I _{RM} @ V _{RM}		V _{BR} @ I _r		V _{CL} @ I _{PP}		V _{CL} @ I _{PP}		α _T	C
				max		min		max		max		max	typ
Unidirectional	Mark.	Bidirectional	Mark.	μA	V	V	mA	V	A	V	A	10 ⁻⁴ /°C	pF
SMCJ5.0A-TR	FUA	SMCJ5.0CA-TR	FBA	800	5.0	6.4	10	9.2	171	13.4	746	5.7	9500
SMCJ6.0A-TR	FUB	SMCJ6.0CA-TR	FBB	800	6.0	6.7	10	10.3	152	13.7	730	5.9	9000
SMCJ6.5A-TR	FUC	SMCJ6.5CA-TR	FBC	500	6.5	7.2	10	11.2	140	14.5	690	6.1	8500
SMCJ8.5A-TR	FUD	SMCJ8.5CA-TR	FBD	5	8.5	9.4	1	14.4	105	19.5	512	7.3	7000
SMC10A-TR	FUF	SMCJ10CA-TR	FBF	5	10	11.1	1	17	92	21.7	461	7.8	6000
SMCJ12A-TR	FUH	SMCJ12CA-TR	FBH	5	12	13.3	1	19.9	79	25.3	394	8.3	5250
SMCJ13A-TR	FUI	SMCJ13CA-TR	FBI	1	13	14.4	1	21.5	73	27.2	368	8.4	5000
SMCJ15A-TR	FUJ	SMCJ15CA-TR	FBJ	1	15	16.7	1	24.4	64	32.5	308	8.8	4300
SMCJ18A-TR	FUL	SMCJ18CA-TR	FBL	1	18	20	1	29.2	53	39.3	254	9.2	3700
SMCJ20A-TR	FUM	SMCJ20CA-TR	FBM	1	20	22.2	1	32.4	48	42.8	234	9.4	3500
SMCJ22A-TR	FUN	SMCJ22CA-TR	FBN	1	22	24.4	1	35.5	44	48.3	207	9.6	3200
SMCJ24A-TR	FUO	SMCJ24CA-TR	FBO	1	24	26.7	1	38.9	40	50	200	9.6	3050
SMCJ26A-TR	FUP	SMCJ26CA-TR	FBP	1	26	28.9	1	42.1	37	53.5	187	9.7	2900
SMCJ28A-TR	FUQ	SMCJ28CA-TR	FBQ	1	28	31.1	1	45.4	34	59	169	9.8	2700
SMCJ30A-TR	FUR	SMCJ30CA-TR	FBR	1	30	33.3	1	48.4	32	64.3	156	9.9	2500
SMCJ33A-TR	FUS	SMCJ33CA-TR	FBS	1	33	36.7	1	53.3	29	69.7	143	10.0	2400
SMCJ40A-TR	FUU	SMCJ40CA-TR	FBU	1	40	44.4	1	64.5	24	84	119	10.1	2050
SMCJ48A-TR	FUW	SMCJ48CA-TR	FBW	1	48	53.3	1	77.4	20	100	100	10.3	1800
SMCJ58A-TR	FUZ	SMCJ58CA-TR	FBZ	1	58	64.4	1	93.6	16	121	83	10.4	1550
SMCJ60A-TR	GUA	SMCJ60CA-TR	GBA	1	60	66.5	1	96.6	15.7	125	81	10.5	1520
SMCJ70A-TR	GUB	SMCJ70CA-TR	GBB	1	70	77.8	1	113	13.9	146	69	10.5	1350
SMCJ85A-TR	GUE	SMCJ85CA-TR	GBE	1	85	94.4	1	137	11.5	178	56	10.6	1150
SMCJ100A-TR	GUG	SMCJ100CA-TR	GBG	1	100	111	1	162	9.7	212	47	10.7	1000
SMCJ130A-TR	GUI	SMCJ130CA-TR	GBI	1	130	144	1	209	7.5	265	38	10.8	850
SMCJ154A-TR	GUL	SMCJ154CA-TR	GBL	1	154	171	1	246	6.1	317	31.5	10.8	725
SMCJ170A-TR	GUM	SMCJ170CA-TR	GBM	1	170	189	1	275	5.7	353	28	10.8	675
SMCJ188A-TR	GUN	SMCJ188CA-TR	GBN	1	188	209	1	328	4.6	388	26	10.8	625

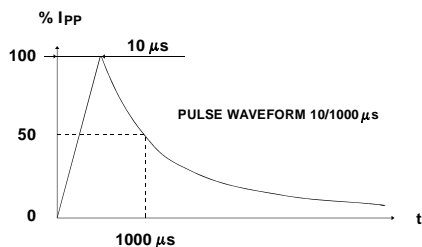

Note 2 : Pulse test : t_p < 50 ms.

Note 3 : ΔV_{BR} = α_T * (T_{amb} - 25) * V_{BR}(25°C).

Note 4 : V_R = 0 V, F = 1 MHz. For bidirectional types, capacitance value is divided by 2.

ORDER CODE

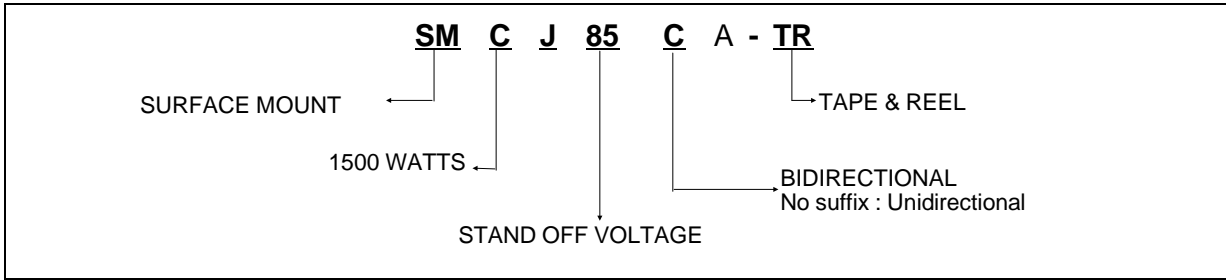

Fig. 1: Peak power dissipation versus initial junction temperature.

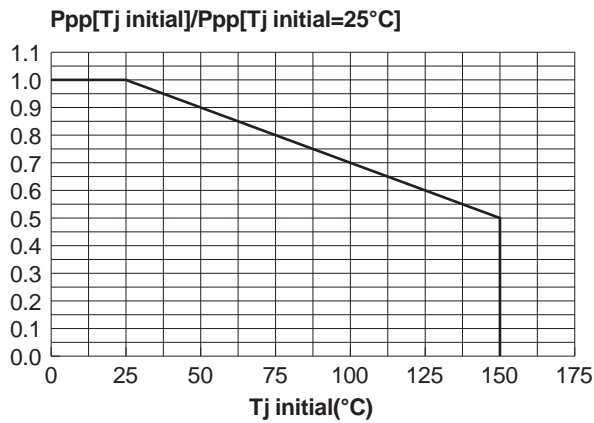

Fig. 2: Continuous power dissipation versus initial junction temperature.

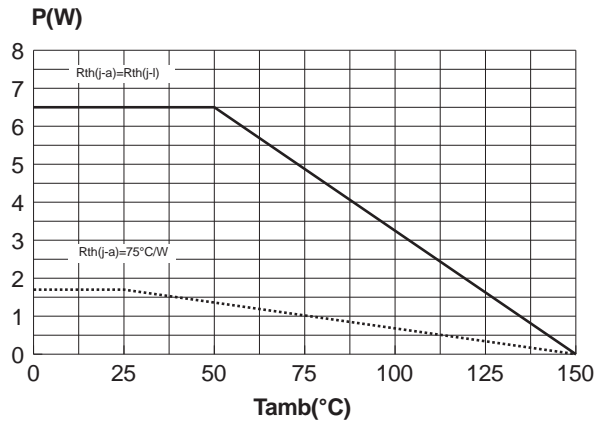

Fig. 3: Peak pulse power versus exponential pulse duration (Tj initial=25°C).

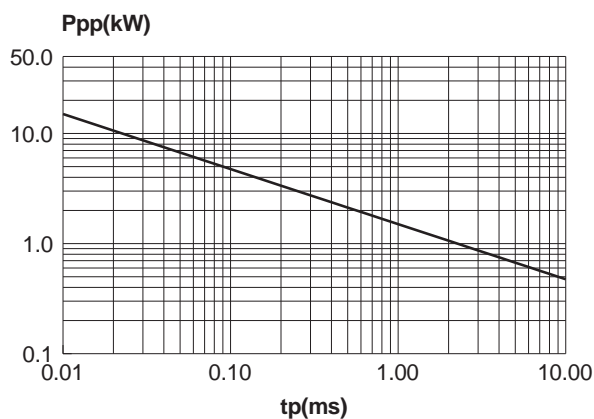

Fig. 4: Clamping voltage versus peak pulse current (Tj initial=25°C). Exponential waveform tp=20µs & tp=1ms.

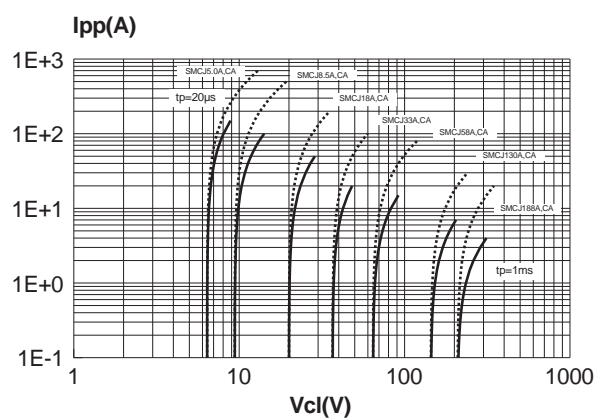

Fig. 5-1: Capacitance versus reverse applied voltage (typical values) (SMCJxxA serie).

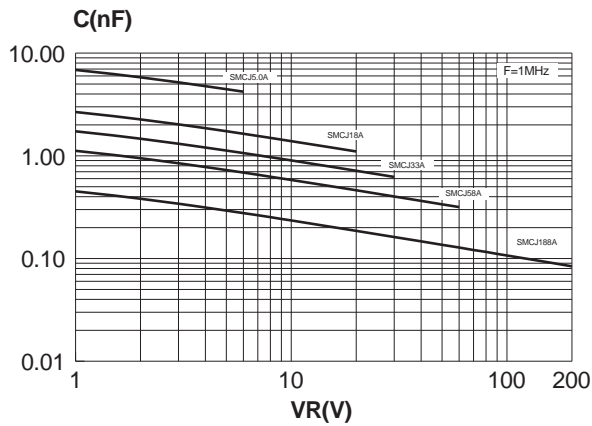

Fig. 5-2: Capacitance versus reverse applied voltage (typical values) (SMCJxxCA serie).

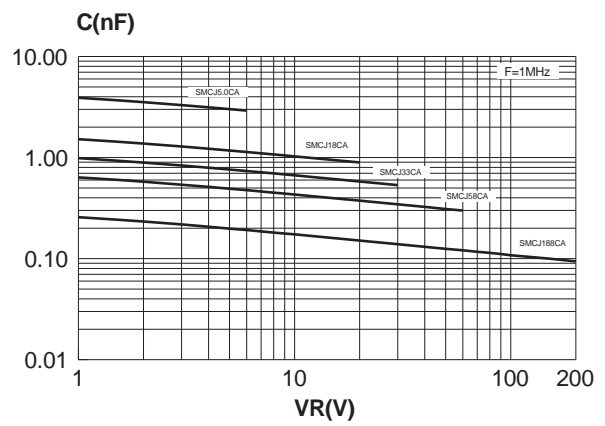

Fig. 6: Peak forward voltage drop versus peak forward current (typical values).

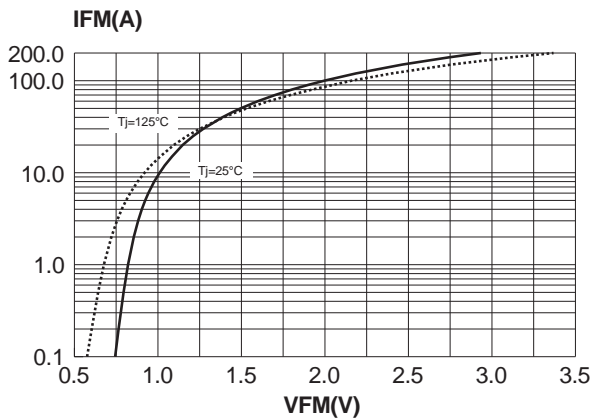

Fig. 7: Relative variation of thermal impedance junction to ambient versus pulse duration. (Printed circuit board FR4, S(Cu)=1cm²).

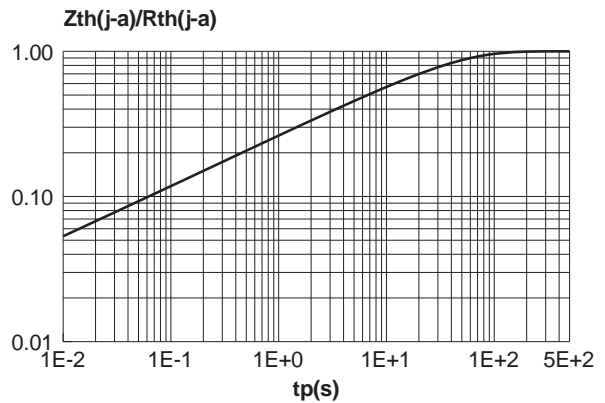

Fig. 8: Thermal resistance junction to ambient versus copper surface under each lead (Printed circuit board FR4, e(Cu)=35µm)

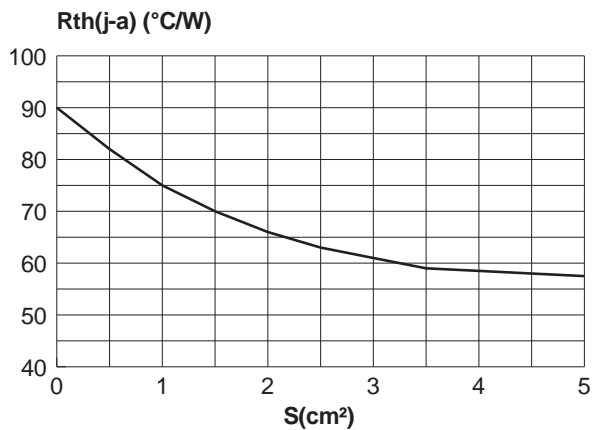
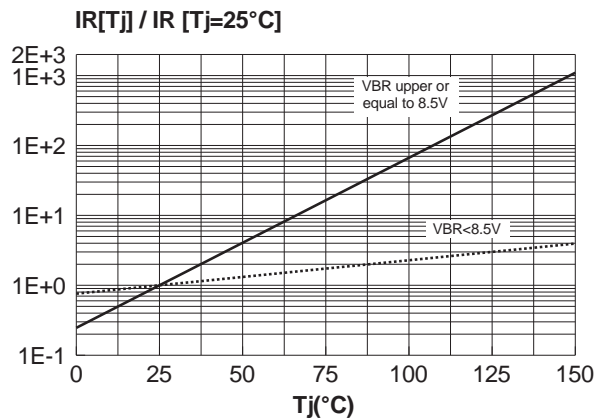
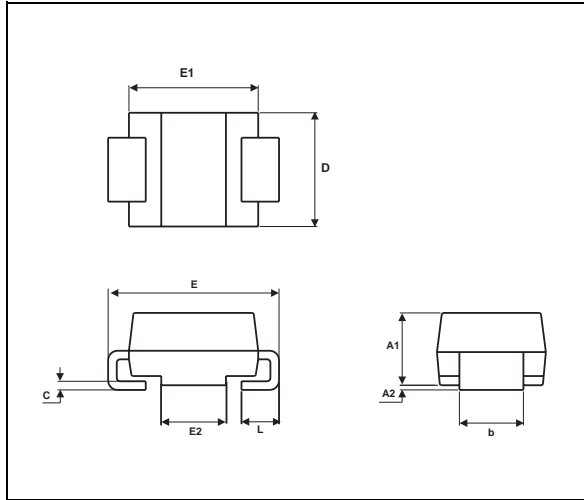

Fig. 9: Relative variation of leakage current versus junction temperature.



MARKING : Logo, Date Code, Type Code, Cathode Band (for unidirectional types only).

PACKAGE MECHANICAL DATA
SMC (Plastic)



REF.	DIMENSIONS			
	Millimeters		Inches	
	Min.	Max.	Min.	Max.
A1	1.90	2.45	0.075	0.096
A2	0.05	0.20	0.002	0.008
b	2.90	3.2	0.114	0.126
c	0.15	0.41	0.006	0.016
E	7.75	8.15	0.305	0.321
E1	6.60	7.15	0.260	0.281
E2	4.40	4.70	0.173	0.185
D	5.55	6.25	0.218	0.246
L	0.75	1.60	0.030	0.063

FOOTPRINT DIMENSIONS (Millimeter)
SMC Plastic.

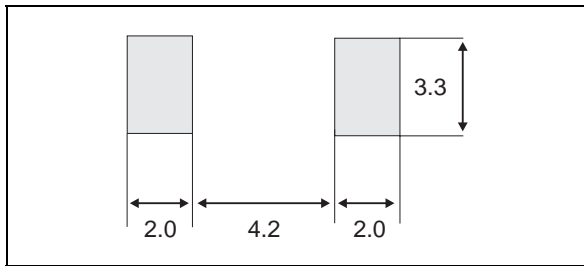

Packaging : standard packaging is in tape and reel.

Weight : 0.25 g

Information furnished is believed to be accurate and reliable. However, STMicroelectronics assumes no responsibility for the consequences of use of such information nor for any infringement of patents or other rights of third parties which may result from its use. No license is granted by implication or otherwise under any patent or patent rights of STMicroelectronics. Specifications mentioned in this publication are subject to change without notice. This publication supersedes and replaces all information previously supplied. STMicroelectronics products are not authorized for use as critical components in life support devices or systems without express written approval of STMicroelectronics.

The ST logo is a registered trademark of STMicroelectronics

© 1999 STMicroelectronics - Printed in Italy - All rights reserved.

STMicroelectronics GROUP OF COMPANIES

Australia - Brazil - China - Finland - France - Germany - Hong Kong - India - Italy - Japan - Malaysia
Malta - Morocco - Singapore - Spain - Sweden - Switzerland - United Kingdom - U.S.A.

<http://www.st.com>

