

SS

Subminiature Snap Action Switch



- Two split spring design offers long life (30 million operations)
- wide variety of operating forces, including super low force
- Solder, quick-connect (#110) and PCB terminals available
- UL, CSA, VDE approvals
- microvoltage to high-capacity loads(10.1 A) versions
- ROHS Compliant

| Part | Rated Resistive Load - Switch | Actuator types | Contact form | Operating Force | Seal type | Termination Style | Service Life - Electrical (Min. @ Rated Loads) |
|----------|-------------------------------|----------------|--------------|-----------------|-----------|-----------------------------------|--|
| SS-01 | 0.1A @ 125VAC/0.1A @ 30VDC | Pin plunger | SPDT | 150g | Unsealed | Solder | 200,000 ops |
| SS-01D | 0.1A @ 125VAC/0.1A @ 30VDC | Pin plunger | SPDT | 150g | Unsealed | Through-Hole PCB - Straight | 200,000 ops |
| SS-01D1 | 0.1A @ 125VAC/0.1A @ 30VDC | Pin plunger | SPDT | 150g | Unsealed | Through-Hole PCB - parallel left | 200,000 ops |
| SS-01D2 | 0.1A @ 125VAC/0.1A @ 30VDC | Pin plunger | SPDT | 150g | Unsealed | Through-Hole PCB - parallel right | 200,000 ops |
| SS-01T | 0.1A @ 125VAC/0.1A @ 30VDC | Pin plunger | SPDT | 150g | Unsealed | 110 Quick Connect | 200,000 ops |
| SS-01-E | 0.1A @ 125VAC/0.1A @ 30VDC | Pin plunger | SPDT | 25g | Unsealed | Solder | 200,000 ops |
| SS-01-ED | 0.1A @ 125VAC/0.1A @ 30VDC | Pin plunger | SPDT | 25g | Unsealed | Through-Hole PCB - Straight | 200,000 ops |
| SS-01-ET | 0.1A @ 125VAC/0.1A @ 30VDC | Pin plunger | SPDT | 25g | Unsealed | 110 Quick Connect | 200,000 ops |
| SS-01-F | 0.1A @ 125VAC/0.1A @ 30VDC | Pin plunger | SPDT | 50g | Unsealed | Solder | 200,000 ops |
| SS-01-FD | 0.1A @ 125VAC/0.1A @ 30VDC | Pin plunger | SPDT | 50g | Unsealed | Through-Hole PCB - Straight | 200,000 ops |

| | | | | | | | |
|------------------|------------------------|--------------------|------|-----|----------|-----------------------------------|-------------|
| 5GL2D | 125VAC/4A @ 30VDC | roller lever | | | | Hole PCB - Straight | ops |
| SS-5GL2D1 | 5A @ 125VAC/4A @ 30VDC | Hinge roller lever | SPDT | 50g | Unsealed | Through-Hole PCB - parallel left | 200,000 ops |
| SS-5GL2D2 | 5A @ 125VAC/4A @ 30VDC | Hinge roller lever | SPDT | 50g | Unsealed | Through-Hole PCB - parallel right | 200,000 ops |
| SS-5GL2T | 5A @ 125VAC/4A @ 30VDC | Hinge roller lever | SPDT | 50g | Unsealed | 110 Quick Connect | 200,000 ops |

| Part | Rated Resistive Load - Switch | Actuator types | Contact form | Operating Force | Seal type | Termination Style | Service Life - Electrical (Min. @ Rated Loads) |
|--------------------|-------------------------------|------------------------|--------------|-----------------|-----------|-----------------------------------|--|
| SS-5GL2-F | 5A @ 125VAC/4A @ 30VDC | Hinge roller lever | SPDT | 16g | Unsealed | Solder | 200,000 ops |
| SS-5GL2-FD | 5A @ 125VAC/4A @ 30VDC | Hinge roller lever | SPDT | 16g | Unsealed | Through-Hole PCB - Straight | 200,000 ops |
| SS-5GL2-FD1 | 5A @ 125VAC/4A @ 30VDC | Hinge roller lever | SPDT | 16g | Unsealed | Through-Hole PCB - parallel left | 200,000 ops |
| SS-5GL2-FD2 | 5A @ 125VAC/4A @ 30VDC | Hinge roller lever | SPDT | 16g | Unsealed | Through-Hole PCB - parallel right | 200,000 ops |
| SS-5GL2-FT | 5A @ 125VAC/4A @ 30VDC | Hinge roller lever | SPDT | 16g | Unsealed | 110 Quick Connect | 200,000 ops |
| SS-10 | 10.1A @ 125/250VAC | Pin plunger | SPDT | 150g | Unsealed | Solder | 50,000 ops |
| SS-10D | 10.1A @ 125/250VAC | Pin plunger | SPDT | 150g | Unsealed | Through-Hole PCB - Straight | 50,000 ops |
| SS-10T | 10.1A @ 125/250VAC | Pin plunger | SPDT | 150g | Unsealed | 110 Quick Connect | 50,000 ops |
| SS-10GL | 10.1A @ 125/250VAC | Hinge lever | SPDT | 50g | Unsealed | Solder | 50,000 ops |
| SS-10GLD | 10.1A @ 125/250VAC | Hinge lever | SPDT | 50g | Unsealed | Through-Hole PCB - Straight | 50,000 ops |
| SS-10GLT | 10.1A @ 125/250VAC | Hinge lever | SPDT | 50g | Unsealed | 110 Quick Connect | 50,000 ops |
| SS-10GL13 | 10.1A @ 125/250VAC | Simulated roller lever | SPDT | 50g | Unsealed | Solder | 50,000 ops |
| SS- | 10.1A @ | Simulated | SPDT | 50g | Unsealed | Through- | 50,000 |

Snap Action Switch SS

Subminiature Snap Action Switch



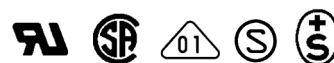

- Economical, subminiature snap action switch offers long service life (30 million operations minimum)
- All models are free from overtravel restrictions, permit easy setting
- Wide switching capacity range from microvoltage/current loads (1 mA at 5 VDC to high-capacity loads 10.1 A at 250 VAC)
- Standard operating force, low force or super-low force models available
- RoHS Compliant



Ordering Information

■ Standard Type

Microvoltage/microcurrent load 0.1 A max. (Bifurcated crossbar contacts)

| Actuator | Contact OF | Model | | | | |
|--|------------|-------------------|------------------|-------------------|-------------------|---------------------|
| | | PCB terminal | | | Soldered terminal | Tab (#110) terminal |
| | | Straight vertical | Parallel to left | Parallel to right | | |
| Pin plunger  | 25 g | SS-01-ED | — | — | SS-01-E | SS-01-ET |
| | 50 g | SS-01-FD | — | — | SS-01-F | SS-01-FT |
| | 150 g | SS-01D | SS-01D1 | SS-01D2 | SS-01 | SS-01T |
| Hinge lever  | 8 g | SS-01GL-ED | — | — | SS-01GL-E | SS-01GL-ET |
| | 16 g | SS-01GL-FD | — | — | SS-01GL-F | SS-01GL-FT |
| | 50 g | SS-01GLD | SS-01GLD1 | SS-01GLD2 | SS-01GL | SS-01GLT |
| Simulated roller lever  | 8 g | SS-01GL13-ED | — | — | SS-01GL13-E | SS-01GL13-ET |
| | 16 g | SS-01GL13-FD | — | — | SS-01GL13-F | SS-01GL13-FT |
| | 50 g | SS-01GL13D | — | — | SS-01GL13 | SS-01GL13T |
| Formed hinge lever  | 8 g | — | — | — | SS-01GL14-E | SS-01GL14-ET |
| | 16 g | SS-01GL14-FD | — | — | SS-01GL14-F | — |
| | 50 g | SS-01GL14D | — | — | SS-01GL14 | SS-01GL14T |
| Hinged roller lever  | 8 g | SS-01GL2-ED | — | — | SS-01GL2-E | SS-01GL2-ET |
| | 16 g | SS-01GL2-FD | — | — | SS-01GL2-F | SS-01GL2-FT |
| | 50 g | SS-01GL2D | — | — | SS-01GL2 | SS-01GL2T |

■ General-Purpose

5 A max. (Standard rivet contacts)

| Actuator | Contact OF | Model | | | | |
|------------------------|------------|-------------------|------------------|-------------------|-------------------|---------------------|
| | | PCB terminal | | | Soldered terminal | Tab (#110) terminal |
| | | Straight vertical | Parallel to left | Parallel to right | | |
| Pin plunger | 50 g | SS-5-FD | SS-5-FD1 | SS-5-FD2 | SS-5-F | SS-5-FT |
| | 150 g | SS-5D | SS-5D1 | SS-5D2 | SS-5 | SS-5T |
| Hinge lever | 16 g | SS-5GL-FD | SS-5GL-FD1 | SS-5GL-FD2 | SS-5GL-F | SS-5GL-FT |
| | 50 g | SS-5GLD | SS-5GLD1 | SS-5GLD2 | SS-5GL | SS-5GLT |
| Simulated roller lever | 16 g | SS-5GL13-FD | — | SS-5GL13-FD2 | SS-5GL13-F | SS-5GL13-FT |
| | 50 g | SS-5GL13D | SS-5GL13D1 | SS-5GL13D2 | SS-5GL13 | SS-5GL13T |
| Formed hinge lever | 16 g | SS-5GL14-FD | SS-5GL14-FD1 | — | SS-5GL14-F | SS-5GL14-FT |
| | 50 g | SS-5GL14D | SS-5GL14D1 | SS-5GL14D2 | SS-5GL14 | SS-5GL14T |
| Hinge roller lever | 16 g | SS-5GL2-FD | SS-5GL2-FD1 | SS-5GL2-FD2 | SS-5GL2-F | SS-5GL2-FT |
| | 50 g | SS-5GL2D | SS-5GL2D1 | SS-5GL2D2 | SS-5GL2 | SS-5GL2T |

10.1 A max. (Standard rivet contacts)

| Actuator | Contact OF | Model | | | | |
|------------------------|------------|-------------------|------------------|-------------------|-------------------|---------------------|
| | | PCB terminal | | | Soldered terminal | Tab (#110) terminal |
| | | Straight vertical | Parallel to left | Parallel to right | | |
| Pin plunger | 150 g | SS-10D | — | — | SS-10 | SS-10T |
| Hinge lever | 50 g | SS-10GLD | — | — | SS-10GL | SS-10GLT |
| Simulated roller lever | 50 g | SS-10GL13D | — | — | SS-10GL13 | SS-10GL13T |
| Formed hinge lever | 50 g | — | — | — | SS-10GL14 | — |
| Hinge roller lever | 50 g | SS-10GL2D | — | — | SS-10GL2 | SS-10GL2T |

Specifications

■ Characteristics

| | | | |
|-------------------------------------|--|---|---|
| Switch type | General-purpose | | |
| Operating speed (see note 3) | 0.1 mm to 1 m/second (0.004 to 39.4 in/second) | | |
| Operating frequency | Mechanical | 400 operations per minute (pin plunger actuator type) | |
| | Electrical | 60 operations per minute (pin plunger actuator type) | |
| Insulation resistance | 100 MΩ at 500 VDC | | |
| Dielectric strength | Crossbar contact type | 600 VAC, 50/60 Hz for 1 minute (see note 1) | |
| | Others | 1,000 VAC, 50/60 Hz for 1 minute between terminals of same polarity 1,500 VAC, 50/60 Hz for 1 minute between current-carrying parts and ground and between each terminal and noncurrent-carrying metal parts | |
| Vibration | Malfunction durability | 10 to 55 Hz, 1.5 mm double amplitude | |
| Shock | Mechanical durability | Low-OF type: 500 m/s ² min. (approx. 50 g) Others: 1,000 m/s ² min. (approx. 100 g) | |
| | | Malfunction durability | Standard type: 300 m/s ² min. (approx. 30 g) Low-OF type: 200 m/s ² min. (approx. 20 g) Lever type at TTP: Contact gap, 1 ms max. |
| | Ambient temperature | | Operating |
| | Humidity | 85% RH max. | |
| Service life | Mechanical | 30 million operations minimum (OT: rated value) (see note 4) | |
| | Electrical | 200,000 operations minimum (rated load) (see note 2) | |
| Weight | Approx. 1.6 g pin plunger type | | |

- Note:**
1. SS-10 series only.
 2. 50,000 operations minimum for the SS-10 series.
 3. Applies to the pin plunger type (at the pin plunger of the lever type).
 4. 10 million operations for the SS-10 series.
 5. Data shown are of initial value.

■ Operating Characteristics

| Characteristics | Part number | | | | |
|-----------------|------------------------------------|------------------------------------|------------------------------------|------------------------------------|------------------------------------|
| | SS-01-E | SS-01-F SS-5-F | SS-01 SS-5 | SS-10 | SS-01GL-E |
| OF max. | 25 g | 50 g | 150 g | 150 g | 8 g |
| RF min. | 2 g | 4 g | 25 g | 25 g | 1 g |
| PT max. | 0.5 mm (0.020 in) | 0.5 mm (0.020 in) | 0.5 mm (0.020 in) | 0.6 mm (0.024 in) | 1.2 mm (0.047 in) |
| OT min. | 0.5 mm (0.020 in) | 0.5 mm (0.020 in) | 0.5 mm (0.020 in) | 0.4 mm (0.016 in) | 0.8 mm (0.032 in) |
| MD max. | 0.1 mm (0.004 in) | 0.1 mm (0.004 in) | 0.1 mm (0.004 in) | 0.12 mm (0.005 in) | 13.6 mm (0.535 in) |
| OP | 8.4 ± 0.5 mm (0.331 ± 0.020 in) | 8.4 ± 0.5 mm (0.331 ± 0.020 in) | 8.4 ± 0.5 mm (0.331 ± 0.020 in) | 8.4 ± 0.5 mm (0.331 ± 0.020 in) | 8.8 ± 0.8 mm (0.346 ± 0.032 in) |

| Characteristics | Part number | | | | |
|-----------------|--------------------------------|--------------------------------|--------------------------------|---------------------------------|---------------------------------|
| | SS-01GL-F SS-5GL-F | SS-01GL SS-5GL | SS-10GL | SS-10GL13-E | SS-10GL13-F SS-5GL13-F |
| OF max. | 16 g | 50 g | 50 g | 8 g | 16 g |
| RF min. | 2 g | 6 g | 6 g | 1 g | 2 g |
| PT max. | 1.2 mm (0.047 in) | 1.2 mm (0.047 in) | 1.0 mm (0.039 in) | 1.2 mm (0.047 in) | 1.2 mm (0.047 in) |
| OT min. | 0.8 mm (0.032 in) | 0.8 mm (0.032 in) | 1.0 mm (0.039 in) | 0.8 mm (0.032 in) | 0.8 mm (0.032 in) |
| MD max. | 13.6 mm (0.535 in) | 13.6 mm (0.535 in) | 13.6 mm (0.535 in) | 15.5 mm (0.610 in) | 15.5 mm (0.610 in) |
| OP | 8.8±0.8 mm (0.346±0.032 in) | 8.8±0.8 mm (0.346±0.032 in) | 8.8±0.8 mm (0.346±0.032 in) | 10.7±0.8 mm (0.421±0.032 in) | 10.7±0.8 mm (0.421±0.032 in) |

| Characteristics | Part number | | | | |
|-----------------|-------------------------------------|-------------------------------------|-------------------------------------|-------------------------------------|-------------------------------------|
| | SS-01GL13 SS-5GL13 | SS-10GL13 | SS-01GL14-E | SS-01GL14-F SS-5GL14-F | SS-01GL14 SS-5GL14 |
| OF max. | 50 g | 50 g | 8 g | 16 g | 50 g |
| RF min. | 6 g | 6 g | 1 g | 2 g | 6 g |
| PT max. | 1.2 mm (0.047 in) | 1.0 mm (0.039 in) | 1.2 mm (0.047 in) | 1.2 mm (0.047 in) | 1.2 mm (0.047 in) |
| OT min. | 0.8 mm (0.032 in) | 1.0 mm (0.039 in) | 0.8 mm (0.032 in) | 0.8 mm (0.032 in) | 0.8 mm (0.032 in) |
| MD max. | 15.5 mm (0.610 in) | 15.5 mm (0.610 in) | 14.9 mm (0.587 in) | 14.9 mm (0.587 in) | 14.9 mm (0.587 in) |
| OP | 10.7 ± 0.8 mm (0.421 ± 0.032 in) | 10.7 ± 0.8 mm (0.421 ± 0.032 in) | 10.1 ± 0.8 mm (0.398 ± 0.032 in) | 10.1 ± 0.8 mm (0.398 ± 0.032 in) | 10.1 ± 0.8 mm (0.398 ± 0.032 in) |

| Characteristics | Part number | | | | |
|-----------------|-------------------------------------|-------------------------------------|-------------------------------------|-------------------------------------|-------------------------------------|
| | SS-10GL14 | SS-01GL2-E | SS-01GL2-F SS-5GL2-F | SS-01GL2 SS-5GL2 | SS-10GL2 |
| OF max. | 50 g | 8 g | 16 g | 50 g | 50 g |
| RF min. | 6 g | 1 g | 2 g | 6 g | 6 g |
| PT max. | 1.0 mm (0.039 in) | 1.2 mm (0.047 in) | 1.2 mm (0.047 in) | 1.2 mm (0.047 in) | 1.0 mm (0.039 in) |
| OT min. | 1.0 mm (0.039 in) | 0.8 mm (0.032 in) | 0.8 mm (0.032 in) | 0.8 mm (0.032 in) | 1.0 mm (0.039 in) |
| MD max. | 14.9 mm (0.587 in) | 19.3 mm (0.760 in) | 19.3 mm (0.760 in) | 19.3 mm (0.760 in) | 19.3 mm (0.760 in) |
| OP | 10.1 ± 0.8 mm (0.398 ± 0.032 in) | 14.5 ± 0.8 mm (0.571 ± 0.032 in) | 14.5 ± 0.8 mm (0.571 ± 0.032 in) | 14.5 ± 0.8 mm (0.571 ± 0.032 in) | 14.5 ± 0.8 mm (0.571 ± 0.032 in) |

■ Ratings

Microvoltage/microcurrent load type

| Contact form | General purpose/resistive load | |
|----------------|--------------------------------|----------|
| | Bifurcated crossbar contacts | |
| | NC | NO |
| 125 VAC | 0.1 A | 0.1 A |
| 30 VDC | 0.1 A | 0.1 A |
| Inrush current | 1 A max. | 1 A max. |

Standard type general purpose

| Switch series: | Rivet contacts | | | | | | | | | |
|----------------|--|-------|--------|--------|----------------|--------|----------------|-------|----------------|--------|
| | Resistive load | | | | Lamp load | | Inductive load | | Motor load | |
| | SS-5 | | SS-10 | | SS-5 and SS-10 | | SS-5 and SS-10 | | SS-5 and SS-10 | |
| Contact form | NC | NO | NC | NO | NC | NO | NC | NO | NC | NO |
| 125 VAC | 5 A | 5 A | 10.1 A | 10.1 A | 1.5 A | 0.7 A | 3 A | 3 A | 2.5 A | 1.3 A |
| 250 VAC | 3 A | 3 A | 10.1 A | 10.1 A | 1 A | 0.5 A | 2 A | 2 A | 1.5 A | 0.8 A |
| 8 VDC | 5 A | 5 A | 10.1 A | 10.1 A | 2 A | 2 A | 5 A | 4 A | 3 A | 3 A |
| 14 VDC | 5 A | 5 A | 10.1 A | 10.1 A | 2 A | 2 A | 4 A | 4 A | 3 A | 3 A |
| 30 VDC | 4 A | 4 A | 4 A | 4 A | 2 A | 2 A | 3 A | 3 A | 3 A | 3 A |
| 125 VDC | 0.4 A | 0.4 A | 0.4 A | 0.4 A | 0.05 A | 0.05 A | 0.4 A | 0.4 A | 0.05 A | 0.05 A |
| 250 VDC | 0.2 A | 0.2 A | 0.2 A | 0.2 A | 0.03 A | 0.03 A | 0.2 A | 0.2 A | 0.03 A | 0.03 A |
| Inrush current | 20 A max. 10 A max. 20 A max. 15 A max. (both non-inductive and inductive loads) | | | | | | | | | |

- Note:**
- The above current ratings are the values of the steady-state current.
 - Inductive load has a power factor of 0.4 min. (AC) and a time constant of 7 milliseconds max. (DC). The inductive load applicable to the SS-10 series must have a power factor of 0.75 min.
 - Lamp load has an inrush current of 10 times the steady-state current
 - Motor load has an inrush current of 6 times the steady-state current.
 - If the switch is used in a DC circuit and is subjected to inrush current or surge, connect a surge suppressor across the switch.

Contact Resistance (mΩ max., initial)

| | SS-01□ | SS-5□ | SS-10□ |
|---|--------|------------|--------|
| Contact rating: | 0.1 A | 3 A or 5 A | 10.1 A |
| Normal operating force models (SS-□) | 50 mΩ | 30 mΩ | 30 mΩ |
| Low operating force models (SS-□-F) | 100 mΩ | 50 mΩ | — |
| Super-low operating force models (SS-□-E) | 150 mΩ | — | — |
| Lead wire models (all OF types) | 100 mΩ | 50 mΩ | — |

Contact Form

SPDT
(common throughout the series)

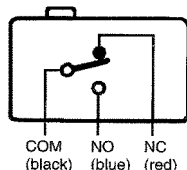

SPST-NC*
(standard models rated at 0.1 to 0.5 A)

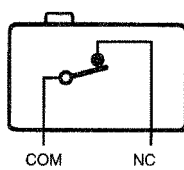

SPST-NO*
(standard models rated at 0.1 to 5 A)

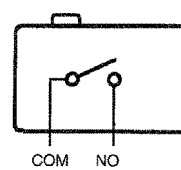

Sealed lead wire terminal models have color coded leads.

* Consult Omron for SPST-NC and SPST-NO contact form types ordering information.

Approvals

UL (File No. E41515), CSA (File No. LR21642), SS-5/SS-10: EN conforms 61058-1

| Type | | Rating |
|--------------|----------------------|-------------------------|
| SS-10 series | General-purpose type | 10.1 A, 250 VAC |
| SS-5 series | General-purpose type | 5 A, 125 V, 3 A 250 VAC |
| SS-01 series | Super-low force type | 0.1 A, 125 VAC, 30 VDC |

VDE (File No. 5861-3221)

| Type | | Rating |
|-------------|----------------------|--------------|
| SS-5 series | General-purpose type | 5 A, 250 VAC |

SEMKO (File Nos. 43-8614026/43-891609)

| Type | | Rating |
|--------------|----------------------|---------------|
| SS-10 series | General-purpose type | 10 A, 250 VAC |
| SS-5 series | General-purpose type | 5 A, 250 VAC |

Note: The rated values approved by each of the safety standards (e.g. UL, CSA) may be different from the performance characteristics individually defined in this catalog.

Engineering Data

Mechanical service life

Standard type (SS-5, SS-10 series)

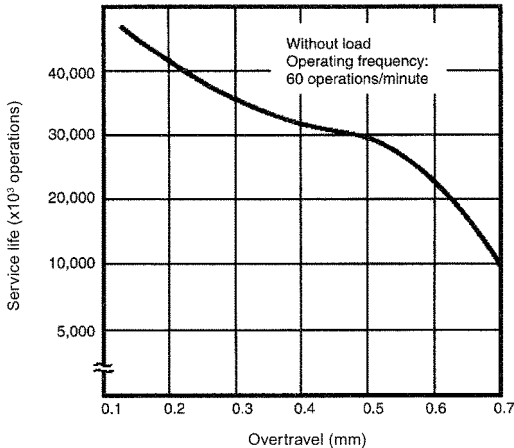

Electrical service life

Standard type (SS-5 series)

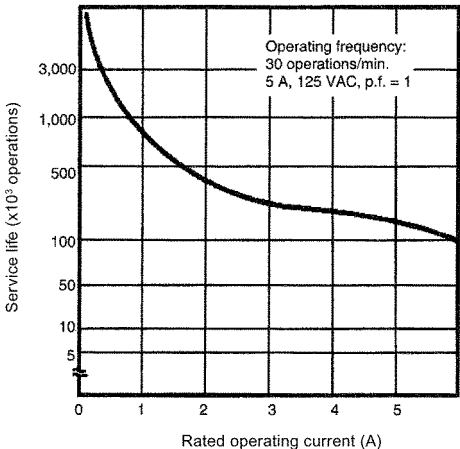

Dimensions

Unit: mm (inch)

Pin Plunger

- SS-01 (-E, -F)
- SS-5 (-F)
- SS-10

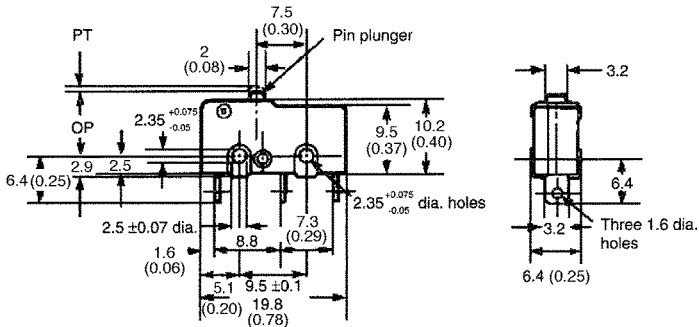

Hinge Lever

- SS-01GL (-E, -F)
- SS-5GL (-F)
- SS-10GL

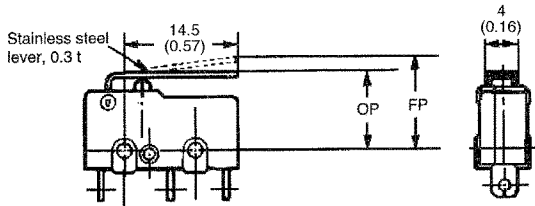

■ Simulated Roller Lever

SS-01GL13 (-E, -F)
 SS-5GL13 (-F)
 SS-10GL13

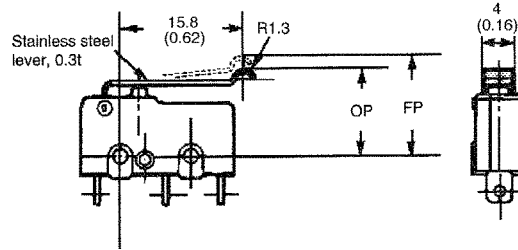

■ Formed Hinge Lever

SS-01GL14 (-E, -F)
 SS-5GL14 (-F)
 SS-10GL14

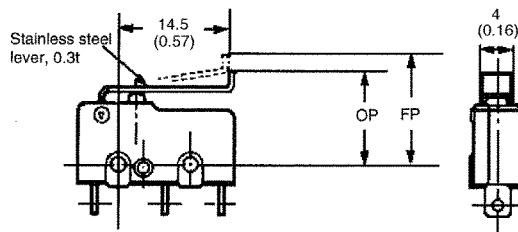

Note: 1. Unless otherwise specified, a tolerance of ± 0.4 mm applies to all dimensions.

2. Straight vertical PCB terminal models are shown above. Soldered terminal, Tab (#110) terminal, lead wire terminal, PCB terminal parallel to left and PCB terminal parallel to right are shown in the Terminals section.

■ Hinge Roller Lever

SS-01GL2 (-E, -F)
 SS-5GL2 (-F)
 SS-10GL2

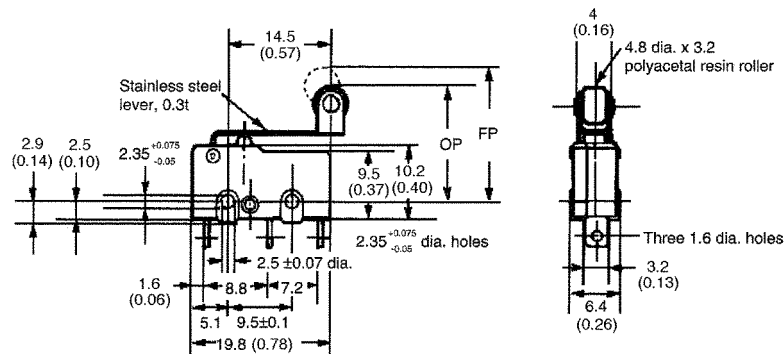

Note: Unless otherwise specified, a tolerance of ± 0.4 mm applies to all dimensions.

■ Mounting holes

Standard types

Mounting holes below are for reference only

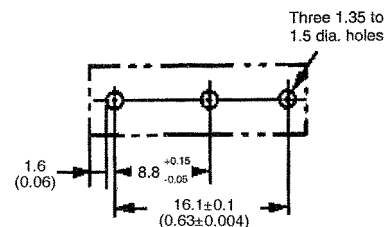
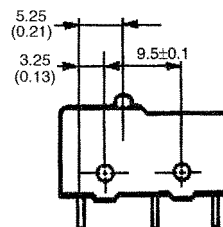
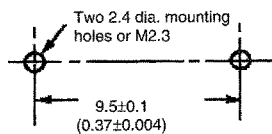

Note: Unless otherwise specified, a tolerance of ± 0.4 mm applies to all dimensions.

Unit: mm (inch)

■ Terminals

General-Purpose Type

PCB terminal, straight vertical (D)

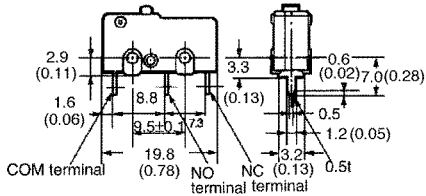

PCB terminal, parallel to left (D1)

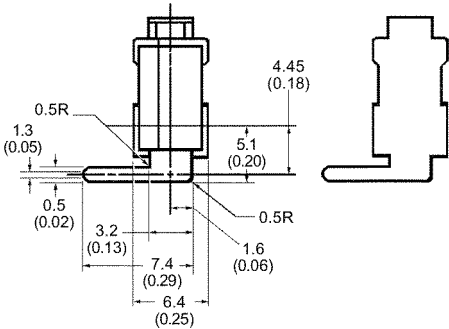

PCB terminal, parallel to right (D2)

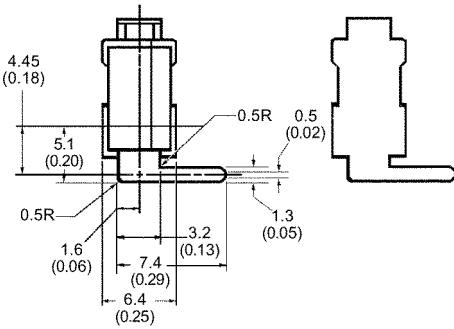

Note: Thickness of all the terminals is 0.5 mm.

Soldered terminal (blank)

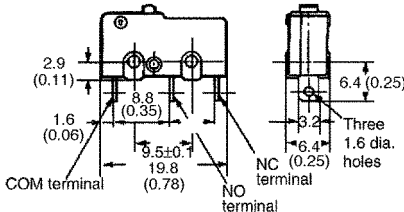

Quick-connect tab (#110) terminal (T)

