

7 CIRCUIT DARLINGTON TRANSISTOR ARRAY

FEATURES

- Output Current : 500mA Max.
- High Sustaining Voltage Outputs : 50V Min.
- Output Clamp Diodes.
- Inputs Compatible With Various Types of Logic.
- PKG Type AP : DIP-16Pin, DIP-16Pin(1) AF : FLP-16Pin

TYPE	INPUT RESISTOR	DESIGNATION
KID65001AP/AF	No (External)	General Purpose
KID65002AP/AF	Zener Diode 7V+10.5k	14 25V P-MOS
KID65003AP/AF	2.7k	TTL, 5V C-MOS
KID65004AP/AF	10.5k	6 15V P-MOS, C-MOS

DESCRIPTION:

The KID65001AP/AF Series are high-voltage, high-current darlington transistor array comprised of seven NPN darlington pairs. All units feature internal clamp diodes for switching inductive loads.

MAXIMUM RATINGS (Ta=25 , unless otherwise noted)

CHARACTERISTIC		SYMBOL	RATING	UNIT
Output Sustaining Voltage		$V_{CE(SUS)}$	50	V
Output Current		I_{OUT}	500	mA/ch
Input Voltage		$I_{IN}^{1)}$	-0.5 +30	V
Input Current		$I_{IN}^{2)}$	25	mA
Clamp Diode	Reverse Voltage	V_R	50	V
	Forward Current	I_F	500	mA
GND Terminal Current		I_{GND}	2.8	A
Power Dissipation	AP	P_D	1.47	W
	AF		0.54 / 0.63 ³⁾ / 1.25 ⁴⁾	W
Operating Temperature		T_{opr}	-40 85	
Storage Temperature		T_{stg}	-55 150	

1) Except KID65001AP/AF

2) Only KID65001AP/AF

3) On PCB(30 × 30 × 1.6mm, Cu 50%)

4) On PCB (Test Board : JEDEC 2s2p)

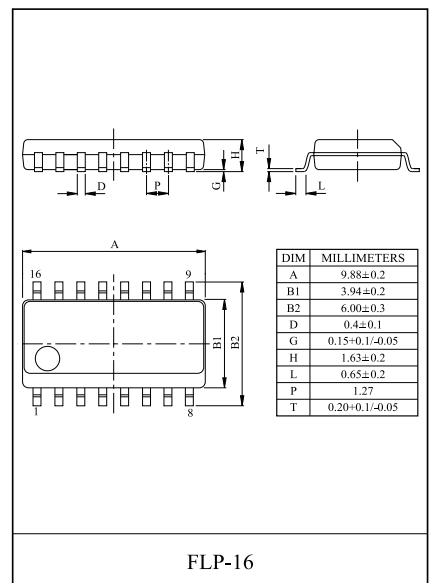
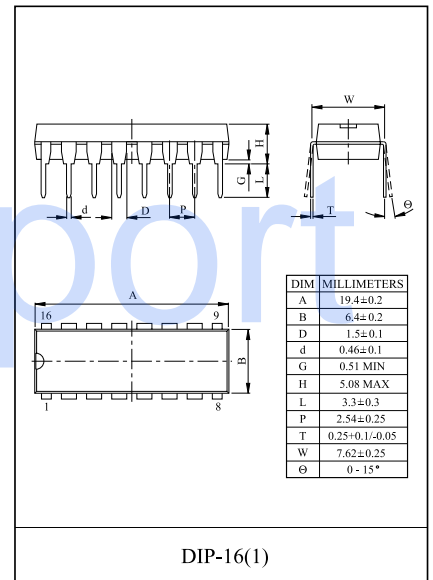
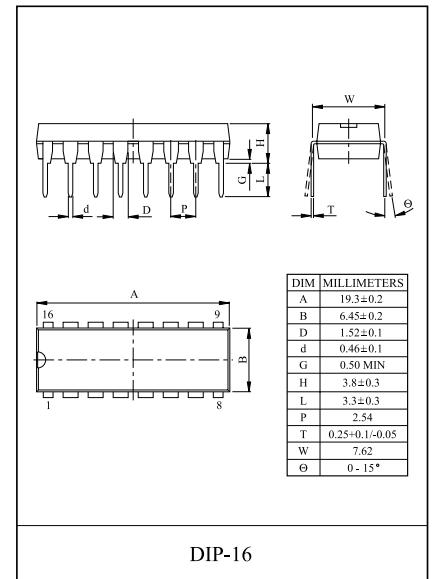

KID65001AP/AF~KID65004AP/AF

PIN CONNECTION (TOP VIEW)

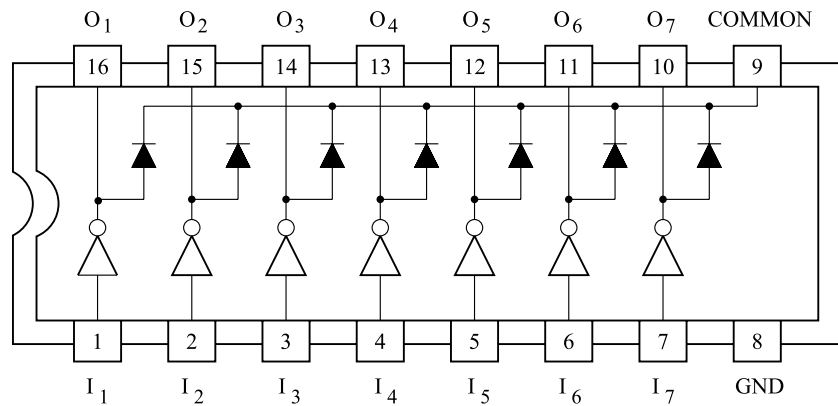

SCHEMATICS (EACH DRIVER)

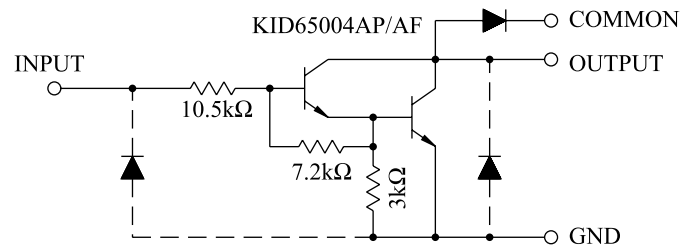
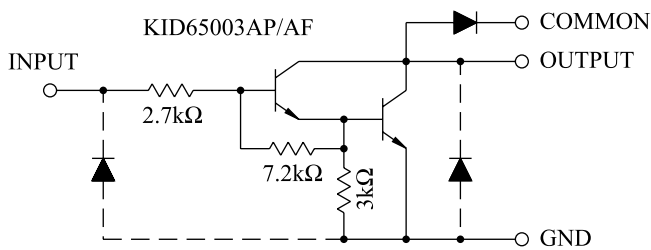
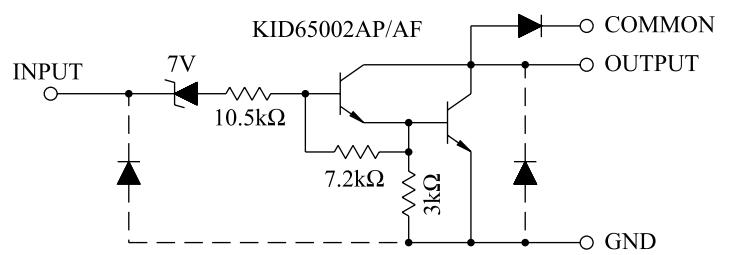
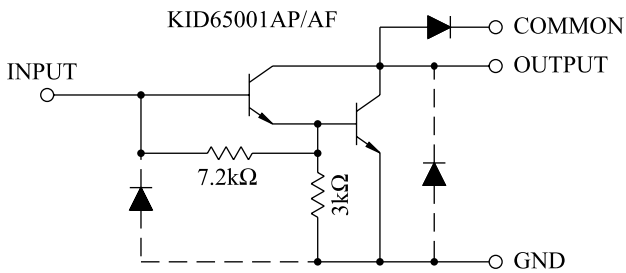

KID65001AP/AF~KID65004AP/AF

RECOMMENDED OPERATING CONDITIONS (Ta=-40 ~ 85 °C)

CHARACTERISTIC	SYMBOL	CONDITION	MIN.	TYP.	MAX.	UNIT	
Output Sustaining Voltage	$V_{CE(SUS)}$		0	-	50	V	
Output Current	I_{OUT} (AP, Ta=85 °C)	T _{PW} =25ms, DF=10%, 7 Circuits	0	-	370	mA	
		T _{PW} =25ms, DF=30%, 7 Circuits	0	-	200		
	I_{OUT} (AF, Ta=85 °C)	T _{PW} =25ms, DF=10%, 7 Circuits	-	-	290	mA	
		T _{PW} =25ms, DF=30%, 7 Circuits	-	-	150		
Input Voltage	V_{IN}	Except KID65001AP/AF	0	-	30	V	
Input Current	I_{IN}	Only KID65001AP/AF	0	-	5	mA	
Clamp Diode Reverse Voltage	V_R		-	-	50	V	
Clamp Diode Forward Current	I_F		-	-	400	mA	
Power Dissipation	AP	P_D	Ta=85	-	-	0.76	W
	AF		Ta=85	0.28 / 0.32* / 0.65**			

* On PCB (30 × 30 × 1.6mm, Cu 50%)

** On PCB (Test Board : JEDEC 2s2p)

ELECTRICAL CHARACTERISTICS (Ta=25 °C, unless otherwise noted)

CHARACTERISTICS	SYMBOL	TEST CIRCUIT	TEST CONDITION	MIN.	TYP.	MAX.	UNIT
Output Leak Current	I_{CEX}	1	$V_{CE}=50V, Ta=25$	-	-	50	μA
			$V_{CE}=50V, Ta=85$	-	-	100	
			$V_{CE}=50V, V_{IN}=6V$	-	-	500	
			$V_{CE}=50V, V_{IN}=1V$	-	-	500	
Collector-Emitter Saturation Voltage	$V_{CE(sat)}$	2	$I_{OUT}=350mA, I_{IN}=500 \mu A$	-	1.3	1.6	V
			$I_{OUT}=200mA, I_{IN}=350 \mu A$	-	1.1	1.3	
			$I_{OUT}=100mA, I_{IN}=250 \mu A$	-	0.9	1.1	
Input Current	$I_{IN(ON)}$	3	$V_{IN}=17V$	-	0.82	1.25	mA
			$V_{IN}=3.85V$	-	0.93	1.35	
			$V_{IN}=5V$	-	0.35	0.5	
			$V_{IN}=12V$	-	1.0	1.45	
	$I_{IN(OFF)}$	4	$I_{OUT}=500 \mu A, Ta=85$	50	65	-	μA
Input Voltage	$V_{IN(ON)}$	5	$V_{CE}=2V, I_{OUT}=300mA$	-	-	13	V
			$V_{CE}=2V, I_{OUT}=200mA$	-	-	2.4	
			$V_{CE}=2V, I_{OUT}=250mA$	-	-	2.7	
			$V_{CE}=2V, I_{OUT}=300mA$	-	-	3.0	
			$V_{CE}=2V, I_{OUT}=125mA$	-	-	5.0	
			$V_{CE}=2V, I_{OUT}=200mA$	-	-	6.0	
			$V_{CE}=2V, I_{OUT}=275mA$	-	-	7.0	
	$V_{CE}=2V, I_{OUT}=350mA$	-	-	8.0			
		$V_{IN(OFF)}$		-	0	-	7.4
				0	-	0.7	
	0			-	1.0		
DC Current Transfer Ratio	h_{FE}	2	$V_{CE}=2V, I_{OUT}=350mA$	1000	-	-	
Clamp Diode Reverse Current	I_R	6	$V_R=50V, Ta=25$	-	-	50	μA
			$V_R=50V, Ta=85$	-	-	100	
Clamp Diode Forward Voltage	V_F	7	$I_F=350mA$	-	-	2.0	V
Input Capacitance	C_{IN}			-	15	-	pF
Turn-ON Delay	t_{ON}	8	$V_{OUT}=50V, R_L=163$	-	0.1	-	μs
Turn-OFF Delay	t_{OFF}			-	0.2	-	

KID65001AP/AF~KID65004AP/AF

TEST CIRCUIT

1. I_{CEX}

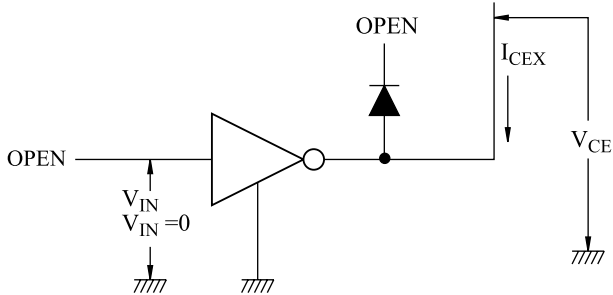

2. $V_{CE(sat)}, h_{FE}$

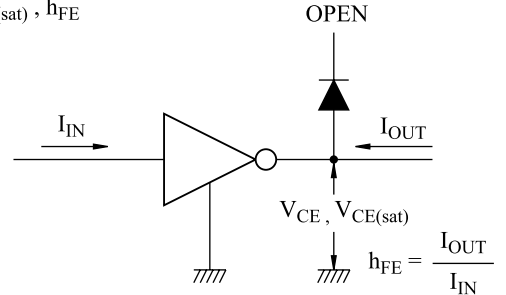

3. $I_{IN(ON)}$

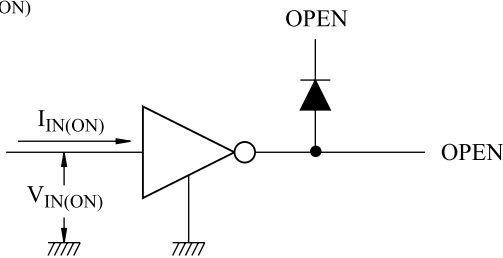

4. $I_{IN(OFF)}$

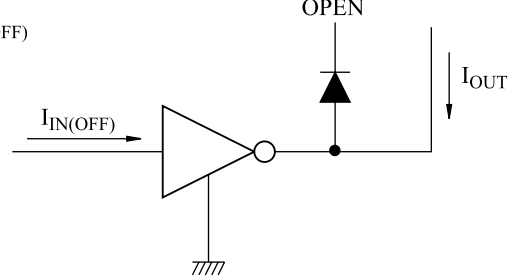

5. $V_{IN(ON)}$

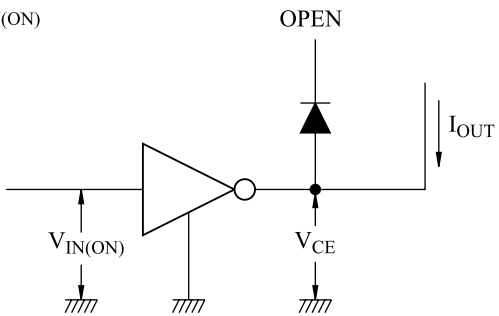

6. I_R

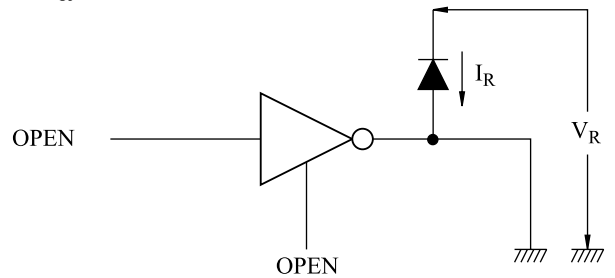

7. V_F

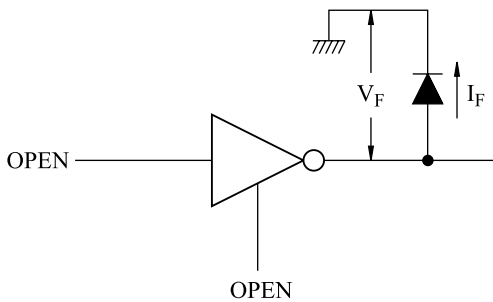

KID65001AP/AF~KID65004AP/AF

8. t_{ON} , t_{OFF}

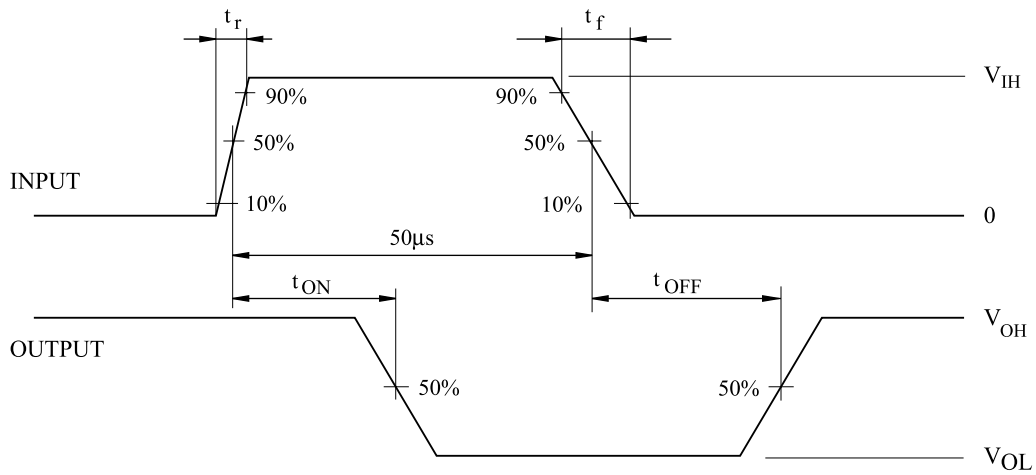
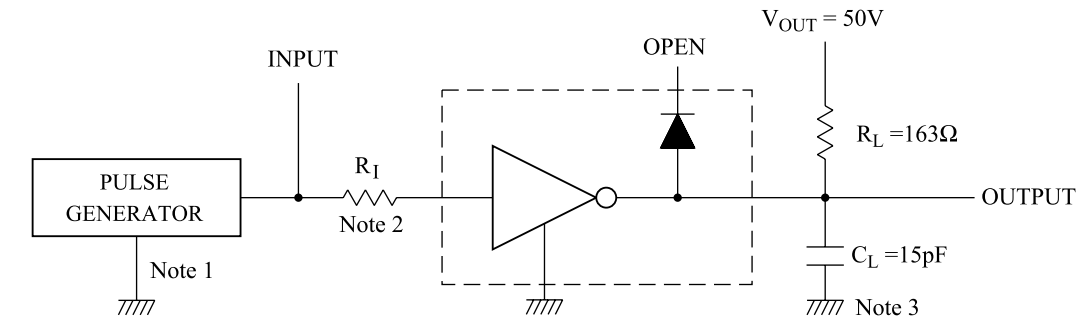

Notes : 1. Pulse Width 50 μ s, Duty Cycle 10%
Output Impedance 50 Ω , t_r 5ns, t_f 10ns

2. See below

Input Conditions

Type Number	R_1	V_{IH}
KID65001AP/AF	2.7k	3V
KID65002AP/AF	0	13V
KID65003AP/AF	0	3V
KID65004AP/AF	0	8V

3. C_L includes probe and Jig capacitance.

KID65001AP/AF~KID65004AP/AF

Fig. 1 I_{OUT} - DUTY CYCLE

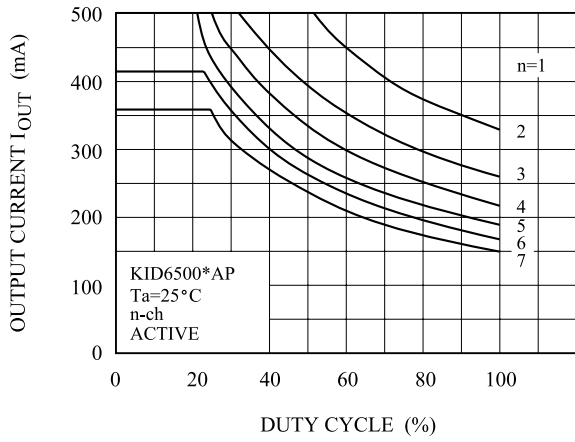

Fig. 2 I_{OUT} - DUTY CYCLE

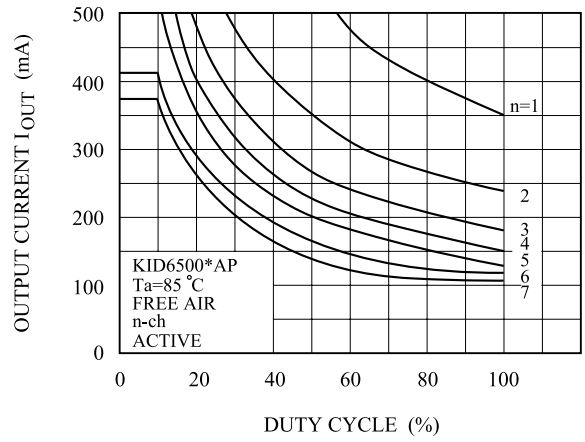

Fig. 3 I_{OUT} - DUTY CYCLE

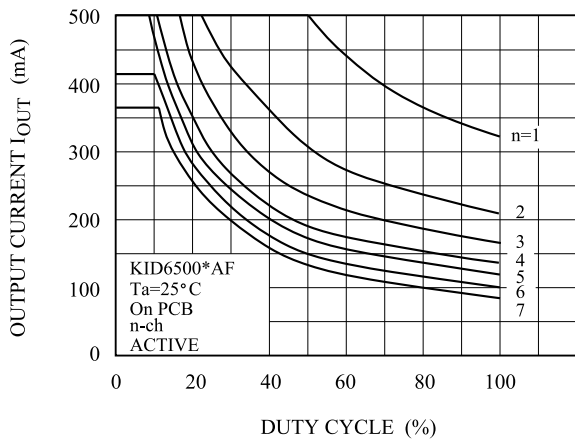

Fig. 4 I_{OUT} - DUTY CYCLE

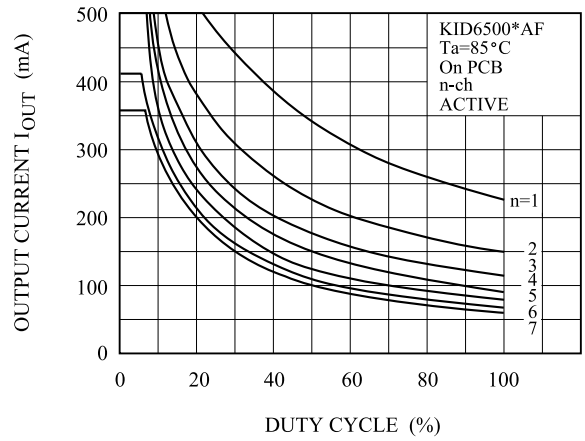

Fig. 5 I_{IN} - V_{IN}

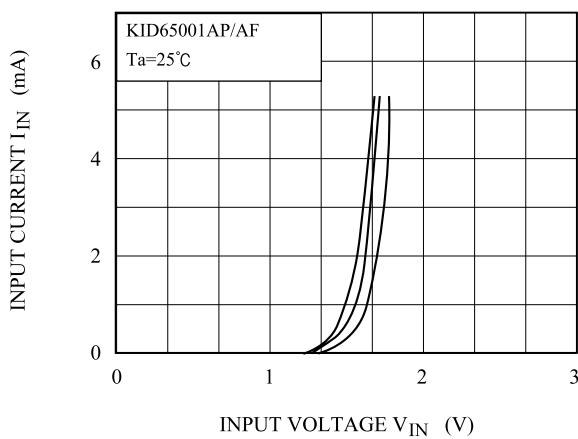
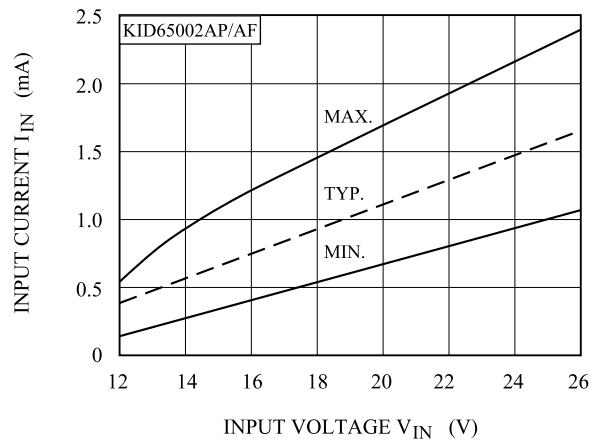

Fig. 6 I_{IN} - V_{IN}



KID65001AP/AF~KID65004AP/AF

Fig. 7 $I_{IN} - V_{IN}$

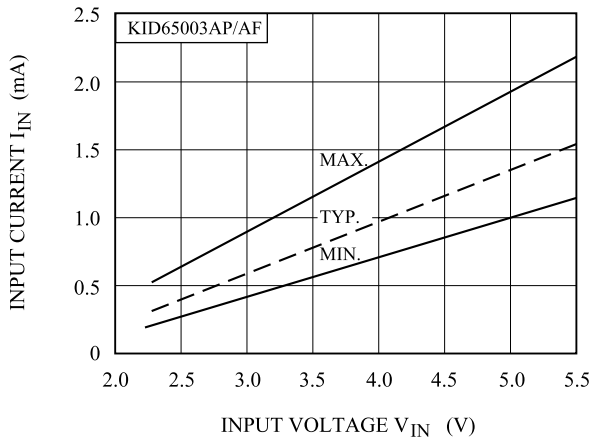

Fig. 8 $I_{IN} - V_{IN}$

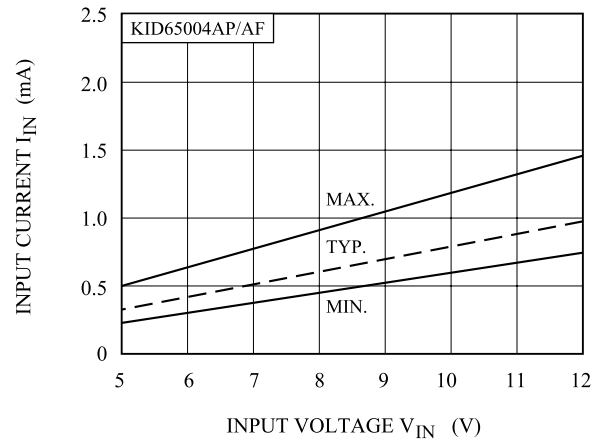

Fig. 9 $I_{OUT} - V_{CE(sat)}$

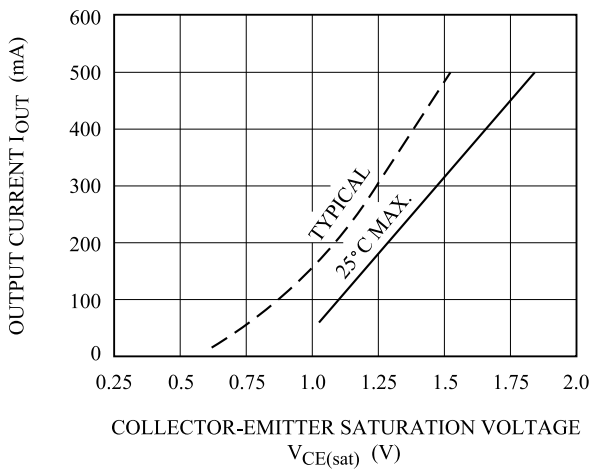

Fig. 10 $h_{FE} - I_{OUT}$

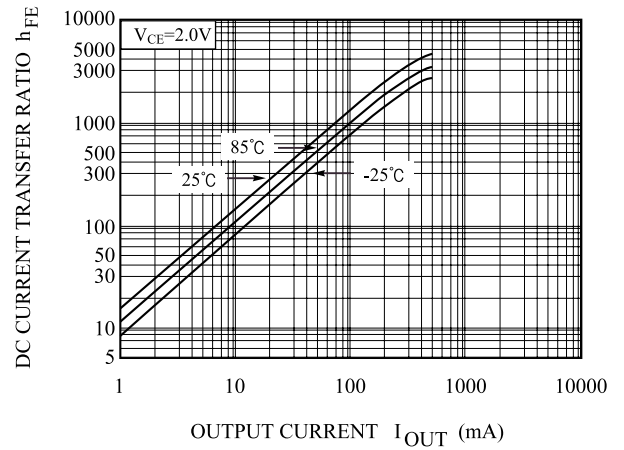

Fig. 11 $I_F - V_F$

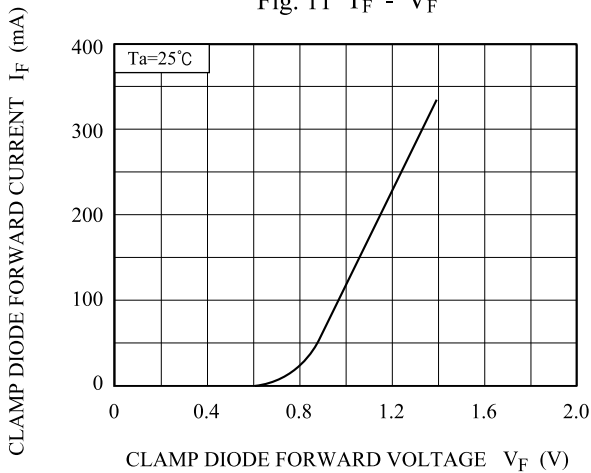

Fig. 12 $P_D - T_a$

