



Is Now Part of



To learn more about ON Semiconductor, please visit our website at  
[www.onsemi.com](http://www.onsemi.com)

ON Semiconductor and the ON Semiconductor logo are trademarks of Semiconductor Components Industries, LLC dba ON Semiconductor or its subsidiaries in the United States and/or other countries. ON Semiconductor owns the rights to a number of patents, trademarks, copyrights, trade secrets, and other intellectual property. A listing of ON Semiconductor's product/patent coverage may be accessed at [www.onsemi.com/site/pdf/Patent-Marking.pdf](http://www.onsemi.com/site/pdf/Patent-Marking.pdf). ON Semiconductor reserves the right to make changes without further notice to any products herein. ON Semiconductor makes no warranty, representation or guarantee regarding the suitability of its products for any particular purpose, nor does ON Semiconductor assume any liability arising out of the application or use of any product or circuit, and specifically disclaims any and all liability, including without limitation special, consequential or incidental damages. Buyer is responsible for its products and applications using ON Semiconductor products, including compliance with all laws, regulations and safety requirements or standards, regardless of any support or applications information provided by ON Semiconductor. "Typical" parameters which may be provided in ON Semiconductor data sheets and/or specifications can and do vary in different applications and actual performance may vary over time. All operating parameters, including "Typicals" must be validated for each customer application by customer's technical experts. ON Semiconductor does not convey any license under its patent rights nor the rights of others. ON Semiconductor products are not designed, intended, or authorized for use as a critical component in life support systems or any FDA Class 3 medical devices or medical devices with a same or similar classification in a foreign jurisdiction or any devices intended for implantation in the human body. Should Buyer purchase or use ON Semiconductor products for any such unintended or unauthorized application, Buyer shall indemnify and hold ON Semiconductor and its officers, employees, subsidiaries, affiliates, and distributors harmless against all claims, costs, damages, and expenses, and reasonable attorney fees arising out of, directly or indirectly, any claim of personal injury or death associated with such unintended or unauthorized use, even if such claim alleges that ON Semiconductor was negligent regarding the design or manufacture of the part. ON Semiconductor is an Equal Opportunity/Affirmative Action Employer. This literature is subject to all applicable copyright laws and is not for resale in any manner.



August 2016



# 2N7000 / 2N7002 / NDS7002A N-Channel Enhancement Mode Field Effect Transistor

## Features

- High Density Cell Design for Low  $R_{DS(ON)}$
- Voltage Controlled Small Signal Switch
- Rugged and Reliable
- High Saturation Current Capability

## Description

These N-channel enhancement mode field effect transistors are produced using Fairchild's proprietary, high cell density, DMOS technology. These products have been designed to minimize on-state resistance while providing rugged, reliable, and fast switching performance. They can be used in most applications requiring up to 400 mA DC and can deliver pulsed currents up to 2 A. These products are particularly suited for low-voltage, low-current applications, such as small servo motor control, power MOSFET gate drivers, and other switching applications.

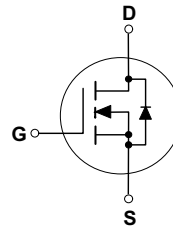
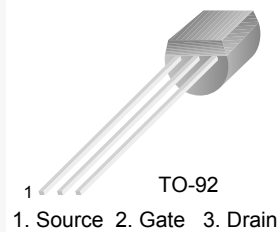

## Ordering Information

Part Number	Marking	Package	Packing Method	Min Order Qty / Immediate Pack Qty
2N7000	2N7000	TO-92 3L	Bulk	10000 / 1000
2N7000_D74Z	2N7000	TO-92 3L	Ammo	2000 / 2000
2N7000_D75Z	2N7000	TO-92 3L	Tape and Reel	2000 / 2000
2N7000_D26Z	2N7000	TO-92 3L	Tape and Reel	2000 / 2000
2N7002	702	SOT-23 3L	Tape and Reel	3000 / 3000
NDS7002A	712	SOT-23 3L	Tape and Reel	3000 / 3000

2N7000 / 2N7002 / NDS7002A — N-Channel Enhancement Mode Field Effect Transistor

## Absolute Maximum Ratings

Stresses exceeding the absolute maximum ratings may damage the device. The device may not function or be operable above the recommended operating conditions and stressing the parts to these levels is not recommended. In addition, extended exposure to stresses above the recommended operating conditions may affect device reliability. The absolute maximum ratings are stress ratings only. Values are at  $T_C = 25^\circ\text{C}$  unless otherwise noted.

Symbol	Parameter	Value			Unit
		2N7000	2N7002	NDS7002A	
$V_{DSS}$	Drain-to-Source Voltage	60			V
$V_{DGR}$	Drain-Gate Voltage ( $R_{GS} \leq 1\text{ M}\Omega$ )	60			V
$V_{GSS}$	Gate-Source Voltage - Continuous	$\pm 20$			V
	Gate-Source Voltage - Non Repetitive ( $t_p < 50\ \mu\text{s}$ )	$\pm 40$			
$I_D$	Maximum Drain Current - Continuous	200	115	280	mA
	Maximum Drain Current - Pulsed	500	800	1500	
$P_D$	Maximum Power Dissipation Derated above $25^\circ\text{C}$	400	200	300	mW
		3.2	1.6	2.4	mW/ $^\circ\text{C}$
$T_J, T_{STG}$	Operating and Storage Temperature Range	-55 to 150		-65 to 150	$^\circ\text{C}$
$T_L$	Maximum Lead Temperature for Soldering Purposes, 1/16-inch from Case for 10 Seconds	300			$^\circ\text{C}$

## Thermal Characteristics

Values are at  $T_C = 25^\circ\text{C}$  unless otherwise noted.

Symbol	Parameter	Value			Unit
		2N7000	2N7002	NDS7002A	
$R_{\theta JA}$	Thermal Resistance, Junction to Ambient	312.5	625	417	$^\circ\text{C}/\text{W}$

## Electrical Characteristics

Values are at  $T_C = 25^\circ\text{C}$  unless otherwise noted.

Symbol	Parameter	Conditions	Type	Min.	Typ.	Max.	Unit
<b>Off Characteristics</b>							
$BV_{DSS}$	Drain-Source Breakdown Voltage	$V_{GS} = 0\text{ V}, I_D = 10\ \mu\text{A}$	All	60			V
$I_{DSS}$	Zero Gate Voltage Drain Current	$V_{DS} = 48\text{ V}, V_{GS} = 0\text{ V}$	2N7000			1	$\mu\text{A}$
		$V_{DS} = 48\text{ V}, V_{GS} = 0\text{ V}, T_C = 125^\circ\text{C}$				1	mA
		$V_{DS} = 60\text{ V}, V_{GS} = 0\text{ V}$	2N7002 NDS7002A			1	$\mu\text{A}$
		$V_{DS} = 60\text{ V}, V_{GS} = 0\text{ V}, T_C = 125^\circ\text{C}$				0.5	mA
$I_{GSSF}$	Gate - Body Leakage, Forward	$V_{GS} = 15\text{ V}, V_{DS} = 0\text{ V}$	2N7000			10	nA
		$V_{GS} = 20\text{ V}, V_{DS} = 0\text{ V}$	2N7002 NDS7002A			100	nA
$I_{GSSR}$	Gate - Body Leakage, Reverse	$V_{GS} = -15\text{ V}, V_{DS} = 0\text{ V}$	2N7000			-10	nA
		$V_{GS} = -20\text{ V}, V_{DS} = 0\text{ V}$	2N7002 NDS7002A			-100	nA

**Electrical Characteristics** (Continued)

Symbol	Parameter	Conditions	Type	Min.	Typ.	Max.	Unit
<b>On Characteristics</b>							
$V_{GS(th)}$	Gate Threshold Voltage	$V_{DS} = V_{GS}, I_D = 1 \text{ mA}$	2N7000	0.8	2.1	3	V
		$V_{DS} = V_{GS}, I_D = 250 \mu\text{A}$	2N7002 NDS7002A	1	2.1	2.5	
$R_{DS(ON)}$	Static Drain-Source On-Resistance	$V_{GS} = 10 \text{ V}, I_D = 500 \text{ mA}$	2N7000		1.2	5	$\Omega$
		$V_{GS} = 10 \text{ V}, I_D = 500 \text{ mA}, T_C = 125^\circ\text{C}$			1.9	9	
		$V_{GS} = 4.5 \text{ V}, I_D = 75 \text{ mA}$			1.8	5.3	
		$V_{GS} = 10 \text{ V}, I_D = 500 \text{ mA}$	2N7002		1.2	7.5	
		$V_{GS} = 10 \text{ V}, I_D = 500 \text{ mA}, T_C = 100^\circ\text{C}$			1.7	13.5	
		$V_{GS} = 5 \text{ V}, I_D = 50 \text{ mA}$			1.7	7.5	
		$V_{GS} = 5 \text{ V}, I_D = 50 \text{ mA}, T_C = 100^\circ\text{C}$			2.4	13.5	
		$V_{GS} = 10 \text{ V}, I_D = 500 \text{ mA}$	NDS7002A		1.2	2	
		$V_{GS} = 10 \text{ V}, I_D = 500 \text{ mA}, T_C = 125^\circ\text{C}$			2	3.5	
		$V_{GS} = 5 \text{ V}, I_D = 50 \text{ mA}$			1.7	3	
		$V_{GS} = 5 \text{ V}, I_D = 50 \text{ mA}, T_C = 125^\circ\text{C}$			2.8	5	
		$V_{DS(ON)}$	Drain-Source On-Voltage	$V_{GS} = 10 \text{ V}, I_D = 500 \text{ mA}$	2N7000		
$V_{GS} = 4.5 \text{ V}, I_D = 75 \text{ mA}$				0.14		0.4	
$V_{GS} = 10 \text{ V}, I_D = 500 \text{ mA}$	2N7002				0.6	3.75	
$V_{GS} = 5.0 \text{ V}, I_D = 50 \text{ mA}$					0.09	1.5	
$V_{GS} = 10 \text{ V}, I_D = 500 \text{ mA}$	NDS7002A				0.6	1	
$V_{GS} = 5.0 \text{ V}, I_D = 50 \text{ mA}$					0.09	0.15	
$I_{D(ON)}$	On-State Drain Current	$V_{GS} = 4.5 \text{ V}, V_{DS} = 10 \text{ V}$	2N7000	75	600		mA
		$V_{GS} = 10 \text{ V}, V_{DS} \geq 2 V_{DS(on)}$	2N7002	500	2700		
		$V_{GS} = 10 \text{ V}, V_{DS} \geq 2 V_{DS(on)}$	NDS7002A	500	2700		
$g_{FS}$	Forward Transconductance	$V_{DS} = 10 \text{ V}, I_D = 200 \text{ mA}$	2N7000	100	320		mS
		$V_{DS} \geq 2V_{DS(ON)}, I_D = 200 \text{ mA}$	2N7002	80	320		
		$V_{DS} \geq 2V_{DS(ON)}, I_D = 200 \text{ mA}$	NDS7002A	80	320		

**Electrical Characteristics** (Continued)

Symbol	Parameter	Conditions	Type	Min.	Typ.	Max.	Unit
<b>Dynamic Characteristics</b>							
$C_{ISS}$	Input Capacitance	$V_{DS} = 25\text{ V}, V_{GS} = 0\text{ V},$ $f = 1.0\text{ MHz}$	All		20	50	pF
$C_{OSS}$	Output Capacitance		All		11	25	
$C_{RSS}$	Reverse Transfer Capacitance		All		4	5	
$t_{on}$	Turn-On Time	$V_{DD} = 15\text{ V}, R_L = 25\ \Omega,$ $I_D = 500\text{ mA}, V_{GS} = 10\text{ V},$ $R_{GEN} = 25\ \Omega$	2N7000			10	ns
		$V_{DD} = 30\text{ V}, R_L = 150\ \Omega,$ $I_D = 200\text{ mA}, V_{GS} = 10\text{ V},$ $R_{GEN} = 25\ \Omega$	2N7002 NDS7002A			20	
$t_{off}$	Turn-Off Time	$V_{DD} = 15\text{ V}, R_L = 25\ \Omega,$ $I_D = 500\text{ mA}, V_{GS} = 10\text{ V},$ $R_{GEN} = 25\ \Omega$	2N7000			10	ns
		$V_{DD} = 30\text{ V}, R_L = 150\ \Omega,$ $I_D = 200\text{ mA}, V_{GS} = 10\text{ V},$ $R_{GEN} = 25\ \Omega$	2N7002 NDS7002A			20	
<b>Drain-Source Diode Characteristics and Maximum Ratings</b>							
$I_S$	Maximum Continuous Drain-Source Diode Forward Current		2N7002			115	mA
			NDS7002A			280	
$I_{SM}$	Maximum Pulsed Drain-Source Diode Forward Current		2N7002			0.8	A
			NDS7002A			1.5	
$V_{SD}$	Drain-Source Diode Forward Voltage	$V_{GS} = 0\text{ V},$ $I_S = 115\text{ mA}^{(1)}$	2N7002		0.88	1.5	V
		$V_{GS} = 0\text{ V},$ $I_S = 400\text{ mA}^{(1)}$	NDS7002A		0.88	1.2	

**Note:**

1. Pulse test : Pulse Width  $\leq 300\ \mu\text{s}$ , Duty Cycle  $\leq 2\%$ .

# Typical Performance Characteristics

2N7000 / 2N7002 / NDS7002A



Figure 1. On-Region Characteristics



Figure 2. On-Resistance Variation with Gate Voltage and Drain Current

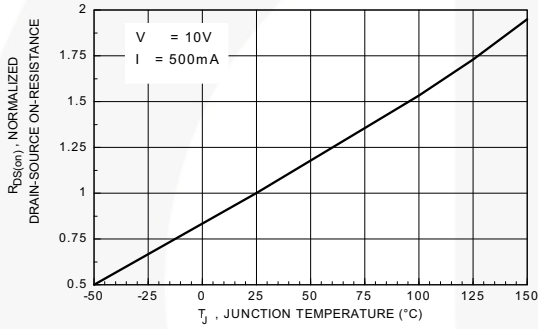

Figure 3. On-Resistance Variation with Temperature

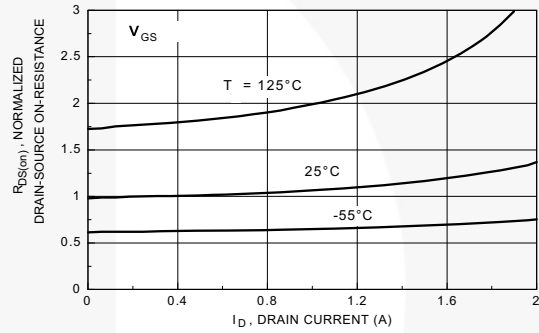

Figure 4. On-Resistance Variation with Drain Current and Temperature

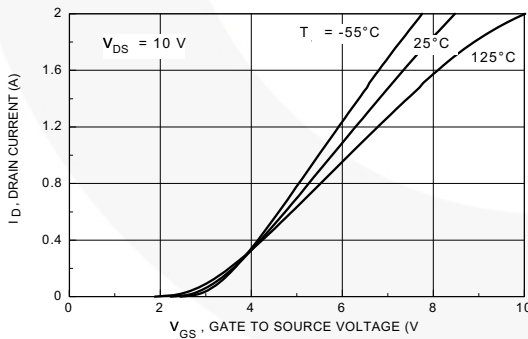

Figure 5. Transfer Characteristics

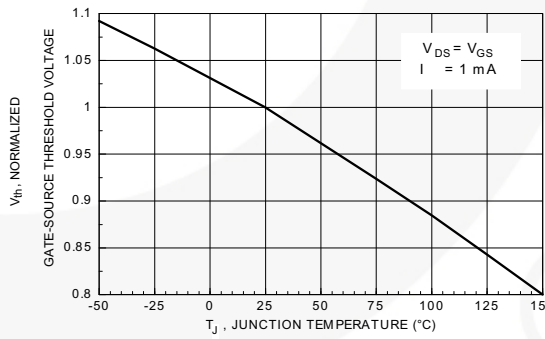

Figure 6. Gate Threshold Variation with Temperature

## Typical Performance Characteristics (Continued)

### 2N7000 / 2N7002 / NDS7002A



**Figure 7. Breakdown Voltage Variation with Temperature**

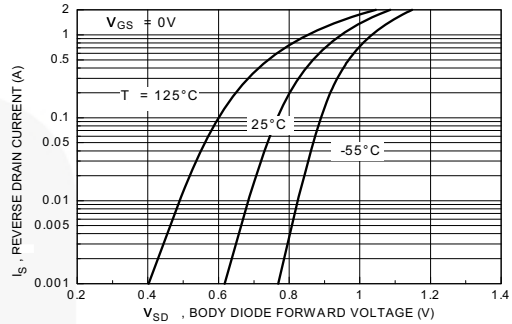

**Figure 8. Body Diode Forward Voltage Variation with Temperature**

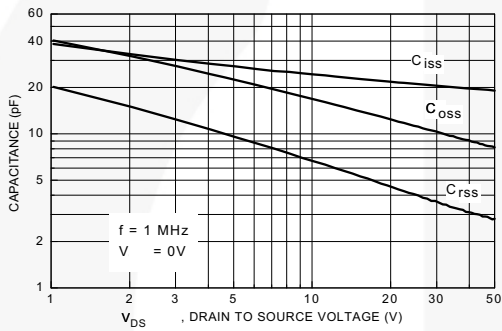

**Figure 9. Capacitance Characteristics**

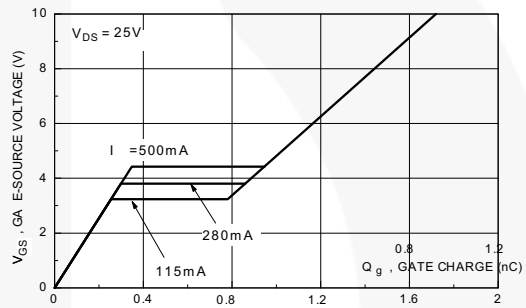

**Figure 10. Gate Charge Characteristics**

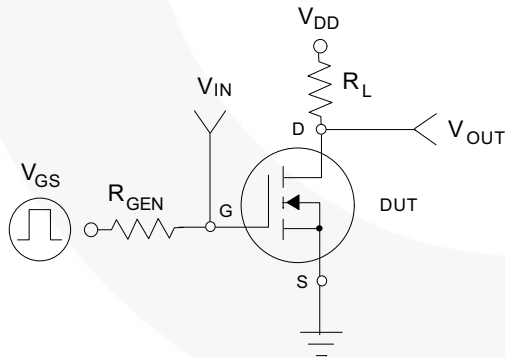

**Figure 11. Switching Test Circuit**

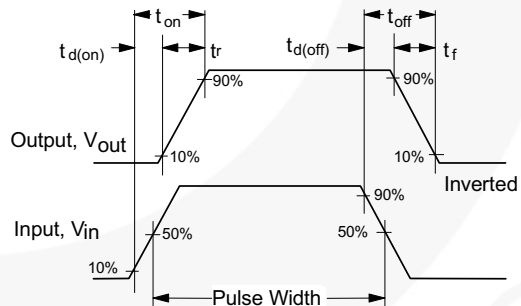

**Figure 12. Switching Waveforms**

Typical Performance Characteristics (Continued)



Figure 13. 2N7000 Maximum Safe Operating Area



Figure 14. 2N7002 Maximum Safe Operating Area

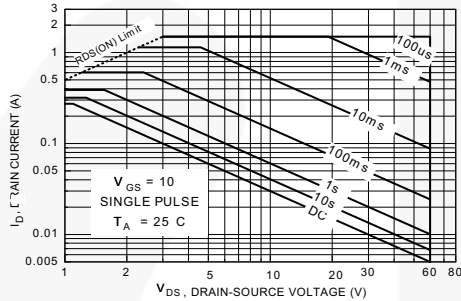

Figure 15. NDS7000A Maximum Safe Operating Area



Figure 16. TO-92, 2N7000 Transient Thermal Response Curve

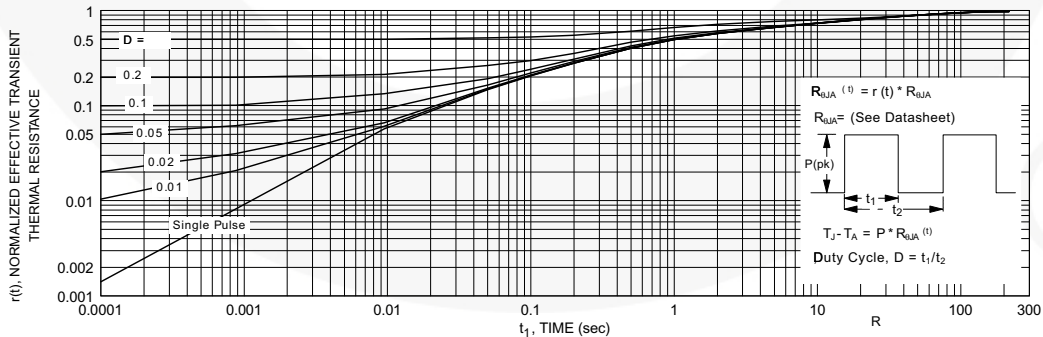

Figure 17. SOT-23, 2N7002 / NDS7002A Transient Thermal Response Curve





NOTES: UNLESS OTHERWISE SPECIFIED

- A. DRAWING CONFORMS TO JEDEC MS-013, VARIATION AC.
- B. ALL DIMENSIONS ARE IN MILLIMETERS.
- C. DRAWING CONFORMS TO ASME Y14.5M-2009.
- D. DRAWING FILENAME: MKT-ZA03FREV3.
- E. FAIRCHILD SEMICONDUCTOR.

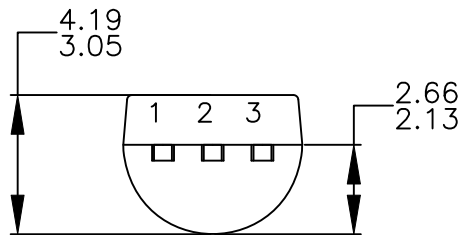
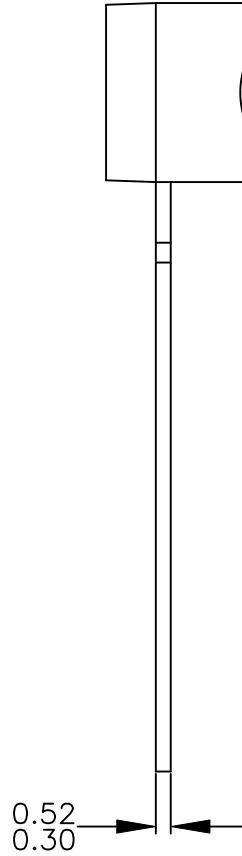

NOTES: UNLESS OTHERWISE SPECIFIED

- A) DRAWING WITH REFERENCE TO JEDEC TO-92 RECOMMENDATIONS.
- B) ALL DIMENSIONS ARE IN MILLIMETERS.
- C) DRAWING CONFORMS TO ASME Y14.5M-2009.
- D) DRAWING FILENAME: MKT-ZA03DREV4.





LAND PATTERN  
RECOMMENDATION



SEE DETAIL A

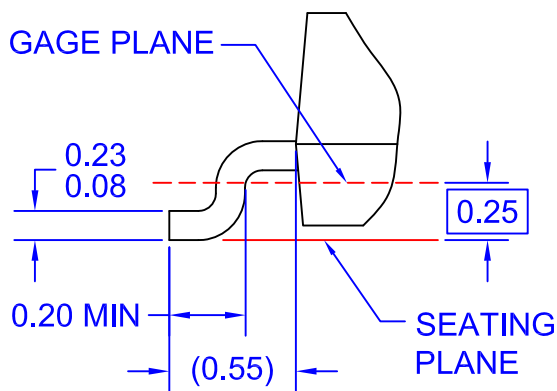
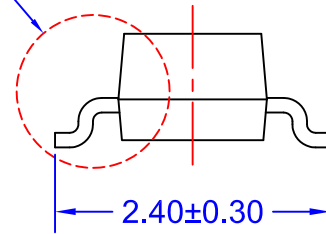

**DETAIL A**  
SCALE: 2X

NOTES: UNLESS OTHERWISE SPECIFIED

- A) REFERENCE JEDEC REGISTRATION TO-236, VARIATION AB, ISSUE H.
- B) ALL DIMENSIONS ARE IN MILLIMETERS.
- C) DIMENSIONS ARE INCLUSIVE OF BURRS, MOLD FLASH AND TIE BAR EXTRUSIONS.
- D) DIMENSIONING AND TOLERANCING PER ASME Y14.5M - 2009.
- E) DRAWING FILE NAME: MA03DREV12





**TRADEMARKS**

The following includes registered and unregistered trademarks and service marks, owned by Fairchild Semiconductor and/or its global subsidiaries, and is not intended to be an exhaustive list of all such trademarks.

- AccuPower™
- AttitudeEngine™
- Awinda®
- AX-CAP®\*
- BitSiC™
- Build it Now™
- CorePLUS™
- CorePOWER™
- CROSSVOL™
- CTL™
- Current Transfer Logic™
- DEUXPEED®
- Dual Cool™
- EcoSPARK®
- EfficientMax™
- ESBC™
- F**™
- Fairchild®
- Fairchild Semiconductor®
- FACT Quiet Series™
- FACT®
- FastvCore™
- FETBench™
- FPS™
- F-PFS™
- FRFET®
- Global Power Resource<sup>SM</sup>
- GreenBridge™
- Green FPS™
- Green FPS™ e-Series™
- Gmax™
- GTO™
- IntelliMAX™
- ISOPLANAR™
- Making Small Speakers Sound Louder and Better™
- MegaBuck™
- MICROCOUPLER™
- MicroFET™
- MicroPak™
- MicroPak2™
- MillerDrive™
- MotionMax™
- MotionGrid®
- MTi®
- MTx®
- MVN®
- mWSaver®
- OptoHiT™
- OPTOLOGIC®
- OPTOPLANAR®
- ®
- Power Supply WebDesigner™
- PowerTrench®
- PowerXS™
- Programmable Active Droop™
- QFET®
- QS™
- Quiet Series™
- RapidConfigure™
- ™
- Saving our world, 1mW/W/kW at a time™
- SignalWise™
- SmartMax™
- SMART START™
- Solutions for Your Success™
- SPM®
- STEALTH™
- SuperFET®
- SuperSOT™-3
- SuperSOT™-6
- SuperSOT™-8
- SupreMOS®
- SyncFET™
- Sync-Lock™
- ®
- TinyBoost®
- TinyBuck®
- TinyCalc™
- TinyLogic®
- TINYOPTO™
- TinyPower™
- TinyPWM™
- TinyWire™
- TranSiC™
- TriFault Detect™
- TRUECURRENT®\*
- μSerDes™
- ™
- UHC®
- Ultra FRFET™
- UniFET™
- VcX™
- VisualMax™
- VoltagePlus™
- XS™
- Xsens™
- 仙童®

\* Trademarks of System General Corporation, used under license by Fairchild Semiconductor.

**DISCLAIMER**

FAIRCHILD SEMICONDUCTOR RESERVES THE RIGHT TO MAKE CHANGES WITHOUT FURTHER NOTICE TO ANY PRODUCTS HEREIN TO IMPROVE RELIABILITY, FUNCTION, OR DESIGN. TO OBTAIN THE LATEST, MOST UP-TO-DATE DATASHEET AND PRODUCT INFORMATION, VISIT OUR WEBSITE AT [HTTP://WWW.FAIRCHILDSEMI.COM](http://www.fairchildsemi.com). FAIRCHILD DOES NOT ASSUME ANY LIABILITY ARISING OUT OF THE APPLICATION OR USE OF ANY PRODUCT OR CIRCUIT DESCRIBED HEREIN; NEITHER DOES IT CONVEY ANY LICENSE UNDER ITS PATENT RIGHTS, NOR THE RIGHTS OF OTHERS. THESE SPECIFICATIONS DO NOT EXPAND THE TERMS OF FAIRCHILD'S WORLDWIDE TERMS AND CONDITIONS, SPECIFICALLY THE WARRANTY THEREIN, WHICH COVERS THESE PRODUCTS.

**AUTHORIZED USE**

Unless otherwise specified in this data sheet, this product is a standard commercial product and is not intended for use in applications that require extraordinary levels of quality and reliability. This product may not be used in the following applications, unless specifically approved in writing by a Fairchild officer: (1) automotive or other transportation, (2) military/aerospace, (3) any safety critical application – including life critical medical equipment – where the failure of the Fairchild product reasonably would be expected to result in personal injury, death or property damage. Customer's use of this product is subject to agreement of this Authorized Use policy. In the event of an unauthorized use of Fairchild's product, Fairchild accepts no liability in the event of product failure. In other respects, this product shall be subject to Fairchild's Worldwide Terms and Conditions of Sale, unless a separate agreement has been signed by both Parties.

**ANTI-COUNTERFEITING POLICY**

Fairchild Semiconductor Corporation's Anti-Counterfeiting Policy. Fairchild's Anti-Counterfeiting Policy is also stated on our external website, [www.fairchildsemi.com](http://www.fairchildsemi.com), under Terms of Use

Counterfeiting of semiconductor parts is a growing problem in the industry. All manufacturers of semiconductor products are experiencing counterfeiting of their parts. Customers who inadvertently purchase counterfeit parts experience many problems such as loss of brand reputation, substandard performance, failed applications, and increased cost of production and manufacturing delays. Fairchild is taking strong measures to protect ourselves and our customers from the proliferation of counterfeit parts. Fairchild strongly encourages customers to purchase Fairchild parts either directly from Fairchild or from Authorized Fairchild Distributors who are listed by country on our web page cited above. Products customers buy either from Fairchild directly or from Authorized Fairchild Distributors are genuine parts, have full traceability, meet Fairchild's quality standards for handling and storage and provide access to Fairchild's full range of up-to-date technical and product information. Fairchild and our Authorized Distributors will stand behind all warranties and will appropriately address any warranty issues that may arise. Fairchild will not provide any warranty coverage or other assistance for parts bought from Unauthorized Sources. Fairchild is committed to combat this global problem and encourage our customers to do their part in stopping this practice by buying direct or from authorized distributors.

**PRODUCT STATUS DEFINITIONS**

**Definition of Terms**

Datasheet Identification	Product Status	Definition
Advance Information	Formative / In Design	Datasheet contains the design specifications for product development. Specifications may change in any manner without notice.
Preliminary	First Production	Datasheet contains preliminary data; supplementary data will be published at a later date. Fairchild Semiconductor reserves the right to make changes at any time without notice to improve design.
No Identification Needed	Full Production	Datasheet contains final specifications. Fairchild Semiconductor reserves the right to make changes at any time without notice to improve the design.
Obsolete	Not In Production	Datasheet contains specifications on a product that is discontinued by Fairchild Semiconductor. The datasheet is for reference information only.

Rev. I77

# Mouser Electronics

Authorized Distributor

Click to View Pricing, Inventory, Delivery & Lifecycle Information:

[Fairchild Semiconductor:](#)

[2N7002\\_D87Z](#) [2N7000\\_D75Z](#) [2N7002](#) [NDS7002A](#) [2N7000](#) [2N7000\\_D74Z](#) [2N7000\\_D26Z](#)