

# Power MOSFET Stage for Boost Converters

Module for Power Factor Correction

Single Phase Rectifier	Boost Diode	MOSFET
$V_{RRM} = 1600 \text{ V}$	$V_{RRM} = 600 \text{ V}$	$V_{DSS} = 600 \text{ V}$
$I_{DAV} = 106 \text{ A}$	$I_{F25} = 60 \text{ A}$	$I_{D25} = 50 \text{ A}$
$I_{FSM} = 300 \text{ A}$	$V_F(30A) = 2.24 \text{ V}$	$R_{DS(on)} = 120 \text{ m}\Omega$

**Part name** (Marking on product)

VUM33-06PH

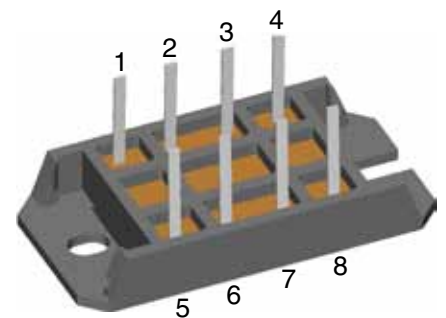
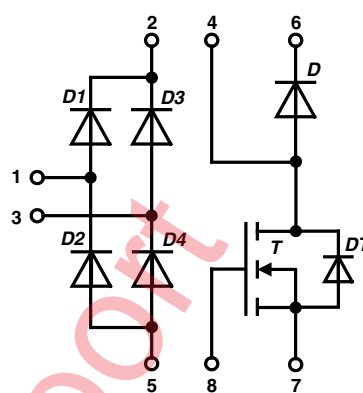

**Features:**

- Package with DCB ceramic base plate
- Soldering connections for PCB mounting
- Isolation voltage 3600 V~
- Low  $R_{DS(on)}$  Polar™ MOSFET
- Low package inductance for high speed switching
- SONIC™ boost diode
  - fast and soft reverse recovery
  - low operating forward voltage

**Advantages:**

- 3 functions in one package
- Output power up to 8 kW
- No external isolation
- Easy to mount with two screws
- Suitable for wave soldering
- High temperature and power cycling capability
- Fits easily to all available PFC controller ICs

**Package:**

- "V1-Pack" standard outline
- Insulated copper base plate

**Application:**

- Power factor pre-conditioner for SMPS, UPS, battery chargers and inverters
- Boost topology for SMPS including 1~ rectifier bridge
- Power supply for welding equipment

MOSFET T				Ratings		
Symbol	Definitions	Conditions	min.	typ.	max.	Unit
$V_{DSS}$	drain source voltage				600	V
$V_{GSS}$	max. DC gate voltage	continuous			±20	V
$V_{GSM}$	max. transient gate source voltage	transient			±30	V
$I_{D25}$	drain current		$T_C = 25^\circ\text{C}$		50	A
$I_{D80}$			$T_C = 80^\circ\text{C}$		37	A
$P_{tot}$	total power dissipation		$T_C = 80^\circ\text{C}$		500	W
$R_{DS(on)}$	drain source on resistance	$I_D = 30\text{ A}; V_{GE} = 10\text{ V}$	$T_{VJ} = 25^\circ\text{C}$ $T_{VJ} = 125^\circ\text{C}$		120 240	mΩ mΩ
$V_{GS(th)}$	gate source threshold voltage	$I_C = 8\text{ mA}; V_{DS} = V_{GS}$	$T_{VJ} = 25^\circ\text{C}$	2.5	5.0	V
$I_{DSS}$	drain source leakage current	$V_{DS} = V_{DSS}; V_{GS} = 0\text{ V}$	$T_{VJ} = 25^\circ\text{C}$ $T_{VJ} = 125^\circ\text{C}$		50 500	μA μA
$I_{GSS}$	gate source leakage current	$V_{GS} = \pm 20\text{ V}; V_{DS} = 0\text{ V}$			±500	nA
$C_{iss}$	input capacitance	$V_{DS} = 25\text{ V}; V_{GS} = 0\text{ V}; f = 1\text{ MHz}$		8.0		nF
$Q_{G(on)}$	total gate charge	$V_{DS} = 300\text{ V}; V_{GS} = 10\text{ V}; I_D = 50\text{ A}$		165		nC
$t_{d(on)}$	turn-on delay time	inductive load $V_{DS} = 380\text{ V}; I_D = 20\text{ A}$ $V_{GS} = 0/10\text{ V}; R_G = 4.7\ \Omega$ $R_{G\text{ eff}} = 5.5\ \Omega$ <sup>1)</sup>	$T_{VJ} = 25^\circ\text{C}$	56		ns
$t_r$	current rise time			12		ns
$t_{d(off)}$	turn-off delay time			110		ns
$t_f$	current fall time			12		ns
$E_{on}$	turn-on energy per pulse			0.3		mJ
$E_{off}$	turn-off energy per pulse			0.16		mJ
$t_{d(on)}$	turn-on delay time	inductive load $V_{DS} = 380\text{ V}; I_D = 20\text{ A}$ $V_{GS} = 0/10\text{ V}; R_G = 4.7\ \Omega$ $R_{G\text{ eff}} = 5.5\ \Omega$ <sup>1)</sup>	$T_{VJ} = 125^\circ\text{C}$	56		ns
$t_r$	current rise time			16		ns
$t_{d(off)}$	turn-off delay time			144		ns
$t_f$	current fall time			14		ns
$E_{on}$	turn-on energy per pulse			0.47		mJ
$E_{off}$	turn-off energy per pulse			0.20		mJ
$R_{thJC}$	thermal resistance junction to case				0.14	K/W
$R_{thJH}$	thermal resistance case to heatsink	with heat transfer paste (IXYS test setup)		0.18	0.24	K/W

<sup>1)</sup>  $R_{G\text{ eff}}$  includes the driver resistance of 0.8 Ω

**Boost Diode D**

Symbol	Definitions	Conditions	Ratings			Unit
			min.	typ.	max.	
$V_{RRM}$	max. repetitive reverse voltage				600	V
$I_{F25}$	forward current				60	A
$I_{F80}$					40	A
$V_F$	forward voltage	$I_F = 30\text{ A}; V_{GE} = 0\text{ V}$			2.24	V
					2.19	V
$I_R$	reverse current	$V_R = V_{RRM}$			30	$\mu\text{A}$
					2	mA
$Q_{rr}$	reverse recovery charge	$V_R = 380\text{ V}$ $di_f/dt = -790\text{ A}/\mu\text{s}$ <sup>2)</sup> $I_F = 20\text{ A}$			0.24	$\mu\text{C}$
$I_{RM}$	max. reverse recovery current				11.7	A
$t_{rr}$	reverse recovery time				43	ns
$E_{rec}$	reverse recovery energy				0.026	mJ
$Q_{rr}$	reverse recovery charge	$V_R = 380\text{ V}$ $di_f/dt = -700\text{ A}/\mu\text{s}$ <sup>2)</sup> $I_F = 20\text{ A}$			0.59	$\mu\text{C}$
$I_{RM}$	max. reverse recovery current				15.9	A
$t_{rr}$	reverse recovery time				55	ns
$E_{rec}$	reverse recovery energy				0.076	mJ
$R_{thJC}$	thermal resistance junction to case	with heat transfer paste (IXYS test setup)			0.72	K/W
$R_{thJH}$	thermal resistance case to heatsink				0.84	0.96

<sup>2)</sup> Test setup: MOSFET T driven with  $R_{G\text{eff}} = 5.5\ \Omega$  and  $V_{GS} = 0/10\text{ V}$ 
**Input Rectifier Bridge D1 - D4**

Symbol	Definitions	Conditions	Ratings			Unit	
			min.	typ.	max.		
$V_{RRM}$	max. repetitive reverse voltage				1600	V	
$I_{DAV}$	average forward output current	sine 180°			106	A	
$I_{FAVM}$	max. average forward current (per diode)	rect.; $d = 0.5$			57	A	
$I_{F25}$	forward current	DC			106	A	
$I_{F80}$	forward current	DC			71.5	A	
$I_{FSM}$	max. forward surge current	$t = 10\text{ ms}; \text{ sine } 50\text{ Hz}$			300	A	
					170	A	
$I^2t$	$I^2t$ value for fusing	$t = 10\text{ ms}; \text{ sine } 50\text{ Hz}$			450	$\text{A}^2\text{s}$	
					240	$\text{A}^2\text{s}$	
$P_{tot}$	total power dissipation				110	W	
$V_F$	forward voltage	$I_F = 50\text{ A}$			1.39	V	
					1.39	V	
$I_R$	reverse current	$V_R = V_{RRM}$			20	$\mu\text{A}$	
					1.5	mA	
$R_{thJC}$	thermal resistance junction to case	(per diode)			0.64	K/W	
$R_{thJH}$	thermal resistance case to heatsink	with heat transfer paste (IXYS test setup)			0.72	0.85	K/W

**Module**

Symbol	Definitions	Conditions	Ratings			Unit
			min.	typ.	max.	
$T_{VJ}$	operating temperature		-40		150	°C
$T_{VJM}$	max. virtual junction temperature		-40		150	°C
$T_{stg}$	storage temperature		-40		125	°C
$V_{ISOL}$	isolation voltage	$I_{ISOL} \leq 1\text{ mA}; 50/60\text{ Hz}; 1\text{ sec.}$			3600	V~
$M_d$	mounting torque (M5)		2		2.5	Nm
<b>Weight</b>				35		g

 $T_C = 25^\circ\text{C}$  unless otherwise stated

**Outline Drawing**

Dimensions in mm (1 mm = 0.0394")

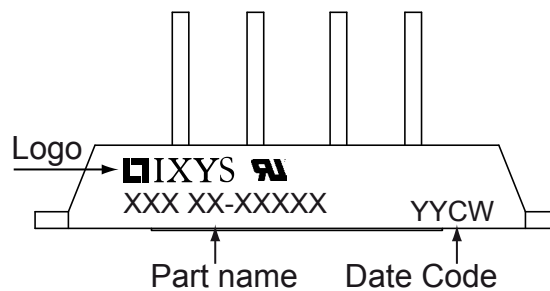
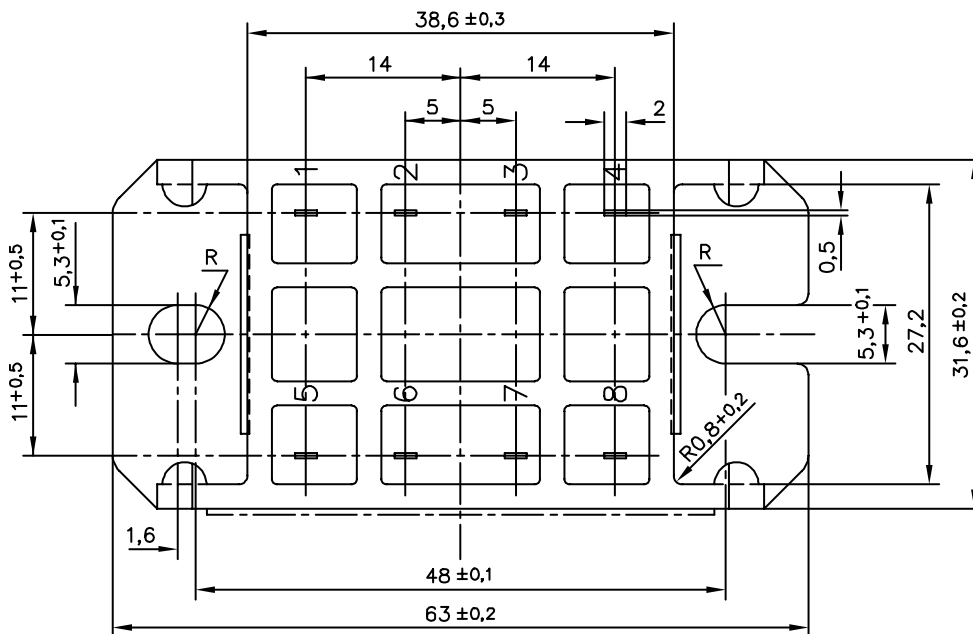
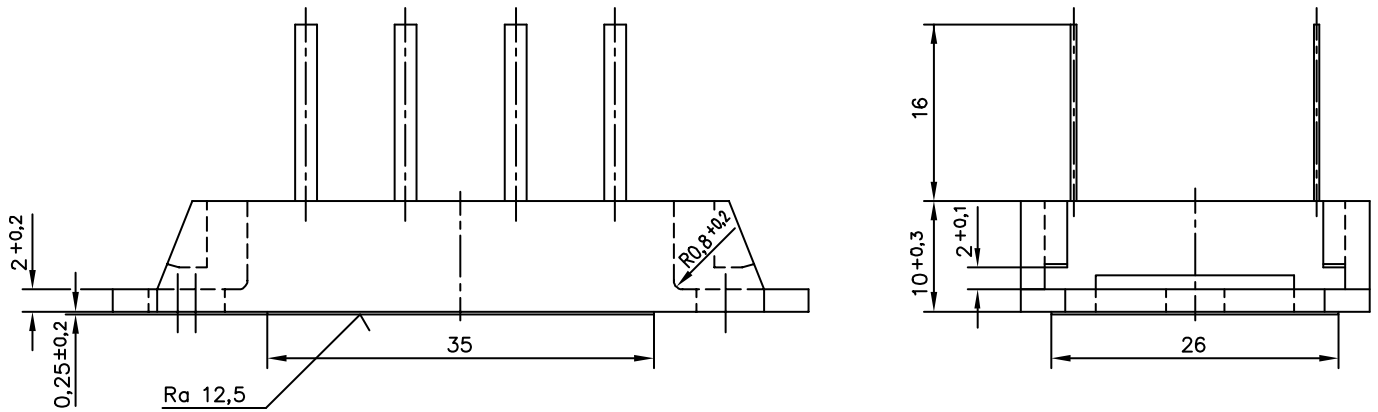
**Product Ordering**

Ordering	Part Name	Marking on Product	Delivering Mode	Base Qty	Ordering Code
Standard	VUM 33-06PH	VUM 33-06PH	Box	10	508843

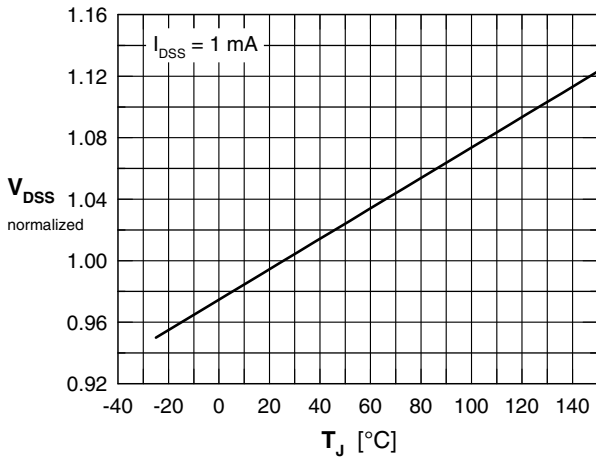

Fig. 1 Drain source breakdown voltage  $V_{DSS}$  versus junction temperature

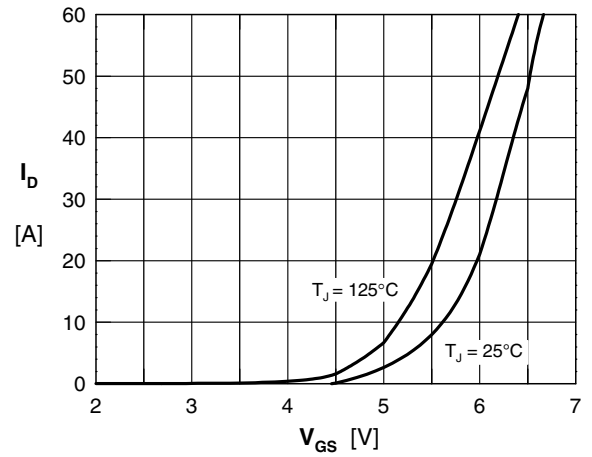

Fig. 2 Typical transfer characteristics

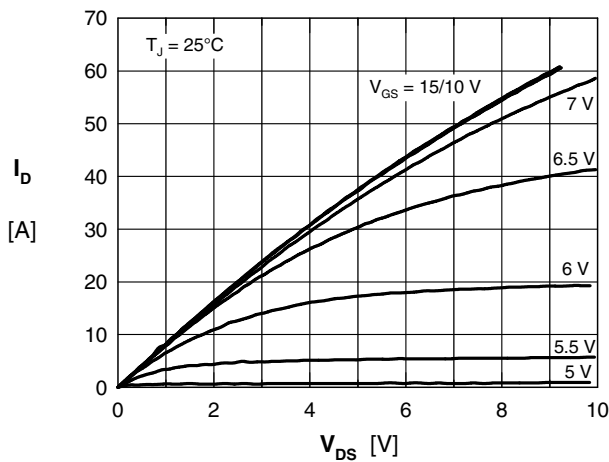

Fig. 3 Typical output characteristics

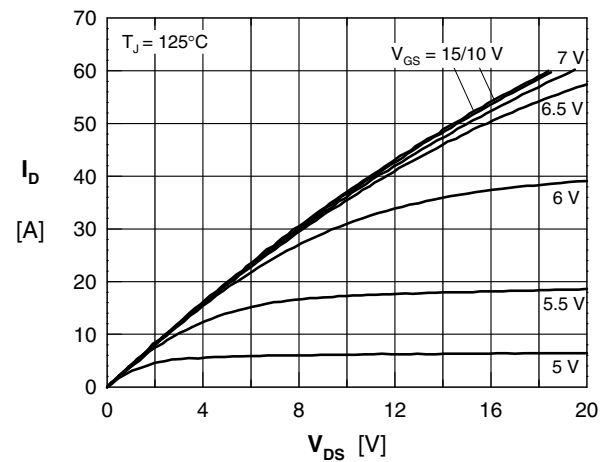

Fig. 4 Typical output characteristics

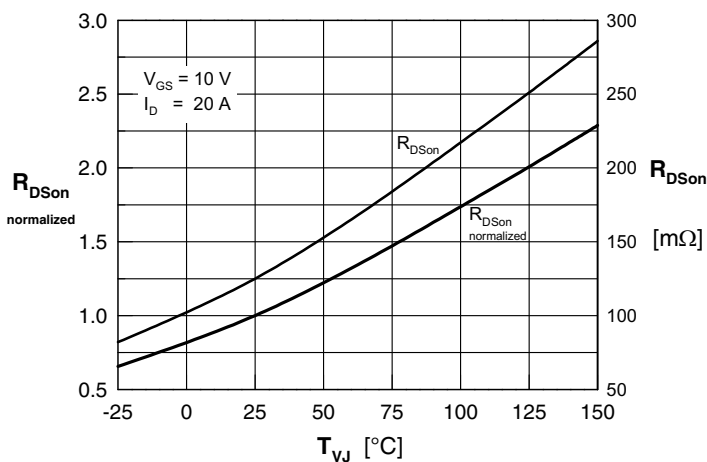

Fig. 5 Drain source on-state resistance  $R_{DS(on)}$  versus junction temperature

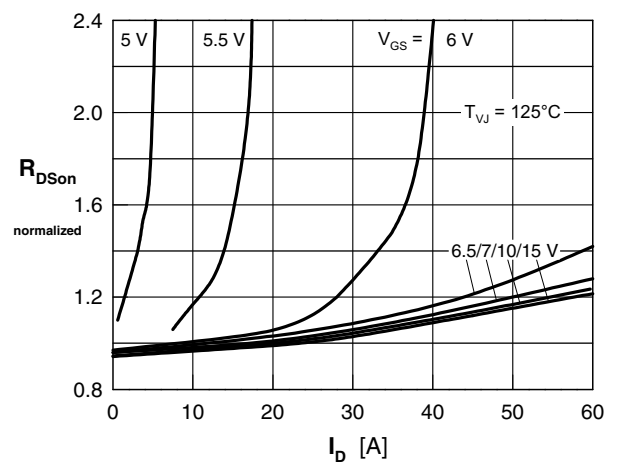

Fig. 6 Drain source on-state resistance  $R_{DS(on)}$  versus  $I_D$  normalized to  $R_{DS(on)}$  at  $V_{GS} = 10 \text{ V}$  and  $I_D = 20 \text{ A}$

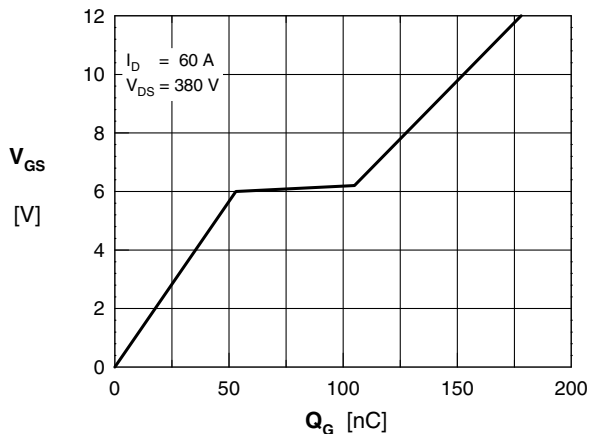

Fig. 7 Gate charge characteristics

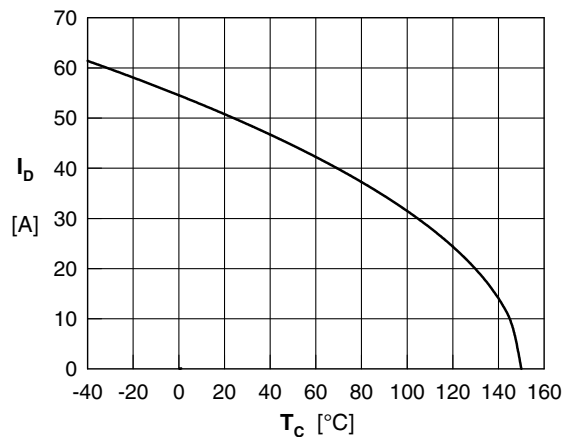
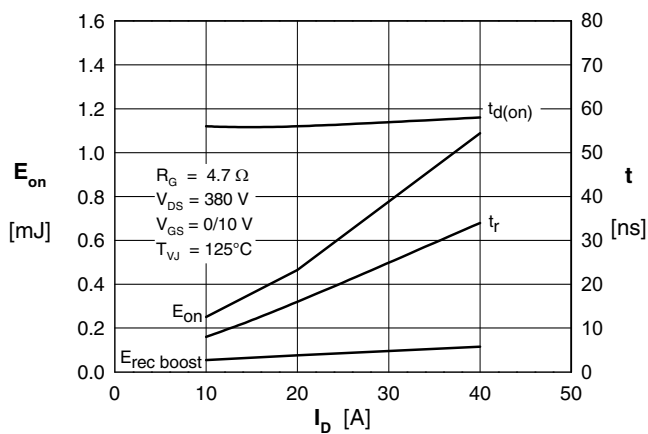

 Fig. 8 Drain current  $I_D$  versus case temperature  $T_C$ 

Fig. 9 Typ. turn-on energy and switching times versus drain current, inductive switching

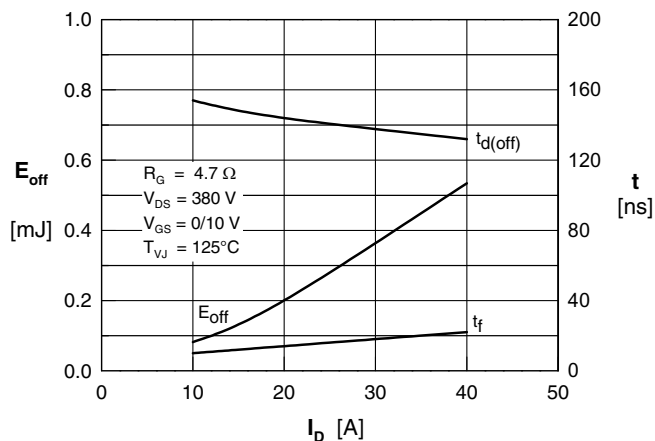

Fig. 10 Typ. turn-off energy and switching times versus drain current, inductive switching

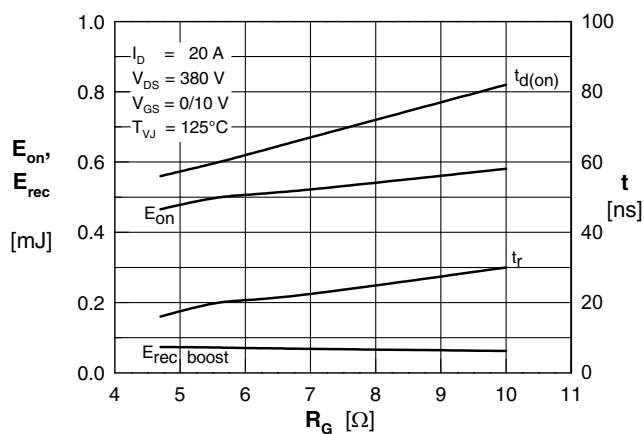

Fig. 11 Typ. turn-on energy and switching times versus gate resistor, inductive switching

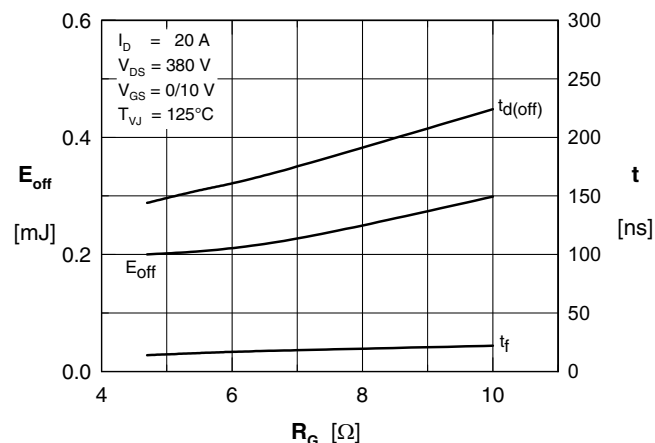

Fig. 12 Typ. turn-off energy and switching times versus gate resistor, inductive switching

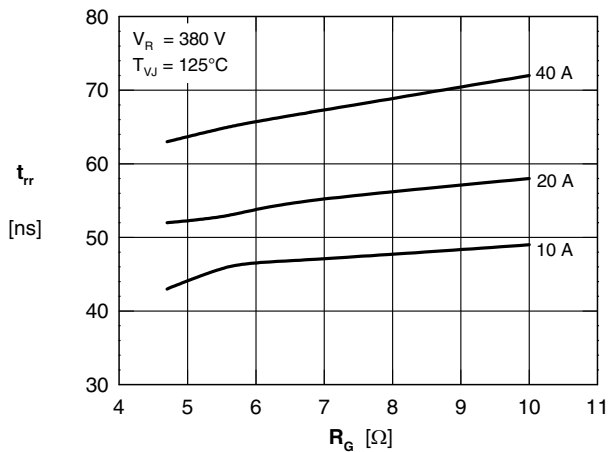

Fig. 13 Reverse recovery time  $t_{rr}$  of the boost diode versus  $R_G$  of boost MOSFET

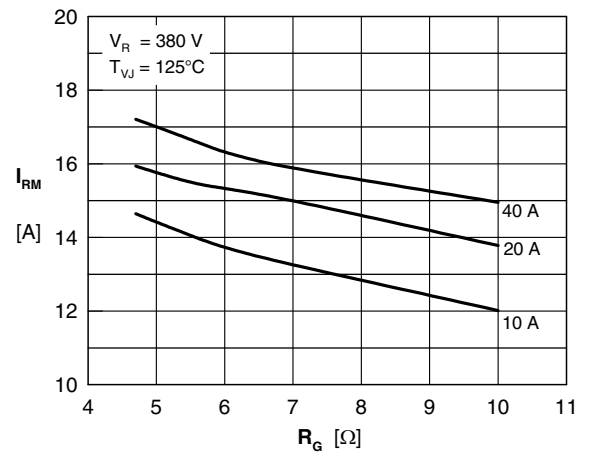

Fig. 14 Reverse recovery current  $I_{RM}$  of the boost diode versus  $R_G$  of the boost MOSFET

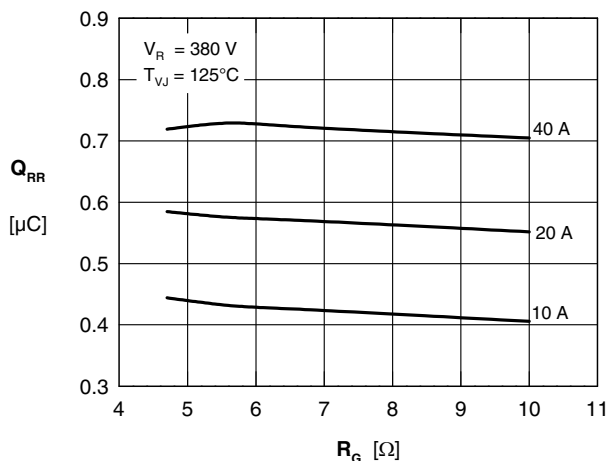

Fig. 15 Reverse recovery charge  $Q_{RR}$  of the boost diode versus  $R_G$

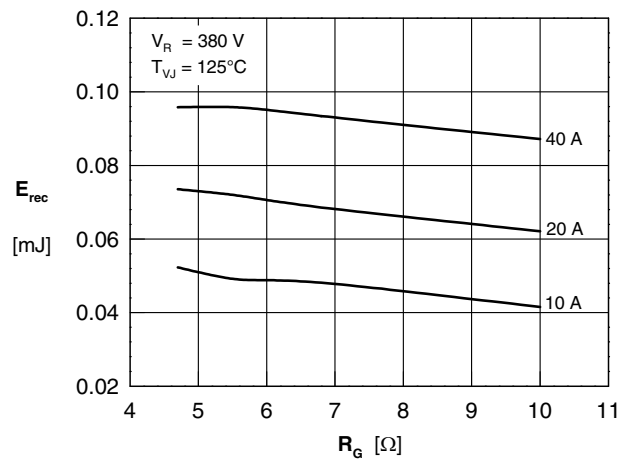

Fig. 16 Reverse recovery energy  $E_{rec}$  of the boost diode versus  $R_G$

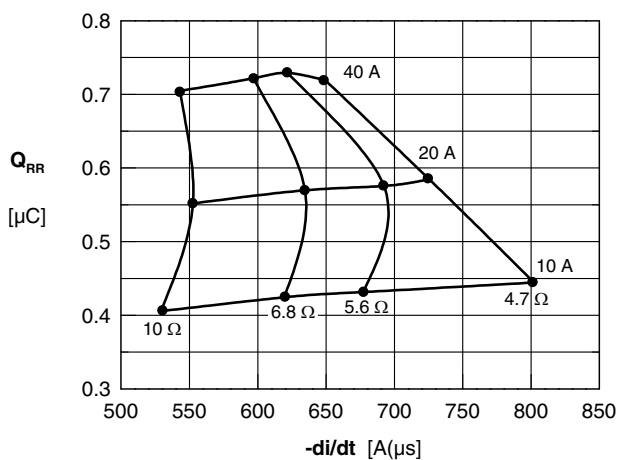

Fig. 17 Typ. turn off characteristics of the boost diode versus  $di/dt$

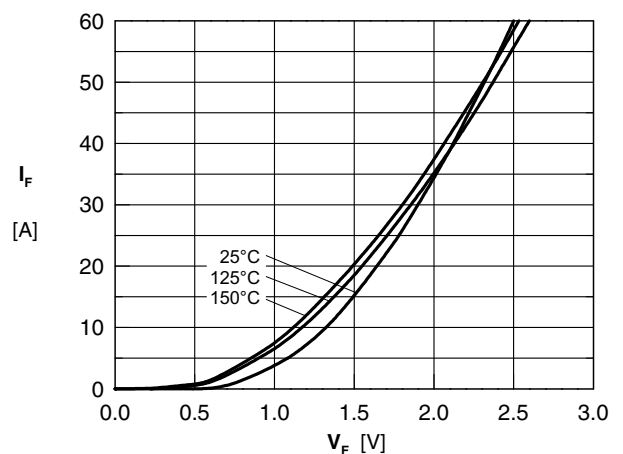

Fig. 18 Forward characteristics boost diode

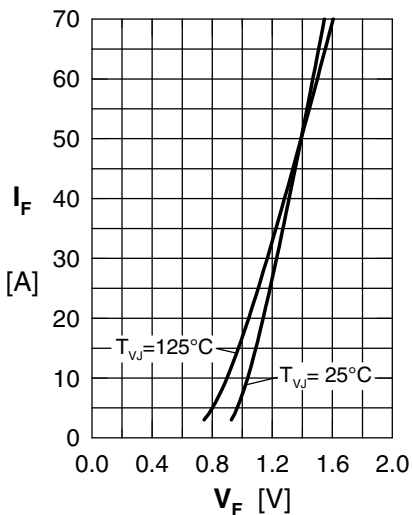

Fig. 19 Forward current vs. voltage drop of input rectifier diode

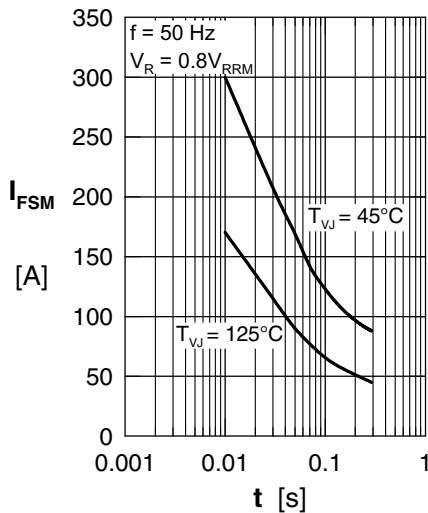

Fig. 20 Non-repetitive peak surge current (Rectifier Diodes)

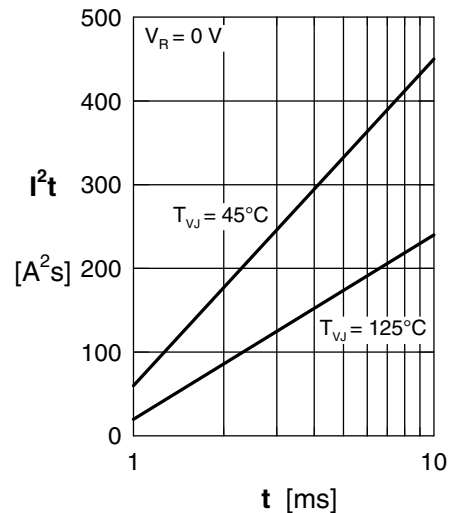

Fig. 21  $I^2t$  for fusing (Rectifier Diodes)

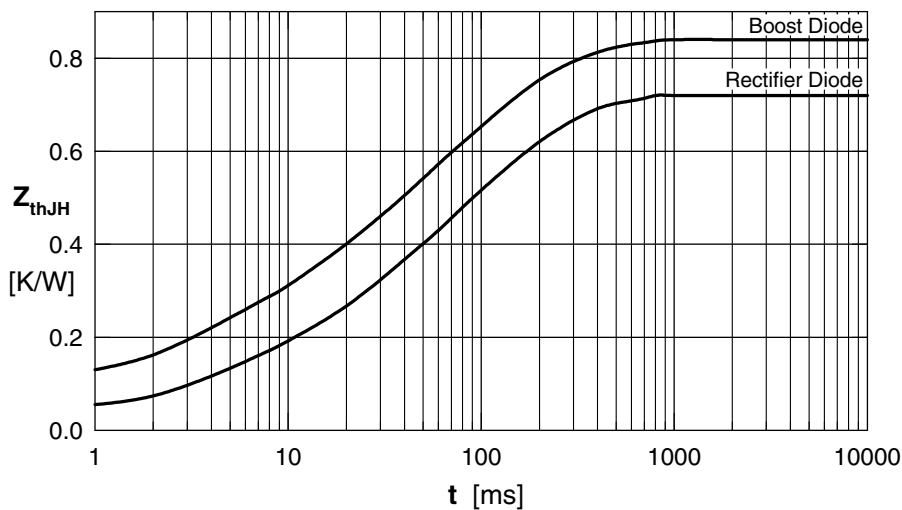

Fig. 22 Typ. transient thermal impedances of Boost Diode and Rectifier Diode

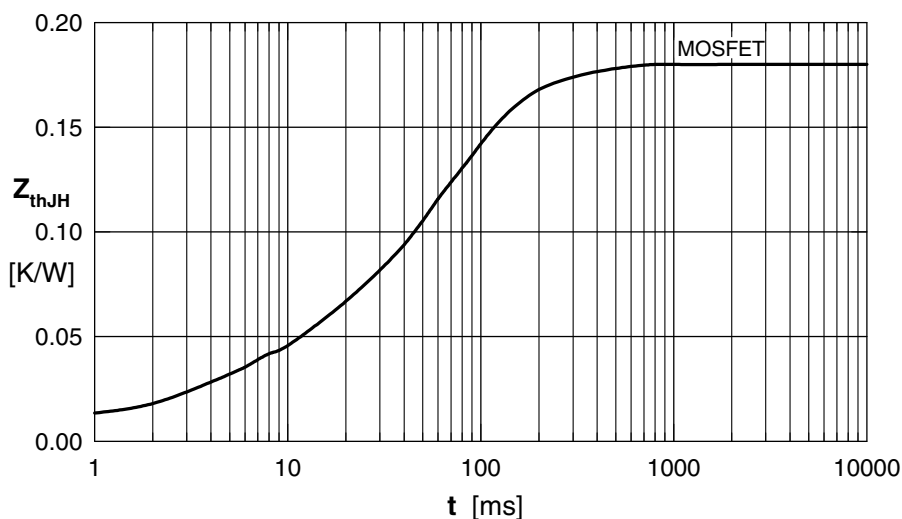

Fig. 23 Typ. transient thermal impedances of MOSFET