

Overvoltage protected AC switch (ACS™)

Datasheet – production data

Features

- Enables equipment to meet IEC 61000-4-5 surge with overvoltage crowbar technology
- High noise immunity against static dV/dt and IEC 61000-4-4 burst
- Needs no external protection snubber or varistor
- Reduces component count by up to 80% and interfaces directly with the micro-controller
- Common package tab connection supports connection of several alternating current switches on the same cooling pad
- V_{CL} gives headroom before clamping then crowbar action

Applications

- Alternating current on/off static switching in appliances and industrial control systems
- Driving low power high inductive or resistive loads like:
 - relay, valve, solenoid, dispenser,
 - pump, fan, low power motor, door lock
 - lamp

Description

The ACS108 belongs to the AC switch range (built with A. S. D.® technology). This high performance switch can control a load of up to 0.8 A. The ACS108 switch includes an overvoltage crowbar structure to absorb the inductive turn-off energy, and a gate level shifter driver to separate the digital controller from the main switch. It is triggered with a negative gate current flowing out of the gate pin.

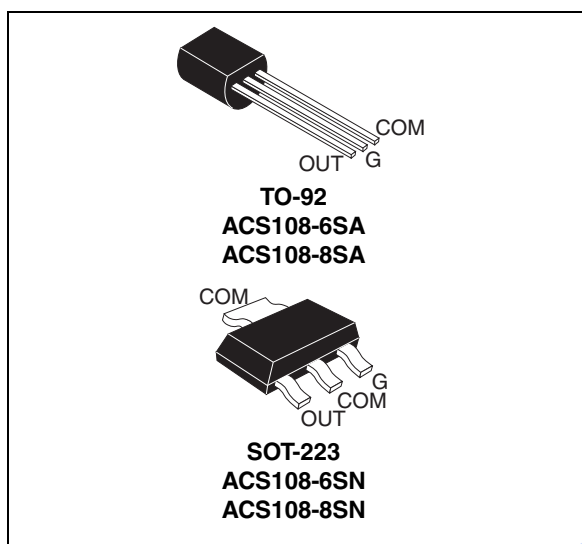

Figure 1. Functional diagram

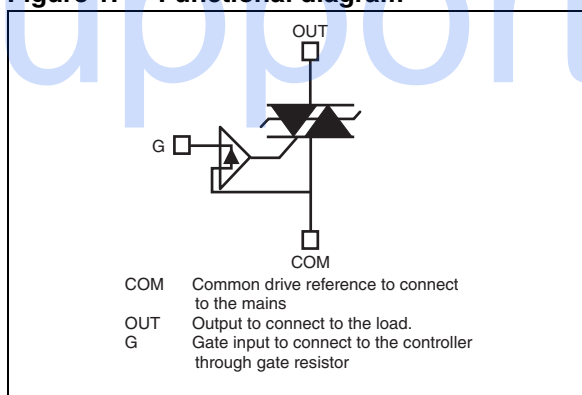

Table 1. Device summary

Symbol	Value	Unit
$I_{T(RMS)}$	0.8	A
V_{DRM}, V_{RRM}	600 and 800	V
I_{GT}	10	mA

®: A.S.D. is a registered trademark of STMicroelectronics

TM: ACS is a trademark of STMicroelectronics

1 Characteristics

Table 2. Absolute maximum ratings ($T_{amb} = 25\text{ °C}$, unless otherwise specified)

Symbol	Parameter		Value	Unit	
$I_{T(RMS)}$	On-state rms current (full sine wave)	TO-92	$T_{amb} = 64\text{ °C}$	0.45	A
			$T_{lead} = 76\text{ °C}$	0.8	A
		SOT-223 $S = 5\text{ cm}^2$	$T_{amb} = 76\text{ °C}$		
			$T_{tab} = 104\text{ °C}$		
I_{TSM}	Non repetitive surge peak on-state current (full cycle sine wave, T_j initial = 25 °C)	F = 60 Hz	t = 16.7 ms	13.7	A
		F = 50 Hz	t = 20 ms	13	
I^2t	I^2t Value for fusing		$t_p = 10\text{ ms}$	1.1	A^2s
dI/dt	Critical rate of rise of on-state current $I_G = 2 \times I_{GT}$, $t_r \leq 100\text{ ns}$	F = 120 Hz	$T_j = 125\text{ °C}$	100	A/ μs
V_{PP}	Non repetitive mains peak mains voltage ⁽¹⁾			2	kV
I_{GM}	Peak gate current	$t_p = 20\text{ }\mu s$	$T_j = 125\text{ °C}$	1	A
V_{GM}	Peak positive gate voltage		$T_j = 125\text{ °C}$	10	V
$P_{G(AV)}$	Average gate power dissipation		$T_j = 125\text{ °C}$	0.1	W
T_{stg} T_j	Storage junction temperature range Operating junction temperature range			-40 to +150 -30 to +125	$^{\circ}C$

1. According to test described by IEC 61000-4-5 standard and [Figure 18](#)

Table 3. Electrical characteristics ($T_j = 25\text{ °C}$, unless otherwise specified)

Symbol	Test conditions	Quadrant		Value	Unit
$I_{GT}^{(1)}$	$V_{OUT} = 12\text{ V}$, $R_L = 33\text{ }\Omega$	II - III	Max.	10	mA
V_{GT}		II - III	Max.	1	V
V_{GD}	$V_{OUT} = V_{DRM}$, $R_L = 3.3\text{ k}\Omega$, $T_j = 125\text{ °C}$	II - III	Min.	0.15	V
I_H	$I_{OUT} = 100\text{ mA}$		Max.	10	mA
I_L	$I_G = 1.2 \times I_{GT}$		Max.	25	mA
dV/dt	$V_{OUT} = 402\text{ V}$, gate open, $T_j = 125\text{ °C}$		Min.	2000	V/ μs
	$V_{OUT} = 536\text{ V}$, gate open, $T_j = 125\text{ °C}$		Min.	400	V/ μs
(dI/dt)c	Without snubber (15 V/ μs), $T_j = 125\text{ °C}$, turn-off time $\leq 20\text{ ms}$		Min.	2	A/ms
V_{CL}	$I_{CL} = 0.1\text{ mA}$, $t_p = 1\text{ ms}$, ACS108-6		Min.	650	V
	$I_{CL} = 0.1\text{ mA}$, $t_p = 1\text{ ms}$, ACS108-8		Min.	850	V

1. Minimum I_{GT} is guaranteed at 10% of I_{GT} max

Table 4. Static electrical characteristics

Symbol	Parameter and test conditions			Value	Unit
$V_{TM}^{(1)}$	$I_{TM} = 1.1 \text{ A}$, $t_p = 500 \mu\text{s}$	$T_j = 25 \text{ }^\circ\text{C}$	Max.	1.3	V
$V_{i0}^{(1)}$	Threshold voltage	$T_j = 125 \text{ }^\circ\text{C}$	Max.	0.85	V
$R_D^{(1)}$	Dynamic resistance	$T_j = 125 \text{ }^\circ\text{C}$	Max.	300	m Ω
I_{DRM} I_{RRM}	$V_{OUT} = V_{DRM} = V_{RRM}$	$T_j = 25 \text{ }^\circ\text{C}$	Max.	2	μA
		$T_j = 125 \text{ }^\circ\text{C}$		0.2	mA

1. For both polarities of OUT referenced to COM

Table 5. Thermal resistance

Symbol	Parameter			Value	Unit
$R_{th(j-l)}$	Junction to lead (AC)	TO-92	Max.	60	$^\circ\text{C/W}$
$R_{th(j-t)}$	Junction to tab (AC)	SOT-223	Max.	25	
$R_{th(j-a)}$	Junction to ambient	TO-92	Max.	150	
		$S = 5 \text{ cm}^2$	SOT-223	Max.	

Figure 2. Maximum power dissipation versus on-state rms current **Figure 3. On-state rms current versus case temperature (SOT223)**

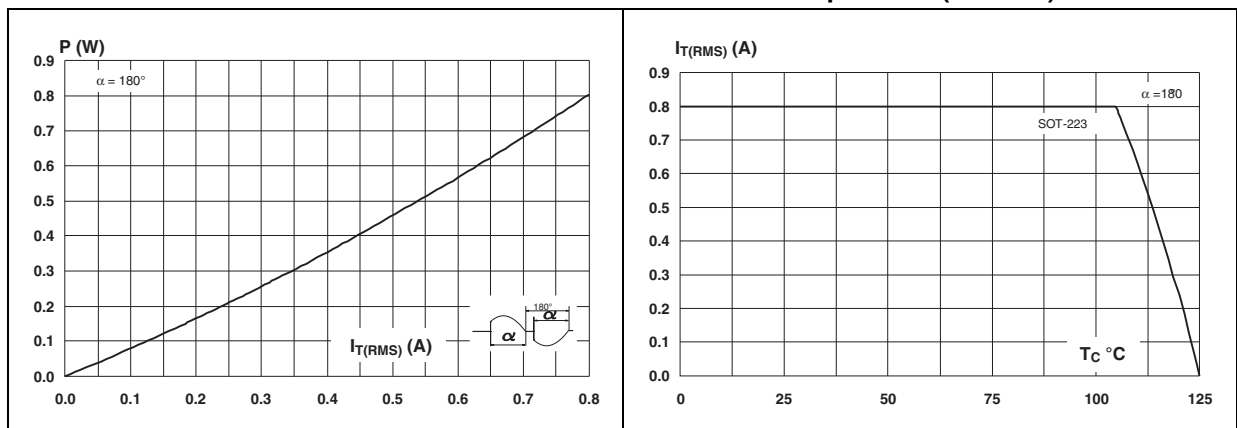

Figure 4. On-state rms current versus ambient temperature (free air convection)

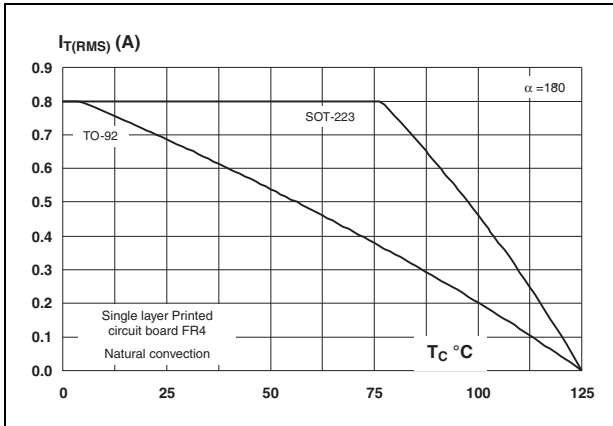

Figure 5. Relative variation of thermal impedance junction to ambient versus pulse duration

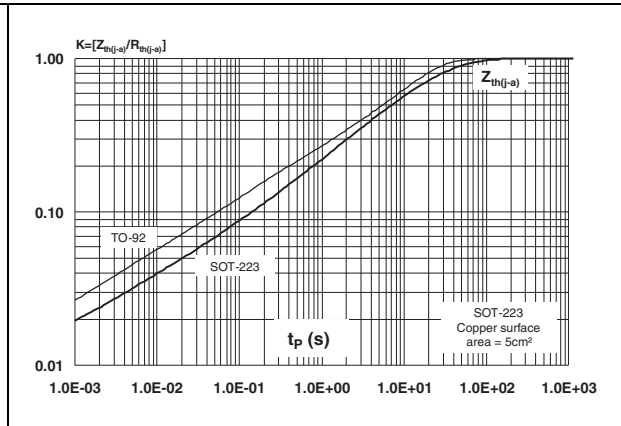

Figure 6. Relative variation of holding and latching current versus junction temperature

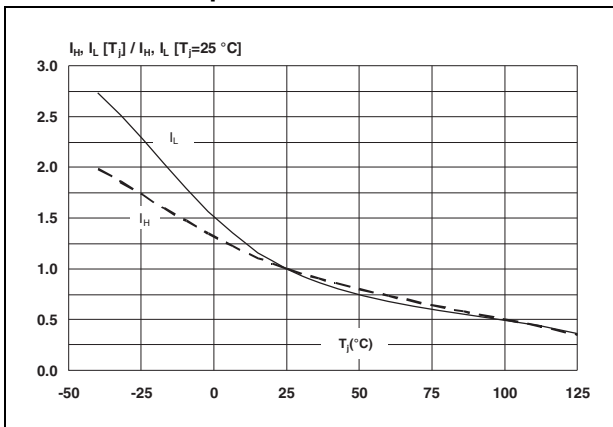

Figure 7. Relative variation of I_{GT} and V_{GT} versus junction temperature

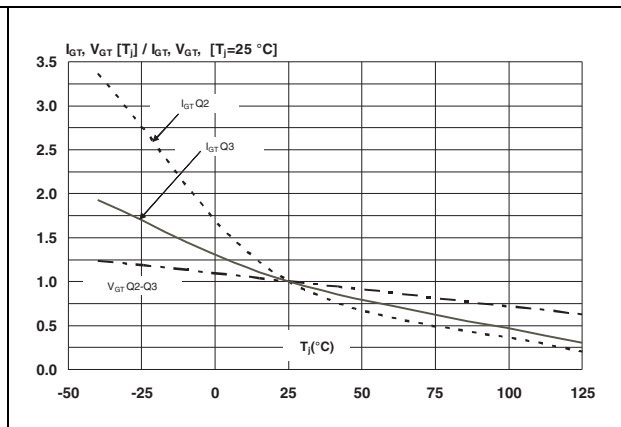

Figure 8. Surge peak on-state current versus number of cycles

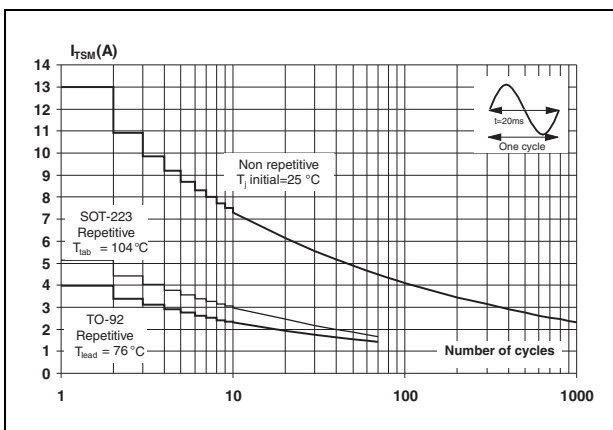

Figure 9. Non repetitive surge peak on-state current for a sinusoidal pulse, and corresponding value of I^2t

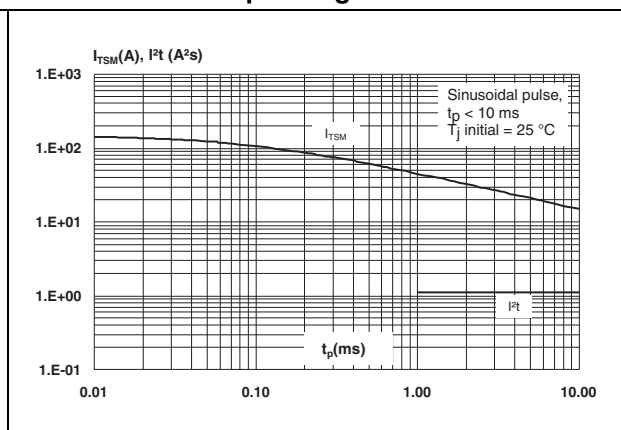

Figure 10. On-state characteristics (maximal values)

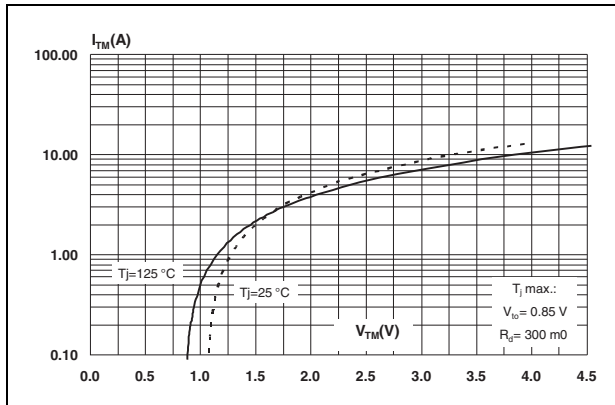

Figure 11. Relative variation of critical rate of decrease of main current versus junction temperature

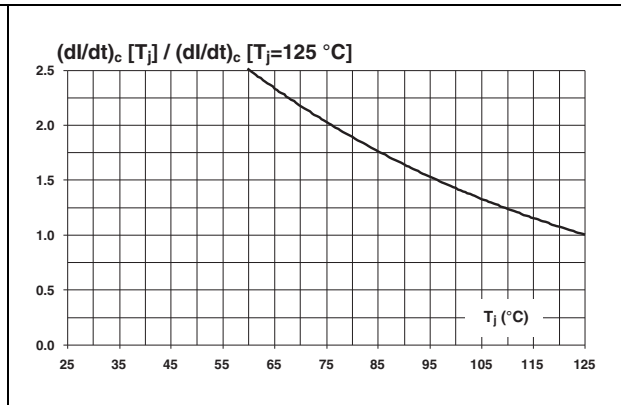

Figure 12. Relative variation of static dV/dt immunity versus junction temperature⁽¹⁾

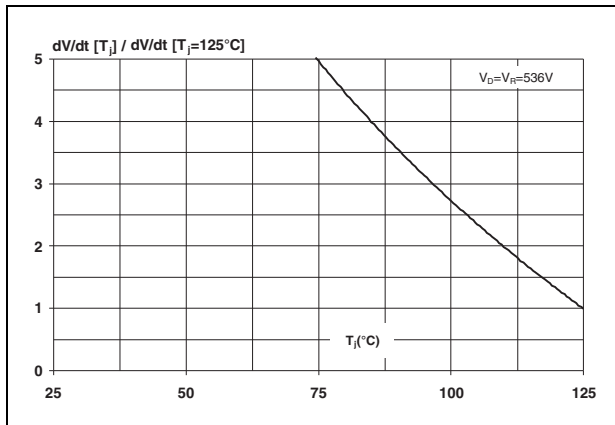
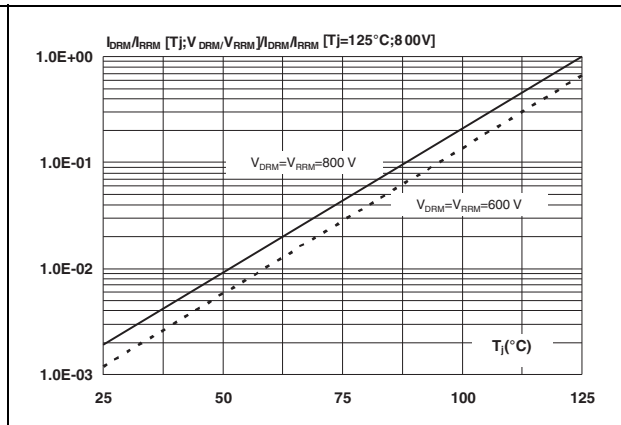

Figure 13. Relative variation of leakage current versus junction temperature



1. $V_D = V_R = 402 \text{ V}$: Typical values above $5 \text{ kV}/\mu\text{s}$. Beyond equipment capability

Figure 14. Relative variation of critical rate of decrease of main current (di/dt)_c versus (dV/dt)_c

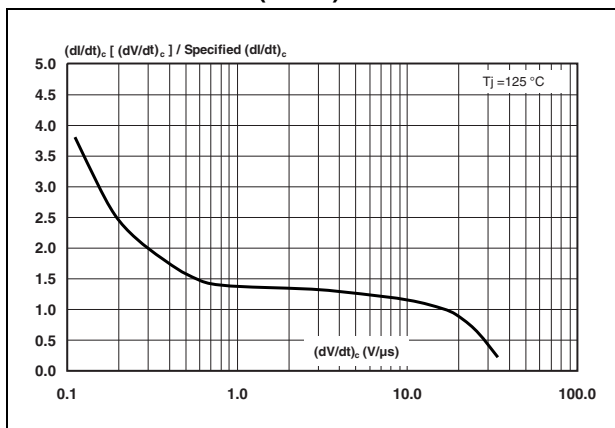
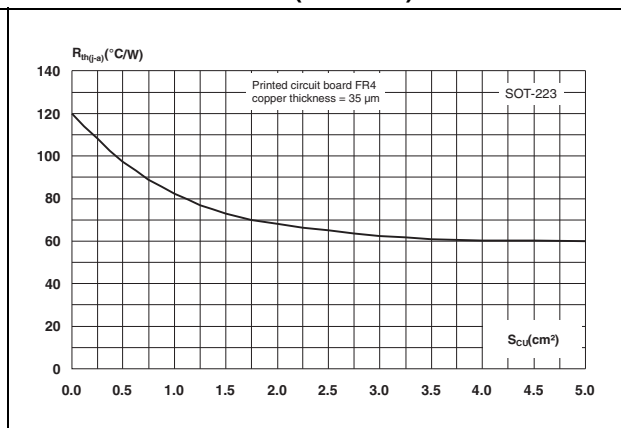

Figure 15. Thermal resistance junction to ambient versus copper surface under tab (SOT-223)



2 Alternating current mains switch - basic application

The ACS108 switch is triggered by a negative gate current flowing from the gate pin G. The switch can be driven directly by the digital controller through a resistor as shown in [Figure 16](#).

Thanks to its overvoltage protection and turn-off commutation performance, the ACS108 switch can drive a small power high inductive load with neither varistor nor additional turn-off snubber.

Figure 16. Typical application schematic

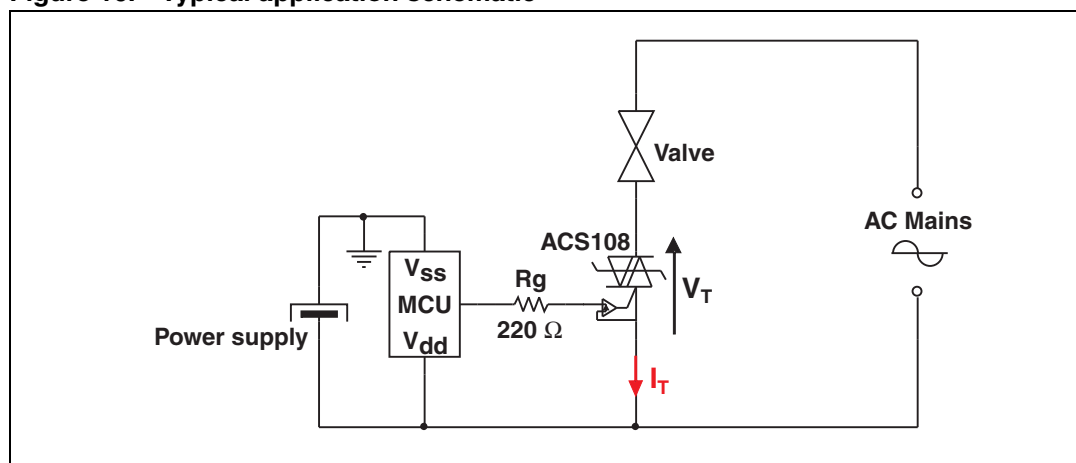

2.1 Protection against overvoltage: the best choice is ACS

In comparison with standard Triacs the ACS108 is over-voltage self-protected, as specified by the new parameter V_{CL} . This feature is useful in two operating conditions: in case of turn-off of very inductive load, and in case of surge voltage that can occur on the electrical network.

2.1.1 High inductive load switch-off: turn-off overvoltage clamping

With high inductive and low RMS current loads the rate of decrease of the current is very low. An overvoltage can occur when the gate current is removed and the OUT current is lower than I_H .

As shown in [Figure 17](#), at the end of the last conduction half-cycle, the load current decreases ①. The load current reaches the holding current level I_H ②, and the ACS turns off ③. The water valve, as an inductive load (up to 15 H), reacts as a current generator and an overvoltage is created, which is clamped by the ACS ④. The current flows through the ACS avalanche and decreases linearly to zero. During this time, the voltage across the switch is limited to the clamping voltage V_{CL} . The energy stored in the inductance of the load is dissipated in the clamping section that is designed for this purpose. When the energy has been dissipated, the ACS voltage falls back to the mains voltage value (230 V rms, 50 Hz) ⑤.

Figure 17. Switching off of a high inductive load - typical clamping capability of ACS108 ($T_{amb} = 25\text{ }^{\circ}\text{C}$)

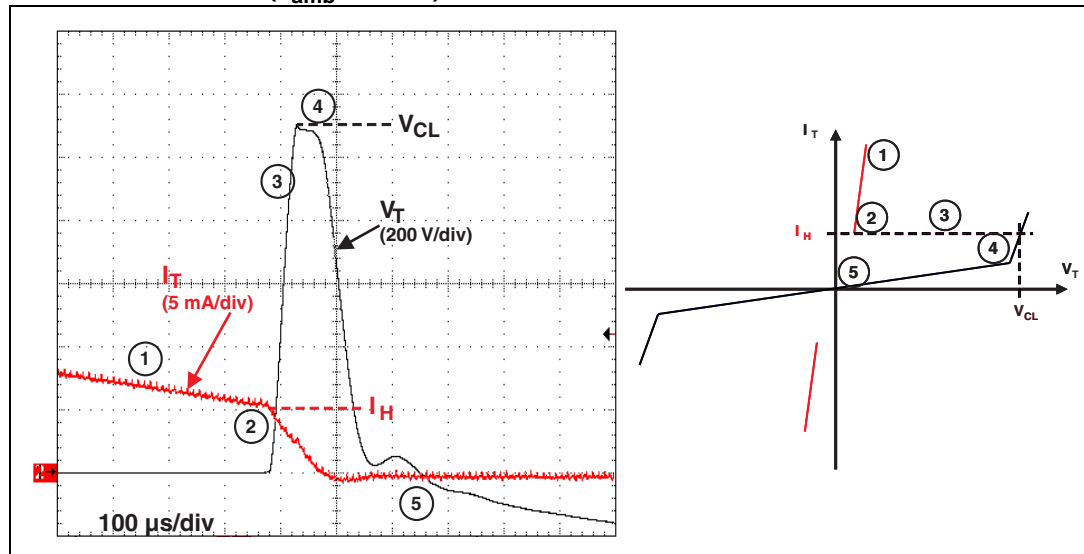

2.1.2 Alternating current mains transient voltage ruggedness

The ACS108 switch is able to withstand safely the AC mains transients either by clamping the low energy spikes or by breaking-over when subjected to high energy shocks, even with high turn-on current rises.

The test circuit shown in *Figure 18* is representative of the final ACS108 application, and is also used to test the AC switch according to the IEC 61000-4-5 standard conditions. Thanks to the load limiting the current, the ACS108 switch withstands the voltage spikes up to 2 kV above the peak mains voltage. The protection is based on an overvoltage crowbar technology. Actually, the ACS108 breaks over safely as shown in *Figure 19*. The ACS108 recovers its blocking voltage capability after the surge (switch off back at the next zero crossing of the current).

Such non-repetitive tests can be done 10 times on each AC mains voltage polarity.

Figure 18. Overvoltage ruggedness test circuit for resistive and inductive loads, $T_{amb} = 25\text{ }^{\circ}\text{C}$ (conditions equivalent to IEC 61000-4-5 standard)

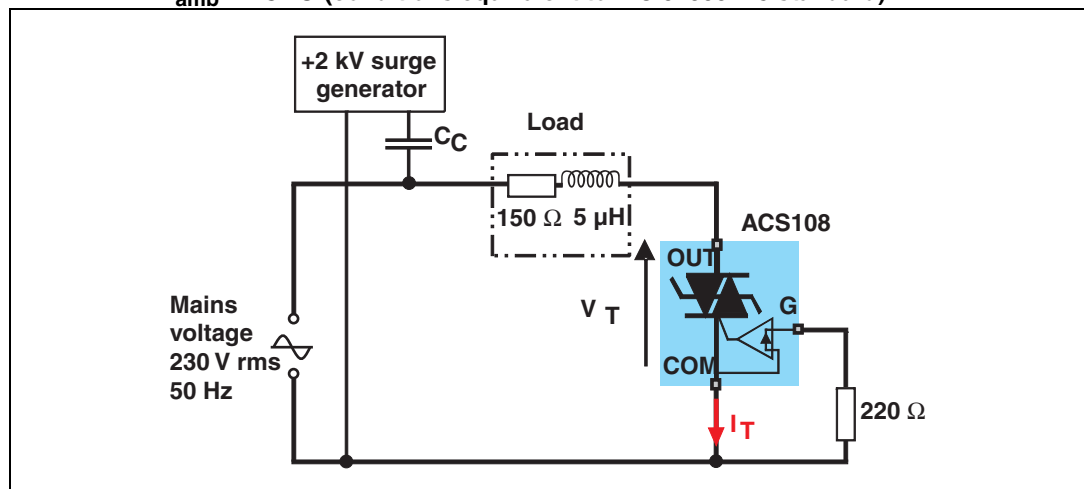
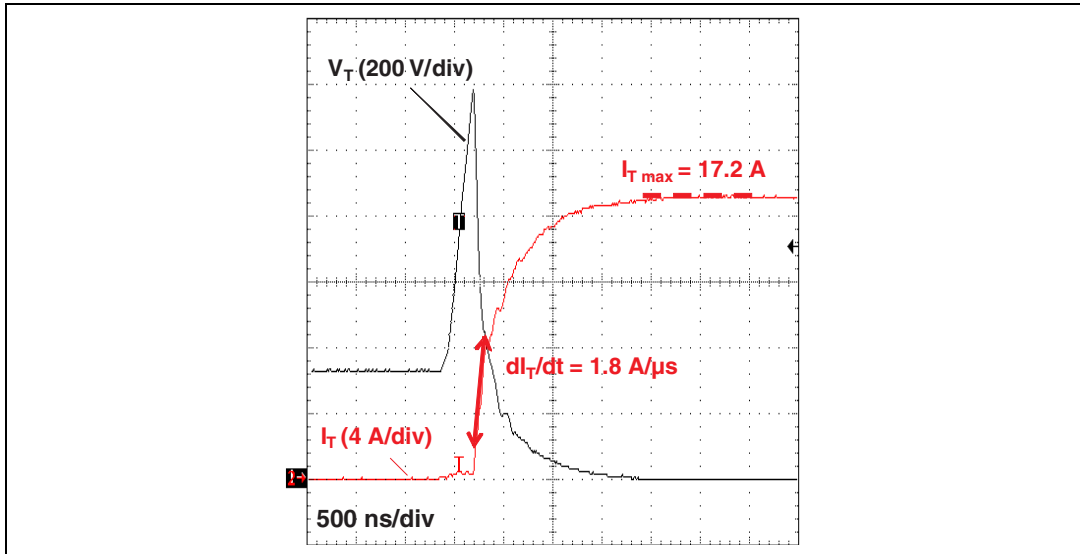
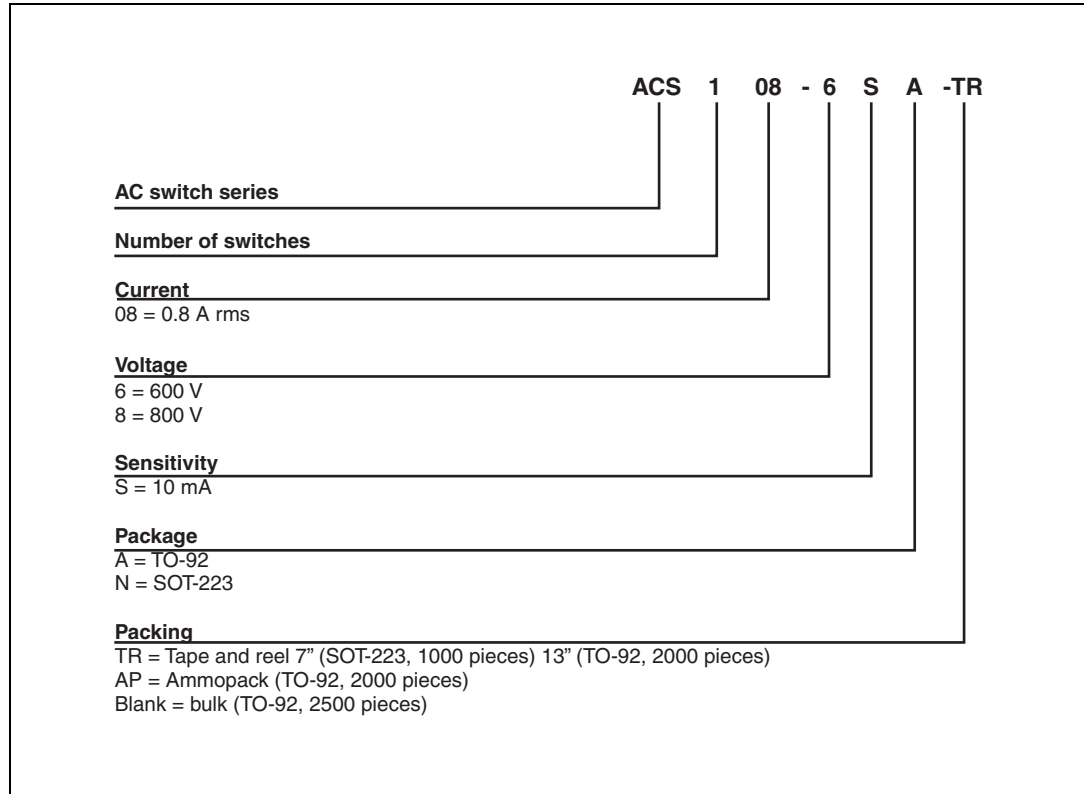

Figure 19. Typical current and voltage waveforms across the ACS108 (+2 kV surge, IEC 61000-4-5 standard)



3 Ordering information scheme

Figure 20. Ordering information scheme



4 Package information

- Epoxy meets UL94, V0
- Lead-free packages

In order to meet environmental requirements, ST offers these devices in different grades of ECOPACK® packages, depending on their level of environmental compliance. ECOPACK® specifications, grade definitions and product status are available at: www.st.com. ECOPACK® is an ST trademark.

Table 6. TO-92 dimensions

Ref	Dimensions					
	Millimeters			Inches		
	Min.	Typ.	Max.	Min.	Typ.	Max.
A		1.35			0.053	
B			4.70			0.185
C		2.54			0.100	
D	4.40			0.173		
E	12.70			0.500		
F			3.70			0.146
a			0.50			0.019

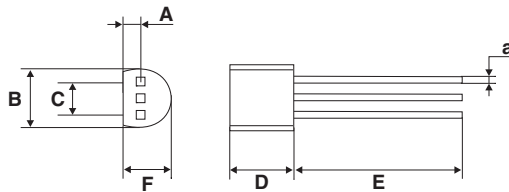
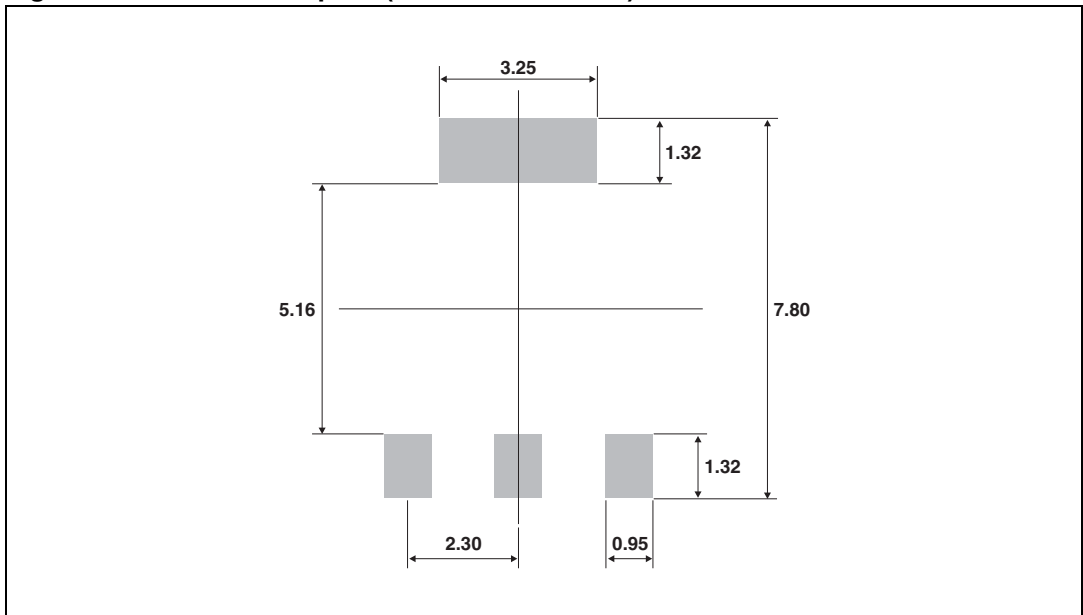

Table 7. SOT-223 dimensions

Ref.	Dimensions					
	Millimeters			Inches		
	Min.	Typ.	Max.	Min.	Typ.	Max.
A			1.80			0.071
A1		0.02	0.10		0.001	0.004
B	0.60	0.70	0.85	0.024	0.027	0.033
B1	2.90	3.00	3.15	0.114	0.118	0.124
c	0.24	0.26	0.35	0.009	0.010	0.014
D ⁽¹⁾	6.30	6.50	6.70	0.248	0.256	0.264
e		2.3			0.090	
e1		4.6			0.181	
E ⁽¹⁾	3.30	3.50	3.70	0.130	0.138	0.146
H	6.70	7.00	7.30	0.264	0.276	0.287
V	10° max					

1. Do not include mold flash or protrusions. Mold flash or protrusions shall not exceed 0.15mm (0.006inches)

Figure 21. SOT-223 footprint (dimensions in mm)



5 Ordering information

Table 8. Ordering information

Order code	Marking	Package	Weight	Base Qty	Delivery mode
ACS108-6SA	ACS1 086SA	TO-92	0.2 g	2500	Bulk
ACS108-6SA-TR		TO-92	0.2 g	2000	Tape and reel
ACS108-6SA-AP		TO-92	0.2 g	2000	Ammopack
ACS108-6SN-TR	ACS 108 6SN	SOT-223	0.11 g	1000	Tape and reel
ACS108-8SA	ACS1 088SA	TO-92	0.2 g	2500	Bulk
ACS108-8SA-TR		TO-92	0.2 g	2000	Tape and reel
ACS108-8SA-AP		TO-92	0.2 g	2000	Ammopack
ACS108-8SN-TR	ACS 108 8SN	SOT-223	0.11 g	1000	Tape and reel

6 Revision history

Table 9. Document revision history

Date	Revision	Changes
Apr_2004	1	Initial release. This datasheet covers order codes previously described in the datasheet for ACS108-6S, Doc ID 11962, Rev 3 December 2010.
21-Jun-2005	2	Marking information updated from ACSxxxx to ACS1xxx.
11-Jul-2012	3	Removed 500 V devices and added 600 V and 800 V devices.

Please Read Carefully:

Information in this document is provided solely in connection with ST products. STMicroelectronics NV and its subsidiaries ("ST") reserve the right to make changes, corrections, modifications or improvements, to this document, and the products and services described herein at any time, without notice.

All ST products are sold pursuant to ST's terms and conditions of sale.

Purchasers are solely responsible for the choice, selection and use of the ST products and services described herein, and ST assumes no liability whatsoever relating to the choice, selection or use of the ST products and services described herein.

No license, express or implied, by estoppel or otherwise, to any intellectual property rights is granted under this document. If any part of this document refers to any third party products or services it shall not be deemed a license grant by ST for the use of such third party products or services, or any intellectual property contained therein or considered as a warranty covering the use in any manner whatsoever of such third party products or services or any intellectual property contained therein.

UNLESS OTHERWISE SET FORTH IN ST'S TERMS AND CONDITIONS OF SALE ST DISCLAIMS ANY EXPRESS OR IMPLIED WARRANTY WITH RESPECT TO THE USE AND/OR SALE OF ST PRODUCTS INCLUDING WITHOUT LIMITATION IMPLIED WARRANTIES OF MERCHANTABILITY, FITNESS FOR A PARTICULAR PURPOSE (AND THEIR EQUIVALENTS UNDER THE LAWS OF ANY JURISDICTION), OR INFRINGEMENT OF ANY PATENT, COPYRIGHT OR OTHER INTELLECTUAL PROPERTY RIGHT.

UNLESS EXPRESSLY APPROVED IN WRITING BY TWO AUTHORIZED ST REPRESENTATIVES, ST PRODUCTS ARE NOT RECOMMENDED, AUTHORIZED OR WARRANTED FOR USE IN MILITARY, AIR CRAFT, SPACE, LIFE SAVING, OR LIFE SUSTAINING APPLICATIONS, NOR IN PRODUCTS OR SYSTEMS WHERE FAILURE OR MALFUNCTION MAY RESULT IN PERSONAL INJURY, DEATH, OR SEVERE PROPERTY OR ENVIRONMENTAL DAMAGE. ST PRODUCTS WHICH ARE NOT SPECIFIED AS "AUTOMOTIVE GRADE" MAY ONLY BE USED IN AUTOMOTIVE APPLICATIONS AT USER'S OWN RISK.

Resale of ST products with provisions different from the statements and/or technical features set forth in this document shall immediately void any warranty granted by ST for the ST product or service described herein and shall not create or extend in any manner whatsoever, any liability of ST.

ST and the ST logo are trademarks or registered trademarks of ST in various countries.

Information in this document supersedes and replaces all information previously supplied.

The ST logo is a registered trademark of STMicroelectronics. All other names are the property of their respective owners.

© 2012 STMicroelectronics - All rights reserved

STMicroelectronics group of companies

Australia - Belgium - Brazil - Canada - China - Czech Republic - Finland - France - Germany - Hong Kong - India - Israel - Italy - Japan - Malaysia - Malta - Morocco - Philippines - Singapore - Spain - Sweden - Switzerland - United Kingdom - United States of America

www.st.com

