

# AG303-86

## InGaP HBT Gain Block



### Product Features

- DC – 6000 MHz
- 20.5 dB Gain @ 900 MHz
- +14 dBm P1dB @ 900 MHz
- +26 dBm OIP3 @ 900 MHz
- Single Voltage Supply
- Internally matched to 50 Ω
- Robust 1000V ESD, Class 1C
- Lead-free/RoHS-compliant SOT-86 package

### Applications

- Mobile Infrastructure
- CATV / FTTX
- WLAN / ISM
- RFID
- WiMAX / WiBro

### Product Description

The AG303-86 is a general-purpose buffer amplifier that offers high dynamic range in a low-cost surface-mount package. At 900 MHz, the AG303-86 typically provides 20.5 dB gain, +26 dBm OIP3, and +14 dBm P1dB. The device combines dependable performance with consistent quality to maintain MTTF values exceeding 1000 years at mounting temperatures of +85 °C and is housed in a lead-free/RoHS-compliant SOT-86 (micro-X) industry-standard SMT package.

The AG303-86 consists of a Darlington-pair amplifier using the high reliability InGaP/GaAs HBT process technology and only requires DC-blocking capacitors, a bias resistor, and an inductive RF choke for operation.

The broadband MMIC amplifier can be directly applied to various current and next generation wireless technologies such as GPRS, GSM, CDMA, and W-CDMA. In addition, the AG303-86 will work for other various applications within the DC to 6 GHz frequency range such as CATV and WiMAX.

### Functional Diagram

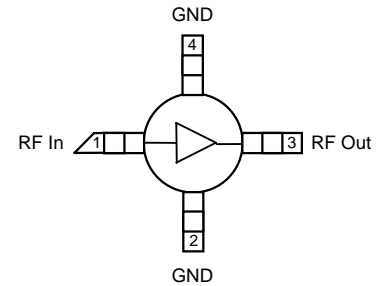

Function	Pin No.
Input	1
Output/Bias	3
Ground	2, 4

### Specifications <sup>(1)</sup>

Parameter	Units	Min	Typ	Max
Operational Bandwidth	MHz	DC		6000
Test Frequency	MHz		900	
Gain	dB		20.4	
Input Return Loss	dB		22	
Output Return Loss	dB		20	
Output P1dB	dBm		+14	
Output IP3 <sup>(2)</sup>	dBm		+26.1	
Output IP2	dBm		+34	
Noise Figure	dB		3	
Test Frequency	MHz		1900	
Gain	dB	16.9	18.1	18.9
Output P1dB	dBm		+12.7	
Output IP3 <sup>(2)</sup>	dBm		+24.8	
Device Voltage	V		4.23	
Device Current	mA		35	

1. Test conditions: T = 25 °C, Supply Voltage = +5 V, R<sub>bias</sub> = 22.1 Ω, 50 Ω System.  
 2. 3OIP measured with two tones at an output power of -2 dBm/tone separated by 10 MHz. The suppression on the largest IM3 product is used to calculate the 3OIP using a 2:1 rule.

### Typical Performance <sup>(1)</sup>

Parameter	Units	Typical			
Frequency	MHz	500	900	1900	2140
S21	dB	21.1	20.4	18.1	17.5
S11	dB	-21	-22	-26	-25
S22	dB	-22	-20	-16	-16
Output P1dB	dBm	+14.0	+14.0	+12.7	+12.4
Output IP3	dBm	+26.4	+26.1	+24.8	+24.4
Noise Figure	dB	2.9	3.0	3.2	3.2

### Absolute Maximum Rating

Parameter	Rating
Storage Temperature	-55 to +125 °C
DC Voltage	+5 V
RF Input Power (continuous)	+10 dBm
Thermal Resistance, R <sub>th</sub>	335°C/W
Junction Temperature	+177°C

Operation of this device above any of these parameters may cause permanent damage.

### Ordering Information

Part No.	Description
AG303-86G	InGaP HBT Gain Block (lead-free/RoHS-compliant SOT-86 Package)
AG303-86PCB	700 – 2400 MHz Fully Assembled Eval. Board

Standard tape / reel size = 3000 pieces on a 13" reel

### Typical Device RF Performance Supply Bias = +5 V, $R_{bias} = 22.1 \Omega$ , $I_{cc} = 35 \text{ mA}$

Frequency	MHz	100	500	900	1900	2140	2400	3500	5800
S21	dB	21.4	21.1	20.4	18.1	17.5	16.9	14.9	11.4
S11	dB	-25	-21	-22	-26	-25	-25	-25	-25
S22	dB	-19	-22	-20	-16	-16	-15	-15	-14
Output P1dB	dBm	+14.2	+14.0	+14.0	+12.7	+12.4	+12.1	+9.3	
Output IP3	dBm	+26.5	+26.4	+26.1	+24.8	+24.4	+23.9		
Noise Figure	dB	2.9	2.9	3.0	3.2	3.2	3.2		

1. Test conditions: T = 25 °C, Supply Voltage = +5 V, Device Voltage = 4.23 V,  $R_{bias} = 22.1 \Omega$ ,  $I_{cc} = 35 \text{ mA}$  typical, 50  $\Omega$  System.
2. 3OIP measured with two tones at an output power of -2 dBm/tone separated by 10 MHz. The suppression on the largest IM3 product is used to calculate the 3OIP using a 2:1 rule.
3. Data is shown as device performance only. Actual implementation for the desired frequency band will be determined by external components shown in the application circuit.

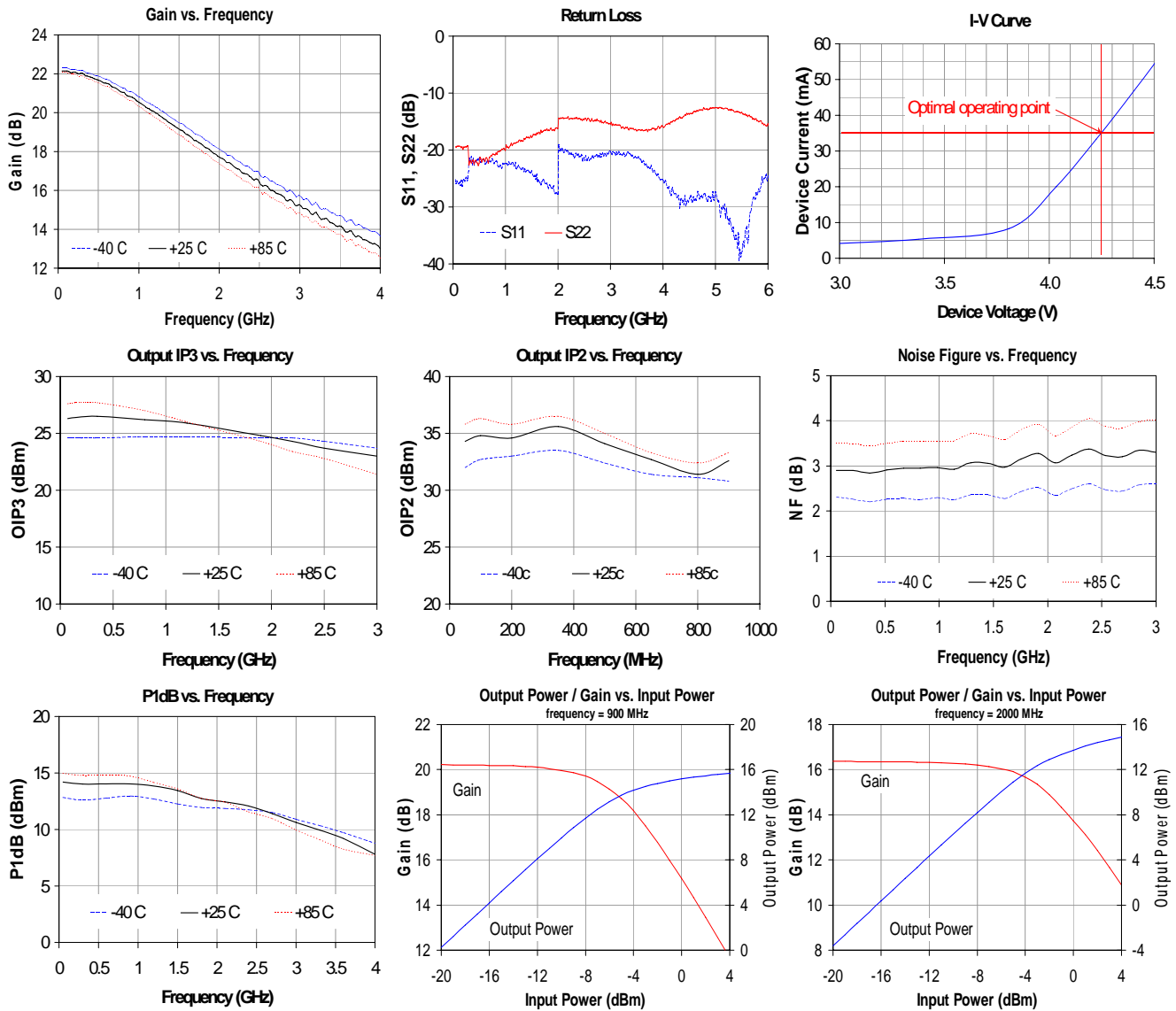

### Typical Device RF Performance (cont'd)

Supply Bias = +6 V,  $R_{bias} = 51 \Omega$ ,  $I_{cc} = 35 \text{ mA}$

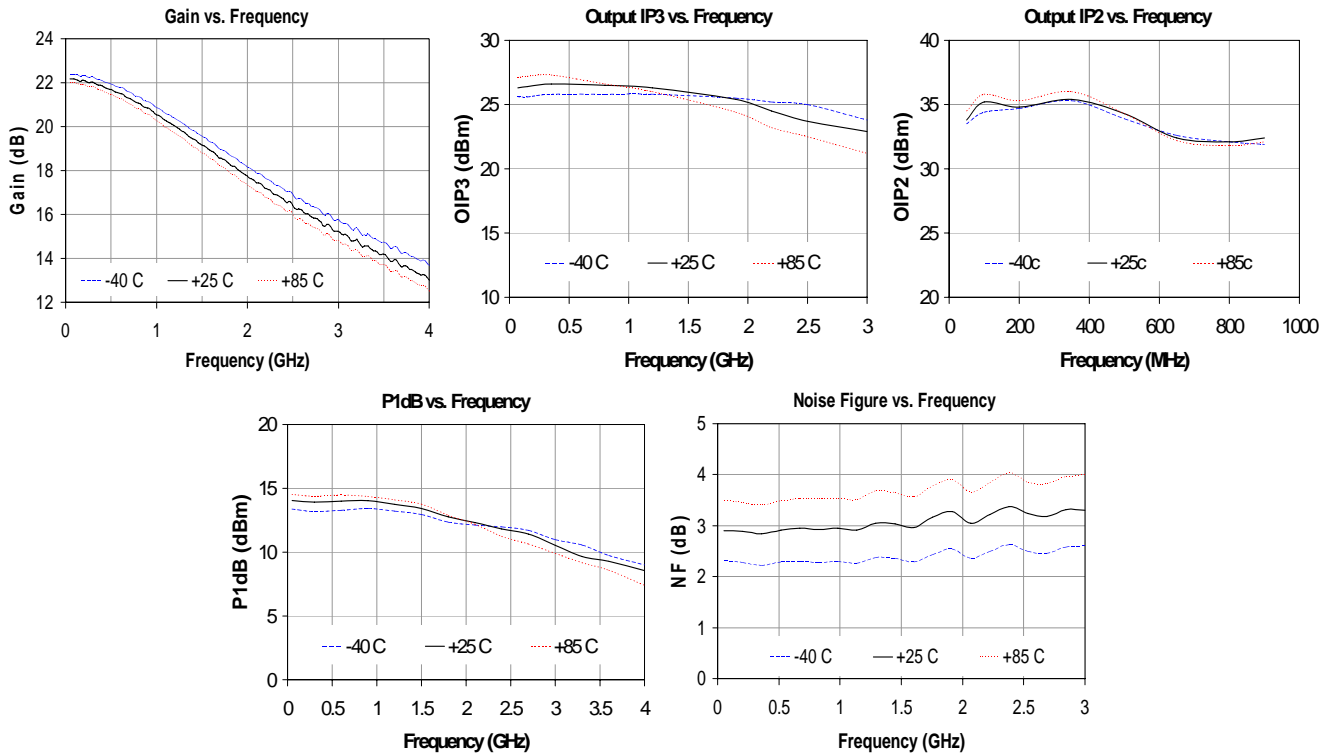

### Typical Device RF Performance

Supply Bias = +8 V,  $R_{bias} = 108 \Omega$ ,  $I_{cc} = 35 \text{ mA}$

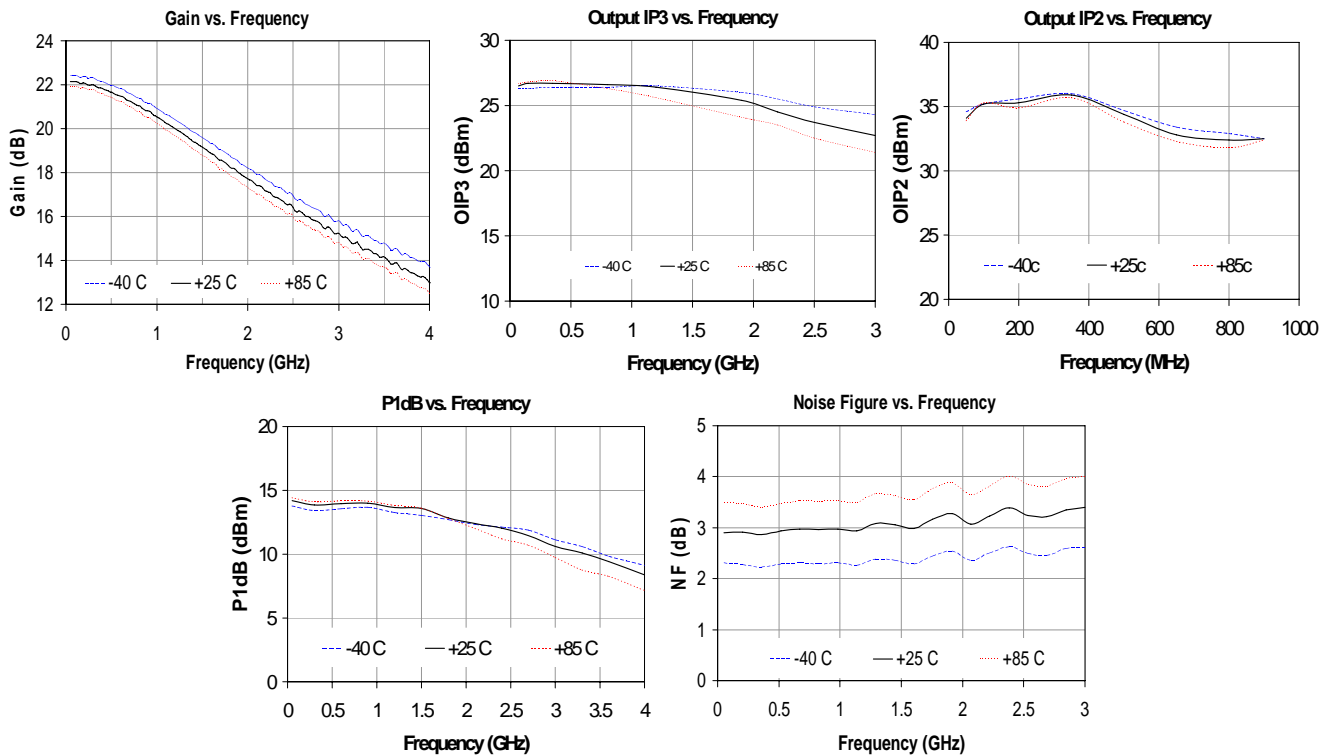

### Application Circuit

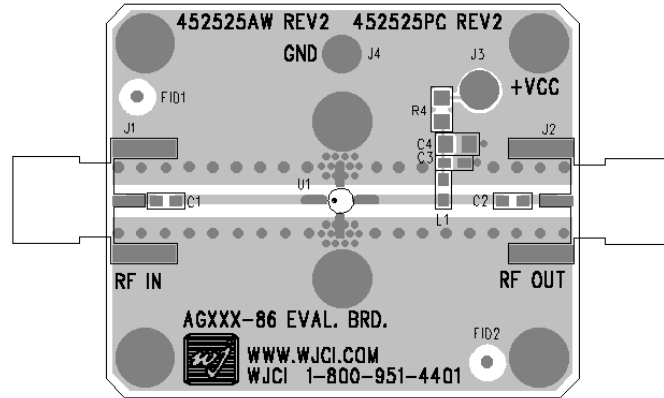
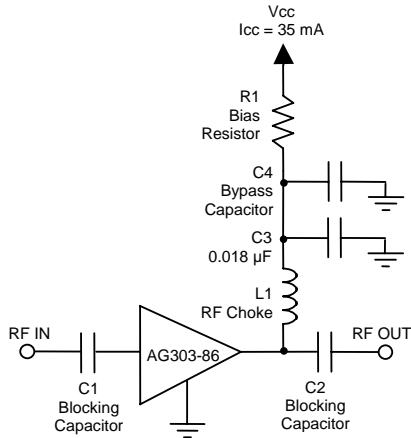

#### Recommended Component Values

Reference Designator	Frequency (MHz)						
	50	500	900	1900	2200	2500	3500
L1	820 nH	220 nH	68 nH	27 nH	22 nH	18 nH	15 nH
C1, C2, C4	.018 µF	1000 pF	100 pF	68 pF	68 pF	56 pF	39 pF

- The proper values for the components are dependent upon the intended frequency of operation.
- The following values are contained on the evaluation board to achieve optimal broadband performance:

Ref. Desig.	Value / Type	Size
L1	39 nH wirewound inductor	0603
C1, C2	56 pF chip capacitor	0603
C3	0.018 µF chip capacitor	0603
C4	Do Not Place	
R1	22.1 Ω 1% tolerance	0603

#### Recommended Bias Resistor Values

Supply Voltage	R1 value	Size
5 V	22.1 ohms	0603
6 V	51 ohms	0805
7 V	80 ohms	1206
8 V	108 ohms	1210
9 V	137 ohms	1210
10 V	166 ohms	1210
12 V	223 ohms	2010

The proper value for R1 is dependent upon the supply voltage and allows for bias stability over temperature. WJ recommends a minimum supply bias of +5 V. A 1% tolerance resistor is recommended.

### Typical Device Data

S-Parameters ( $V_{device} = +4.23$  V,  $I_{CC} = 35$  mA,  $T = 25$  °C, calibrated to device leads)

Freq (MHz)	S11 (dB)	S11 (ang)	S21 (dB)	S21 (ang)	S12 (dB)	S12 (ang)	S22 (dB)	S22 (ang)
50	-25.41	-178.61	21.90	177.08	-24.39	2.68	-19.43	-6.66
250	-24.87	155.73	21.78	166.27	-24.78	2.50	-19.45	-23.90
500	-21.45	140.47	21.52	152.92	-24.79	0.95	-22.15	-58.28
750	-21.60	121.87	21.11	140.36	-24.66	-0.65	-20.82	-83.69
1000	-22.37	104.08	20.62	128.55	-24.69	-0.47	-19.91	-103.53
1250	-22.85	90.28	20.09	117.05	-24.39	0.10	-18.42	-120.77
1500	-23.73	71.50	19.48	106.85	-23.69	0.62	-17.78	-130.98
1750	-25.75	49.04	18.90	96.96	-23.87	-1.60	-16.51	-140.18
2000	-25.80	20.48	18.25	87.61	-23.36	-1.98	-16.04	-146.19
2250	-20.60	4.51	17.68	79.42	-23.35	-1.35	-14.44	-135.98
2500	-21.35	-10.34	17.27	73.31	-23.42	-5.50	-14.66	-143.15
2750	-21.07	-27.85	16.73	64.91	-22.38	-6.48	-14.71	-151.02
3000	-20.28	-38.57	16.22	57.01	-22.30	-5.72	-15.40	-161.21
3250	-20.61	-43.39	15.75	49.56	-22.06	-7.56	-16.08	-172.88
3500	-21.43	-46.83	15.30	42.14	-21.79	-9.98	-16.63	172.37
3750	-23.21	-45.68	14.83	34.70	-21.14	-14.32	-16.45	152.74
4000	-25.23	-33.68	14.43	27.45	-21.01	-19.42	-15.95	135.04
4250	-27.97	-14.82	14.02	20.33	-20.54	-19.39	-14.63	121.85
4500	-28.62	21.21	13.56	13.29	-19.99	-23.59	-13.70	110.85
4750	-28.24	50.04	13.16	5.94	-19.74	-27.50	-12.98	104.47
5000	-27.40	61.17	12.84	-0.90	-19.45	-32.13	-12.53	101.02
5250	-32.61	78.84	12.46	-7.21	-19.53	-34.94	-12.98	97.98
5500	-38.22	144.81	12.12	-13.47	-19.19	-37.72	-13.34	99.21
5750	-28.58	-149.36	11.86	-19.80	-18.83	-41.09	-14.62	100.79
6000	-24.71	-137.35	11.61	-26.11	-18.61	-44.88	-15.38	100.73

Device S-parameters are available for download from the website at: <http://www.TriQuint.com>

### AG303-86G (Lead-free Sot-86 Package) Mechanical Information

This package is lead-free/RoHS-compliant. It is compatible with both lead-free (maximum 260 °C reflow temperature) and leaded (maximum 245 °C reflow temperature) soldering processes. The plating material on the pins is annealed matte tin over copper.

#### Outline Drawing

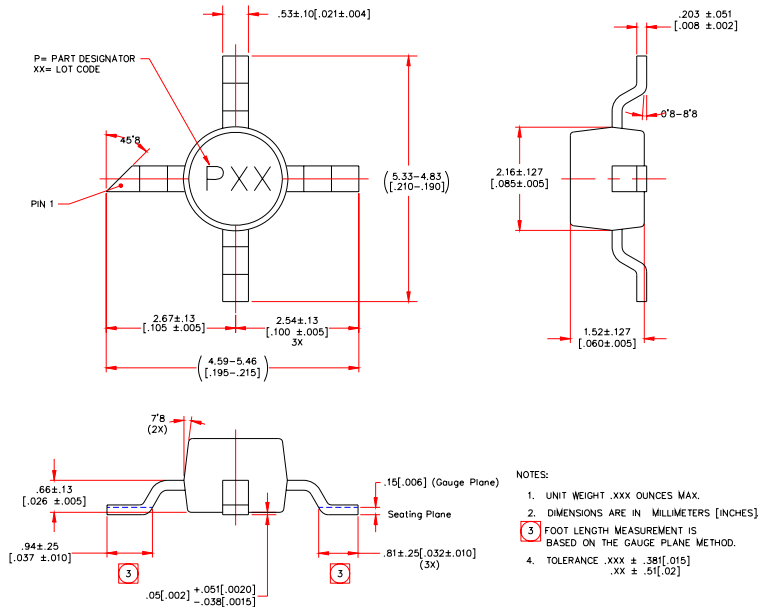

#### Land Pattern

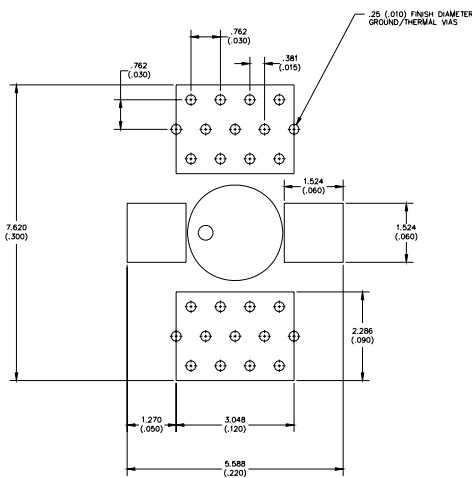

#### Product Marking

The component will be marked with a “P” designator followed by a two-digit numeric lot code on the top surface of the package. The obsolete tin-lead package is marked with an “E” designator followed by a two-digit numeric lot code.

Tape and reel specifications for this part are located on the website in the “Application Notes” section.

#### MSL / ESD Rating



**Caution!** ESD sensitive device.

**ESD Rating:** Class 1C  
**Value:** Passes ≥ 1000V min.  
**Test:** Human Body Model (HBM)  
**Standard:** JEDEC Standard JESD22-A114

**ESD Rating:** Class IV  
**Value:** Passes ≥ 1000V min.  
**Test:** Charged Device Model (CDM)  
**Standard:** JEDEC Standard JESD22-C101

**MSL Rating:** Level 3 at +260 °C convection reflow  
**Standard:** JEDEC Standard J-STD-020

#### Mounting Config. Notes

1. Ground / thermal vias are critical for the proper performance of this device. Vias should use a .35mm (#80 / .0135”) diameter drill and have a final plated thru diameter of .25 mm (.010”).
2. Add as much copper as possible to inner and outer layers near the part to ensure optimal thermal performance.
3. Mounting screws can be added near the part to fasten the board to a heatsink. Ensure that the ground / thermal via region contacts the heatsink.
4. Do not put solder mask on the backside of the PC board in the region where the board contacts the heatsink.
5. RF trace width depends upon the PC board material and construction.
6. Use 1 oz. Copper minimum.
7. All dimensions are in millimeters (inches). Angles are in degrees.