

P6SMBJ5.0 ... P6SMBJ170CA

Surface mount unidirectional and bidirectional Transient Voltage Suppressor Diodes
Unidirektionale und bidirektionale Spannungs-Begrenzer-Dioden für die Oberflächenmontage

Version 2009-05-22

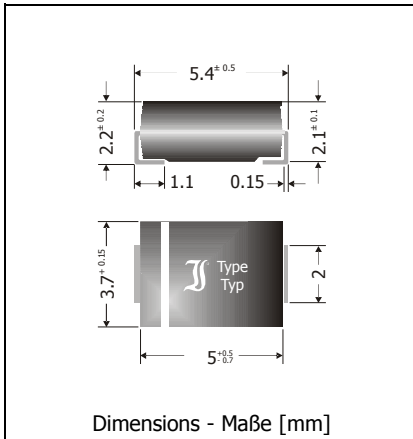

Peak pulse power dissipation Impuls-Verlustleistung	600 W
Nominal Stand-off voltage Nominale Sperrspannung	5.0...170 V
Plastic case Kunststoffgehäuse	~ SMB ~ DO-214AA
Weight approx. – Gewicht ca.	0.1 g
Plastic material has UL classification 94V-0 Gehäusematerial UL94V-0 klassifiziert	
Standard packaging taped and reeled Standard Lieferform gegurtet auf Rollen	



For bidirectional types, suppressor characteristics apply in both directions; add suffix "C" or "CA".
Für bidirektionale Dioden gelten die Begrenzer-Eigenschaften in beiden Richtungen;
es ist das Suffix "C" oder "CA" zu ergänzen.

**TVS diodes having breakdown voltage $V_{BR} = 220 \dots 550$ V:
please refer to datasheet P6SMB220 ... 550CA**
TVS-Dioden mit Abbruchspannung $V_{BR} = 220 \dots 550$ V: siehe Datenblatt P6SMB220 ... 550CA

Maximum ratings and Characteristics

Grenz- und Kennwerte

Peak pulse power dissipation (10/1000 μ s waveform) Impuls-Verlustleistung (Strom-Impuls 10/1000 μ s)	$T_A = 25^\circ\text{C}$	P_{PPM}	600 W ¹⁾
Steady state power dissipation Verlustleistung im Dauerbetrieb	$T_T = 75^\circ\text{C}$	$P_{M(AV)}$	5 W
Peak forward surge current, 60 Hz half sine-wave Stoßstrom für eine 60 Hz Sinus-Halbwellen	$T_A = 25^\circ\text{C}$	I_{FSM}	100 A ²⁾
Max. instantaneous forward voltage Augenblickswert der Durchlass-Spannung	$I_F = 25$ A	V_F	< 3.0 V ²⁾
Operating junction temperature – Sperrschichttemperatur		T_j	-50...+150°C
Storage temperature – Lagerungstemperatur		T_S	-50...+150°C
Thermal resistance junction to ambient air Wärmewiderstand Sperrschicht – umgebende Luft		R_{thA}	< 45 K/W ³⁾
Thermal resistance junction to terminal Wärmewiderstand Sperrschicht – Anschluss		R_{thT}	< 15 K/W

1 Non-repetitive pulse see curve $I_{pp} = f(t)$ / $P_{pp} = f(t)$

Höchstzulässiger Spitzenwert eines einmaligen Impulses, siehe Kurve $I_{pp} = f(t)$ / $P_{pp} = f(t)$

2 Unidirectional diodes only – Nur für unidirektionale Dioden

3 Mounted on P.C. board with 50 mm² copper pads at each terminal

Montage auf Leiterplatte mit 50 mm² Kupferbelag (Löt-pad) an jedem Anschluss

Maximum ratings				Grenzwerte		
Type Typ	Stand-off voltage Sperrspannung	Max. rev. current Max. Sperrstrom at / bei V_{WM}	Breakdown voltage at $I_T = 1$ mA Abbruch-Spannung bei $I_T = 1$ mA *) at / bei $I_T = 10$ mA		Max. clamping voltage Max. Begrenzer-Spannung at / bei I_{PPM} (10/1000 μ s)	
	V_{WM} [V]	I_D [μ A]	V_{BR} min [V]	V_{BR} max [V]	V_C [V]	I_{PPM} [A]
P6SMBJ5.0	5.0	800	6.4 *)	7.8 *)	10.3	58.3
P6SMBJ5.0A	5.0	800	6.4 *)	7.0 *)	9.2	65.2
P6SMBJ6.5	6.5	500	7.2 *)	8.8 *)	12.3	48.8
P6SMBJ6.5A	6.5	500	7.2 *)	8.0 *)	11.2	53.6
P6SMBJ7.0	7.0	200	7.8 *)	9.5 *)	13.3	45.1
P6SMBJ7.0A	7.0	200	7.8 *)	8.7 *)	12.0	50.0
P6SMBJ7.5	7.5	100	8.3	10.1	14.3	42.0
P6SMBJ7.5A	7.5	100	8.3	9.2	12.9	46.5
P6SMBJ8.0	8.0	50	8.9	10.9	15.0	40.0
P6SMBJ8.0A	8.0	50	8.9	9.9	13.6	44.1
P6SMBJ8.5	8.5	10	9.4	11.5	15.9	37.7
P6SMBJ8.5A	8.5	10	9.4	10.4	14.4	41.7
P6SMBJ9.0	9.0	5	10.0	12.2	16.9	35.5
P6SMBJ9.0A	9.0	5	10.0	11.1	15.4	39.0
P6SMBJ10	10	5	11.1	13.5	18.8	31.9
P6SMBJ10A	10	5	11.1	12.3	17.0	35.3
P6SMBJ11	11	5	12.2	14.9	20.1	29.9
P6SMBJ11A	11	5	12.2	13.5	18.2	33.0
P6SMBJ12	12	5	13.3	16.2	22.0	27.3
P6SMBJ12A	12	5	13.3	14.8	19.9	30.2
P6SMBJ13	13	5	14.4	17.6	23.8	25.2
P6SMBJ13A	13	5	14.4	16.0	21.5	27.9
P6SMBJ14	14	5	15.6	19.0	25.8	23.3
P6SMBJ14A	14	5	15.6	17.3	23.2	25.9
P6SMBJ15	15	5	16.7	20.4	26.9	22.3
P6SMBJ15A	15	5	16.7	18.6	24.4	24.6
P6SMBJ16	16	5	17.8	21.7	28.8	20.8
P6SMBJ16A	16	5	17.8	19.8	26.0	23.1
P6SMBJ17	17	5	18.9	23.1	30.5	19.7
P6SMBJ17A	17	5	18.9	21.0	27.6	21.7
P6SMBJ18	18	5	20.0	24.4	32.2	18.6
P6SMBJ18A	18	5	20.0	22.2	29.2	20.5
P6SMBJ20	20	5	22.2	27.1	35.8	16.8
P6SMBJ20A	20	5	22.2	24.6	32.4	18.5
P6SMBJ22	22	5	24.4	29.8	39.4	15.2
P6SMBJ22A	22	5	24.4	27.1	35.5	16.9
P6SMBJ24	24	5	26.7	32.6	43.0	14.0
P6SMBJ24A	24	5	26.7	29.6	38.9	15.4
P6SMBJ26	26	5	28.9	35.3	46.6	12.9
P6SMBJ26A	26	5	28.9	32.1	42.1	14.3
P6SMBJ28	28	5	31.1	37.9	50.0	12.0
P6SMBJ28A	28	5	31.1	34.5	45.4	13.2
P6SMBJ30	30	5	33.3	40.1	53.5	11.2
P6SMBJ30A	30	5	33.3	36.9	48.4	12.4
P6SMBJ33	33	5	36.7	44.8	59.0	10.2
P6SMBJ33A	33	5	36.7	40.7	53.3	11.3

Maximum ratings				Grenzwerte		
Type Typ	Stand-off voltage Sperrspannung	Max. rev. current Max. Sperrstrom at / bei V_{WM}	Breakdown voltage at $I_T = 1$ mA Abbruch-Spannung bei $I_T = 1$ mA) at / bei $I_T = 10$ mA		Max. clamping voltage Max. Begrenzer-Spannung at / bei I_{PPM} (10/1000 μ s)	
	V_{WM} [V]	I_D [μ A]	V_{BR} min [V]	V_{BR} max [V]	V_C [V]	I_{PPM} [A]
P6SMBJ36	36	5	40.0	48.4	64.3	9.3
P6SMBJ36A	36	5	40.0	44.4	58.1	10.3
P6SMBJ40	40	5	44.4	54.2	71.4	8.4
P6SMBJ40A	40	5	44.4	49.3	64.5	9.3
P6SMBJ43	43	5	47.8	58.3	76.7	7.8
P6SMBJ43A	43	5	47.8	53.1	69.4	8.6
P6SMBJ45	45	5	50.0	61.0	80.3	7.5
P6SMBJ45A	45	5	50.0	55.5	72.7	8.3
P6SMBJ48	48	5	53.3	65.0	85.5	7.0
P6SMBJ48A	48	5	53.3	59.2	77.4	7.8
P6SMBJ51	51	5	56.7	69.2	91.1	6.6
P6SMBJ51A	51	5	56.7	62.9	82.4	7.3
P6SMBJ54	54	5	60.0	73.2	96.3	6.2
P6SMBJ54A	54	5	60.0	66.6	87.1	6.9
P6SMBJ58	58	5	64.4	78.6	103	5.8
P6SMBJ58A	58	5	64.4	71.5	93.6	6.4
P6SMBJ60	60	5	66.7	81.4	107	5.6
P6SMBJ60A	60	5	66.7	74.0	96.8	6.2
P6SMBJ64	64	5	71.1	86.7	114	5.3
P6SMBJ64A	64	5	71.1	78.9	103	5.8
P6SMBJ70	70	5	77.8	94.9	125	4.8
P6SMBJ70A	70	5	77.8	86.4	113	5.3
P6SMBJ75	75	5	83.3	102	134	4.5
P6SMBJ75A	75	5	83.3	92.5	121	5.0
P6SMBJ78	78	5	86.7	106	139	4.3
P6SMBJ78A	78	5	86.7	96.2	126	4.8
P6SMBJ85	85	5	94.4	115	151	4.0
P6SMBJ85A	85	5	94.4	105	137	4.4
P6SMBJ90	90	5	100	122	160	3.8
P6SMBJ90A	90	5	100	111	146	4.1
P6SMBJ100	100	5	111	135	179	3.4
P6SMBJ100A	100	5	111	123	162	3.7
P6SMBJ110	110	5	122	149	196	3.1
P6SMBJ110A	110	5	122	135	177	3.4
P6SMBJ120	120	5	133	162	214	2.8
P6SMBJ120A	120	5	133	148	193	3.1
P6SMBJ130	130	5	144	176	231	2.6
P6SMBJ130A	130	5	144	160	209	2.9
P6SMBJ150	150	5	167	204	268	2.2
P6SMBJ150A	150	5	167	185	243	2.5
P6SMBJ160	160	5	178	217	287	2.1
P6SMBJ160A	160	5	178	198	259	2.3
P6SMBJ170	170	5	189	231	304	2.0
P6SMBJ170A	170	5	189	210	275	2.2

TVS diodes having breakdown voltage $V_{BR} = 220 \dots 550$ V: please refer to datasheet P6SMB220 ... 550CA
TVS-Dioden mit Abbruchspannung $V_{BR} = 220 \dots 550$ V: siehe Datenblatt P6SMB220 ... 550CA

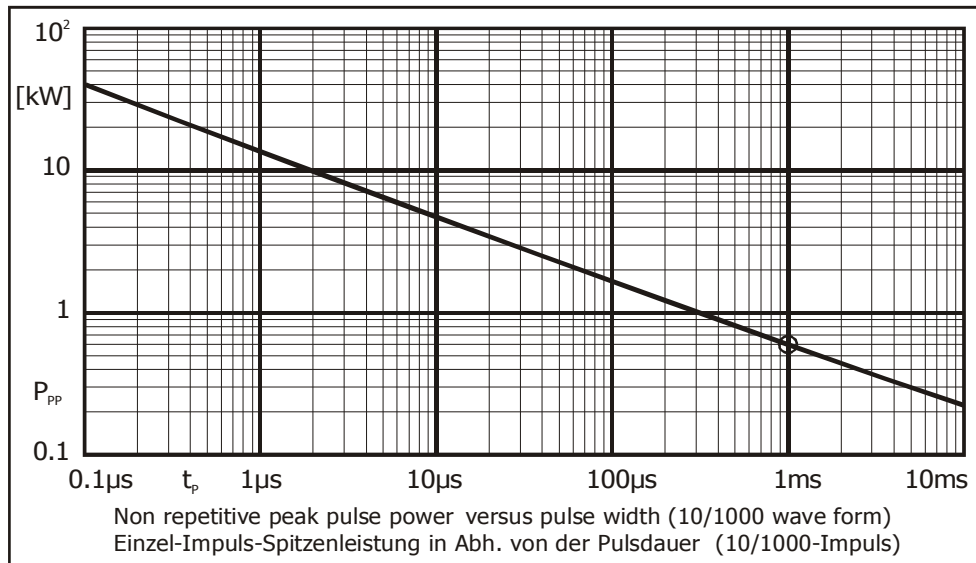
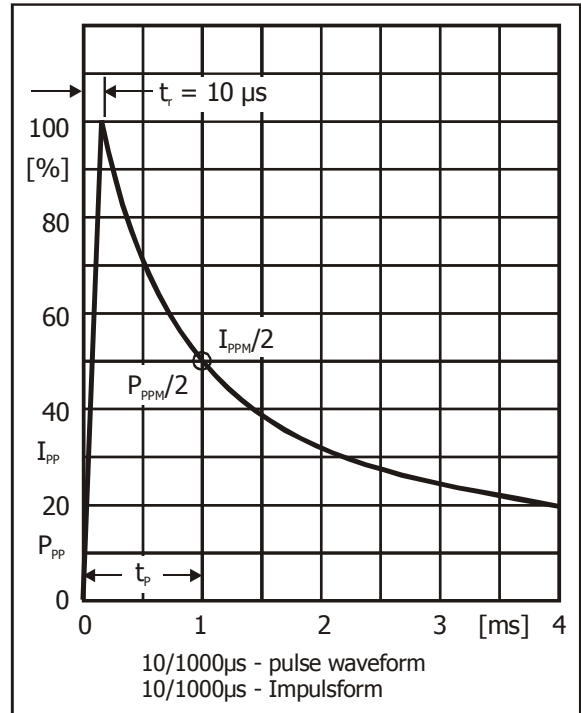
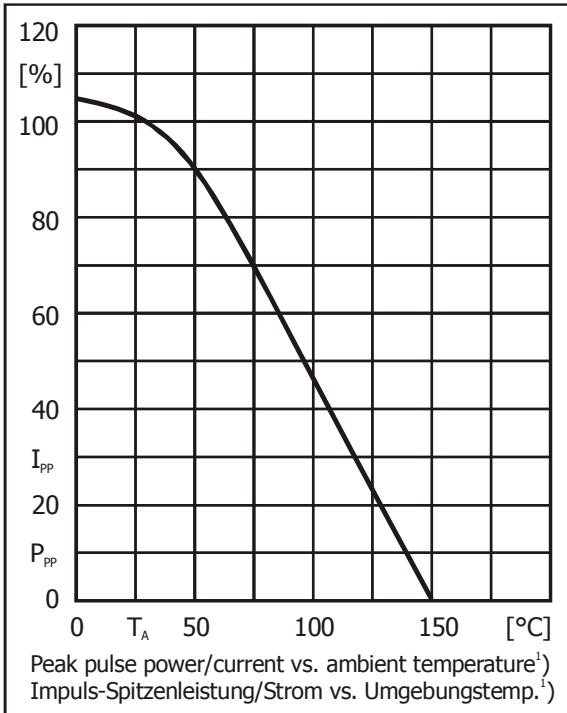

1 Mounted on P.C. board with 50 mm² copper pads at each terminal
Montage auf Leiterplatte mit 50 mm² Kupferbelag (Lötpad) an jedem Anschluss