

ZF/ZFW CONNECTOR

1.5mm pitch/Disconnectable Insulation displacement connectors

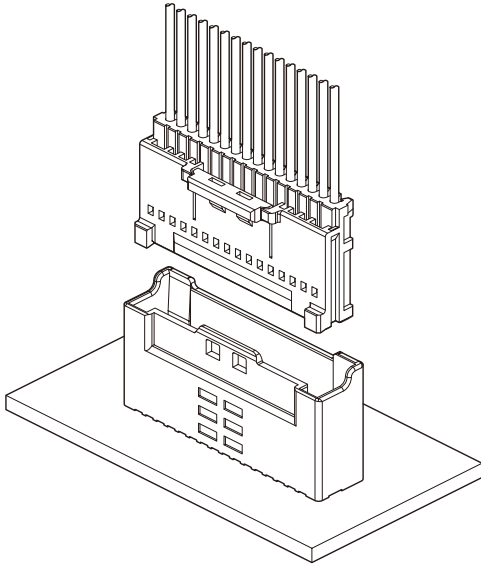

This is a 1.5mm pitch secure lock type board-to-wire/insulation displacement connector for the first time in the industry, having the bearing force to unusual external force.

- Twin U-slot insulation displacement section
- Superior operability (Low insertion force)
- Strain relief
- Secure locking structure

Specifications

- Current rating: 0.7A AC, DC (AWG#28)
- Voltage rating: 50V AC, DC
- Temperature range: -25°C to +85°C
(including temperature rise in applying electrical current)
- Contact resistance: Initial value/20m Ω max.
After environmental testing/40m Ω max.
- Insulation resistance: 500M Ω min.
- Withstanding voltage: 500V AC/minute
- Applicable wire: Conductor size/UL10272 AWG#28
Insulation O.D./0.78mm
- Applicable PC board thickness: 1.6mm
- * Compliant with RoHS.
- * Refer to "General Instruction and Notice when using Terminals and Connectors" at the end of this catalog.
- * Contact JST for details.

PC board layout (viewed from component side) and Assembly layout

Top entry type

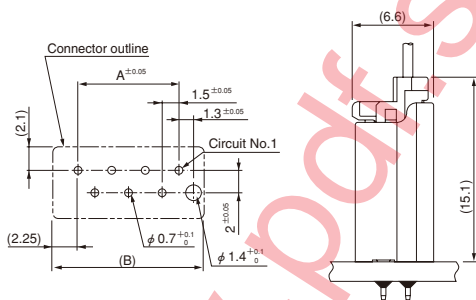

Double-row type

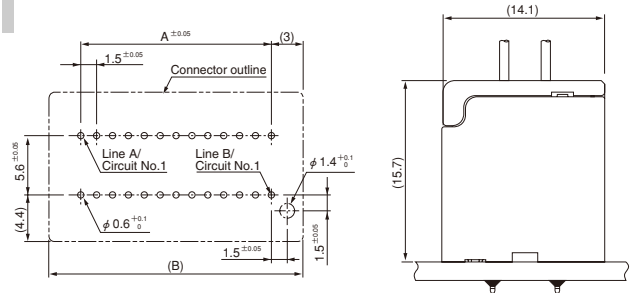

Side entry type

(2 to 5 circuits)

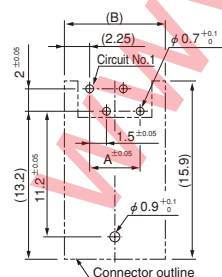

(6 to 20 circuits)

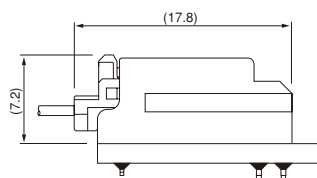
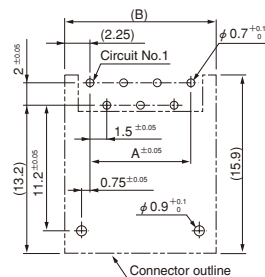

Note: 1. Tolerances are non-cumulative: ±0.05mm for all centers.
2. Hole dimensions differ according to the kind of PC board and piercing method.
The dimensions above should serve as a guideline. Contact JST for details.

ZF/ZFW CONNECTOR

Socket

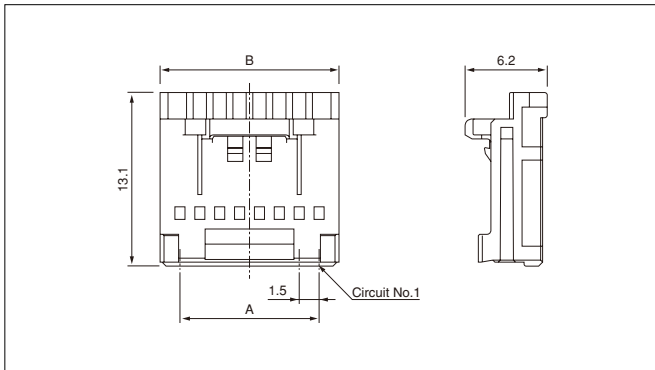

Circuits	Model No.	Dimensions (mm)		Q'ty / box
		A	B	
2	02ZF-6S-P	—	4.5	1,000
3	03ZF-6S-P	3.0	6.0	1,000
4	04ZF-6S-P	4.5	7.5	500
5	05ZF-6S-P	6.0	9.0	500
6	06ZF-6S-P	7.5	10.5	500
7	07ZF-6S-P	9.0	12.0	500
8	08ZF-6S-P	10.5	13.5	500
9	09ZF-6S-P	12.0	15.0	500
10	10ZF-6S-P	13.5	16.5	500
11	11ZF-6S-P	15.0	18.0	250
12	12ZF-6S-P	16.5	19.5	250
13	13ZF-6S-P	18.0	21.0	250
14	14ZF-6S-P	19.5	22.5	250
15	15ZF-6S-P	21.0	24.0	250
16	16ZF-6S-P	22.5	25.5	250
17	17ZF-6S-P	24.0	27.0	250
18	18ZF-6S-P	25.5	28.5	250
19	19ZF-6S-P	27.0	30.0	200
20	20ZF-6S-P	28.5	31.5	200

Material and Finish

Contact: Copper alloy, copper-undercoated, tin-plated (reflow treatment)
Housing: Glass-filled PA 66, UL94V-0, natural (ivory)

RoHS compliance

ZF connector shrouded header

Top entry type

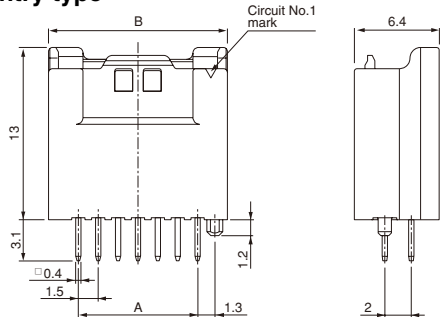

Side entry type

<2 to 5 circuits>

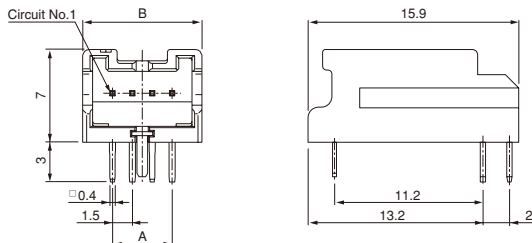

<6 to 20 circuits>

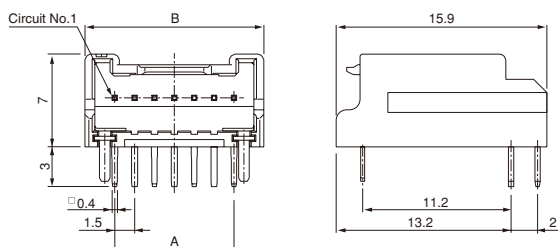

Circuits	Model No.		Dimensions (mm)		Q'ty / box	
	Top entry type	Side entry type	A	B	Top entry type	Side entry type
2	B02B-ZFSS-1	S02B-ZFSS-2	—	6.0	8,400	4,800
3	B03B-ZFSS-1	S03B-ZFSS-2	3.0	7.5	6,720	3,840
4	B04B-ZFSS-1	S04B-ZFSS-2	4.5	9.0	5,544	3,168
5	B05B-ZFSS-1	S05B-ZFSS-2	6.0	10.5	4,704	2,688
6	B06B-ZFSS-1	S06B-ZFSS-2	7.5	12.0	4,200	2,400
7	B07B-ZFSS-1	S07B-ZFSS-2	9.0	13.5	3,696	2,112
8	B08B-ZFSS-1	S08B-ZFSS-2	10.5	15.0	3,360	1,920
9	B09B-ZFSS-1	S09B-ZFSS-2	12.0	16.5	3,024	1,728
10	B10B-ZFSS-1	S10B-ZFSS-2	13.5	18.0	2,688	1,536
11	B11B-ZFSS-1	S11B-ZFSS-2	15.0	19.5	2,520	1,440
12	B12B-ZFSS-1	S12B-ZFSS-2	16.5	21.0	2,352	1,344
13	B13B-ZFSS-1	S13B-ZFSS-2	18.0	22.5	2,184	1,248
14	B14B-ZFSS-1	S14B-ZFSS-2	19.5	24.0	2,016	1,152
15	B15B-ZFSS-1	S15B-ZFSS-2	21.0	25.5	1,848	1,056
16	B16B-ZFSS-1	S16B-ZFSS-2	22.5	27.0	1,848	1,056
17	B17B-ZFSS-1	S17B-ZFSS-2	24.0	28.5	1,680	960
18	B18B-ZFSS-1	S18B-ZFSS-2	25.5	30.0	1,680	960
19	B19B-ZFSS-1	S19B-ZFSS-2	27.0	31.5	1,512	864
20	B20B-ZFSS-1	S20B-ZFSS-2	28.5	33.0	1,512	864

Material and Finish

Post: Copper alloy, copper-undercoated, tin-plated (reflow treatment)
Wafer: Glass-filled PA 66, UL94V-0, natural (ivory)
Reinforcement: Copper alloy, tin-plated (reflow treatment)

RoHS compliance This product displays (LF)(SN) on a label.

<For reference> As the color identification, the following alphabet shall be put in the underlined part. For availability, delivery and minimum order quantity, contact JST.

ex. **B02B-ZFSS-1**

S...natural (ivory) K...black R...red E...blue MG...moss green

ZF/ZFW CONNECTOR

ZFW connector Double-row shrouded header

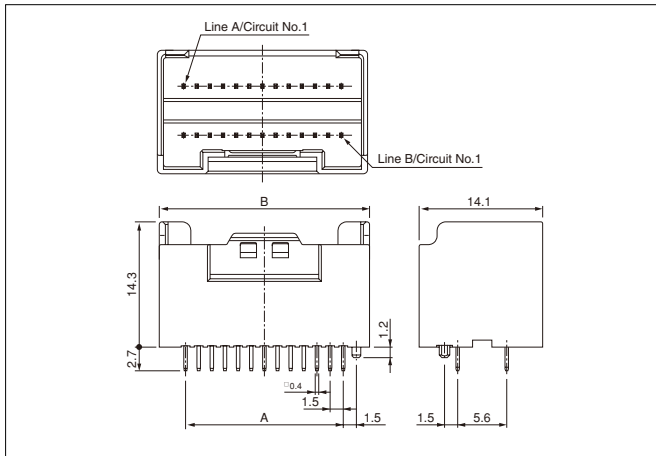

Circuits	Model No.	Dimensions (mm)		Q'ty / box
		A	B	
18	B18B-ZFWKS-1	12.0	18.0	1,008
22	B22B-ZFWKS-1	15.0	21.0	882
26	B26B-ZFWKS-1	18.0	24.0	756
30	B30B-ZFWKS-1	21.0	27.0	693
34	B34B-ZFWKS-1	24.0	30.0	630
38	B38B-ZFWKS-1	27.0	33.0	567
40	B40B-ZFWKS-1	28.5	34.5	504

Material and Finish

Post: Copper alloy, copper-undercoated, tin-plated (reflow treatment)
Wafer: Glass-filled PA 66, UL94V-0, black

RoHS compliance This product displays (LF)(SN) on a label.

ZFW connector holder

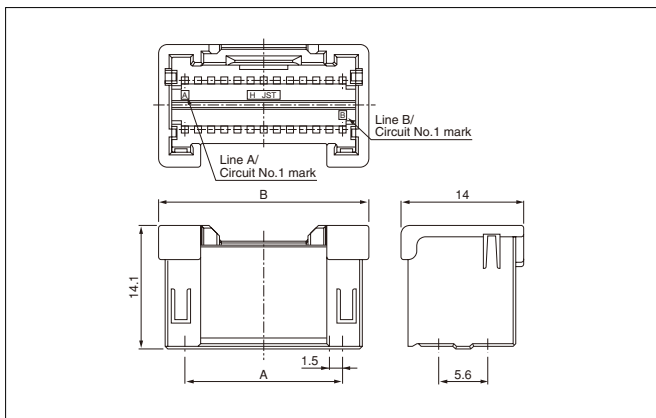

Circuits	Model No.	Dimensions (mm)		Q'ty / bag
		A	B	
18	ZFWH-18-K	12.0	18.0	300
22	ZFWH-22-K	15.0	21.0	300
26	ZFWH-26-K	18.0	24.0	250
30	ZFWH-30-K	21.0	27.0	150
34	ZFWH-34-K	24.0	30.0	150
38	ZFWH-38-K	27.0	33.0	100
40	ZFWH-40-K	28.5	34.5	100

Material

PBT, UL94V-0, black

RoHS compliance