



H11B1X, H11B2X, H11B3X
H11B1, H11B2, H11B3

OPTICALLY COUPLED ISOLATOR PHOTODARLINGTON OUTPUT



APPROVALS

- UL recognised, File No. E91231
- 'X' SPECIFICATION APPROVALS
 - VDE 0884 in 2 available lead form :
 - STD
 - G form
 - VDE 0884 in SMD approval pending
 - SETI approved, reg. no.151786-18

DESCRIPTION

The H11B_ series of optically coupled isolators consist of an infrared light emitting diode and NPN silicon photodarlington in a space efficient dual in line plastic package.

FEATURES

- Options :-
 - 10mm lead spread - add G after part no.
 - Surface mount - add SM after part no.
 - Tape&reel - add SMT&R after part no.
- High Current Transfer Ratio
- High Isolation Voltage (5.3kV_{RMS}, 7.5kV_{PK})
- All electrical parameters 100% tested
- Custom electrical selections available

APPLICATIONS

- Computer terminals
- Industrial systems controllers
- Measuring instruments
- Signal transmission between systems of different potentials and impedances

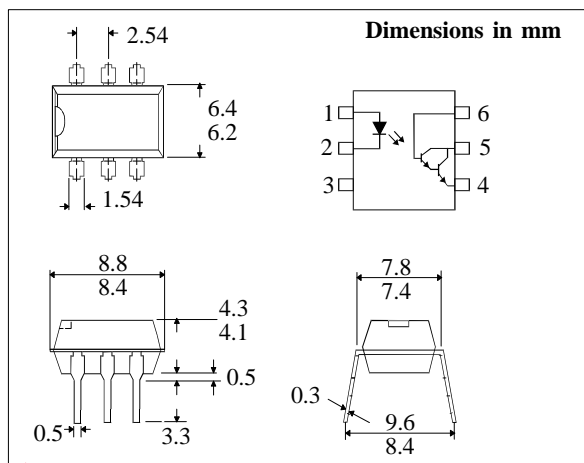

ABSOLUTE MAXIMUM RATINGS (25°C unless otherwise specified)

Storage Temperature	-55°C to + 150°C
Operating Temperature	-55°C to + 100°C
Lead Soldering Temperature (1/16 inch (1.6mm) from case for 10 secs)	260°C

INPUT DIODE

Forward Current	80mA
Reverse Voltage	5V
Power Dissipation	105mW

OUTPUT TRANSISTOR

Collector-emitter Voltage BV _{CEO}	30V
Collector-base Voltage BV _{CBO}	50V
Emitter-collector Voltage BV _{ECO}	5V
Power Dissipation	150mW

POWER DISSIPATION

Total Power Dissipation	250mW
(derate linearly 3.3mW/°C above 25°C)	

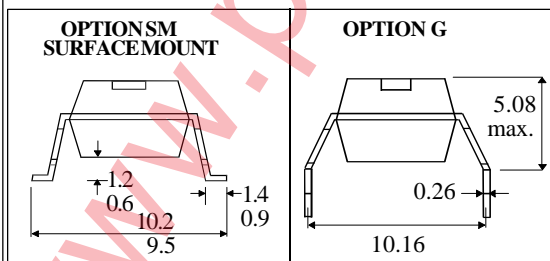

ISOCOM COMPONENTS LTD
 Unit 25B, Park View Road West,
 Park View Industrial Estate, Brenda Road
 Hartlepool, Cleveland, TS25 1YD
 Tel: (01429) 863609 Fax :(01429) 863581

ELECTRICAL CHARACTERISTICS ($T_A = 25^\circ\text{C}$ Unless otherwise noted)

PARAMETER		MIN	TYP	MAX	UNITS	TEST CONDITION
Input	Forward Voltage (V_F)		1.2	1.5	V	$I_F = 10\text{mA}$
	Reverse Voltage (V_R)	3			V	$I_R = 10\mu\text{A}$
	Reverse Current (I_R)			10	μA	$V_R = 3\text{V}$
Output	Collector-emitter Breakdown (BV_{CEO})	30			V	$I_C = 1\text{mA}$ (note 2)
	Collector-base Breakdown (BV_{CBO})	30			V	$I_C = 100\mu\text{A}$
	Emitter-collector Breakdown (BV_{ECO})	5			V	$I_E = 100\mu\text{A}$
	H_{FE}		16K			$V_{CE} = 5\text{V}, I_C = 5\text{mA}$
	Collector-emitter Dark Current (I_{CEO})			100	nA	$V_{CE} = 10\text{V}$
Coupled	Current Transfer Ratio (CTR)(Note 2)					
	H11B1	500			%	$1\text{mA } I_F, 5\text{V } V_{CE}$
	H11B2	200			%	$1\text{mA } I_F, 5\text{V } V_{CE}$
	H11B3	100			%	$1\text{mA } I_F, 5\text{V } V_{CE}$
	Collector-emitter Saturation Voltage $V_{CE(SAT)}$			1.0	V	$1\text{mA } I_F, 1\text{mA } I_C$
	Input to Output Isolation Voltage V_{ISO}	5300			V_{RMS}	(note 1)
	Input-output Isolation Resistance R_{ISO}	7500 5×10^{10}			V_{PK} Ω	(note 1) $V_{IO} = 500\text{V}$ (note 1)
Output Turn on Time t_{on}		125		μs	$V_{CC} = 10\text{V}, I_C = 10\text{mA},$ $R_L = 100\Omega, \text{fig.1}$	
Output Turn off Time t_{off}		100		μs		

- Note 1 Measured with input leads shorted together and output leads shorted together.
 Note 2 Special Selections are available on request. Please consult the factory.

FIGURE 1

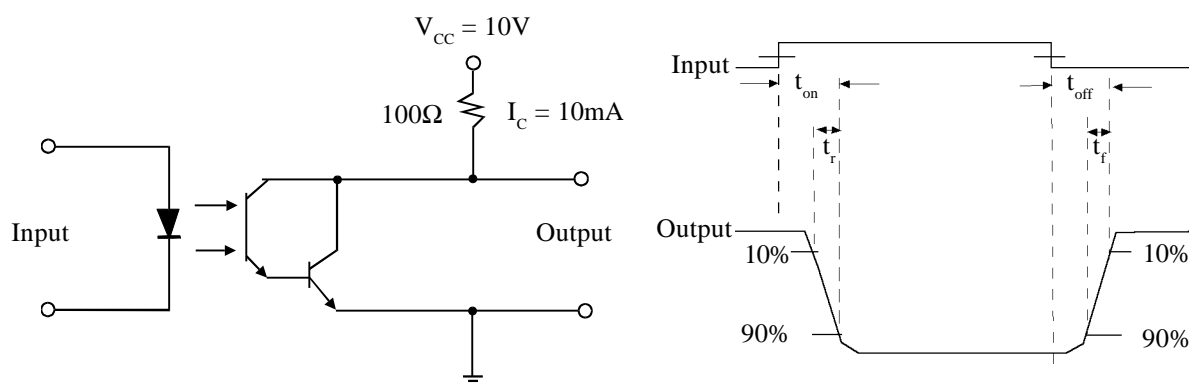

Collector Power Dissipation vs. Ambient Temperature



Current Transfer Ratio vs. Forward Current

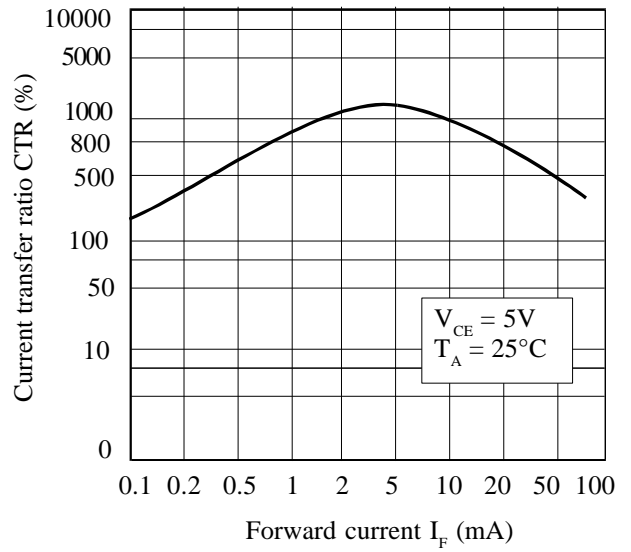

Forward Current vs. Ambient Temperature

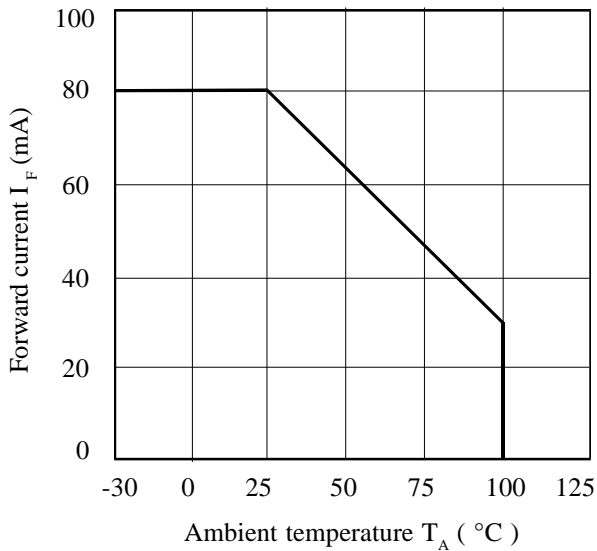

Collector Current vs. Collector-emitter Voltage

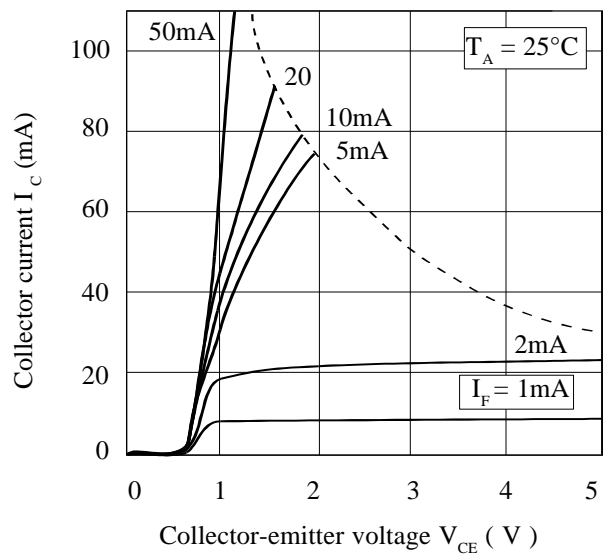

Collector-emitter Saturation Voltage vs. Ambient Temperature

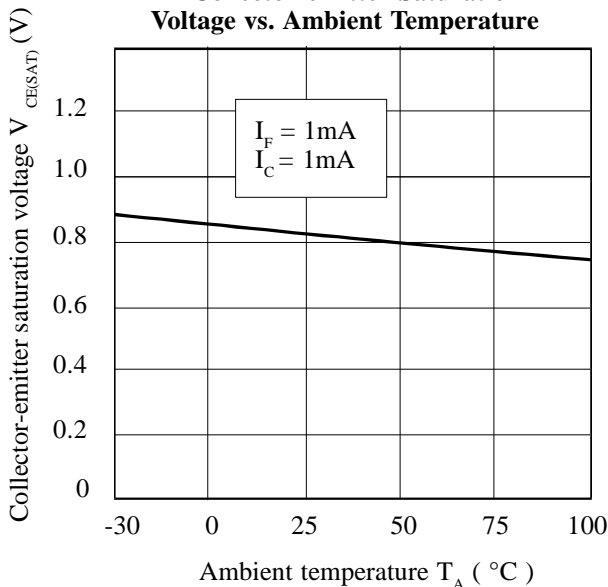

Normalised Current Transfer Ratio vs. Ambient Temperature

