



GAMMA series

7 functions

10 time ranges

Connection of remote potentiometer possible

Zoom voltage 24 to 240V AC/DC

2 change-over contacts

Width 22.5mm

Industrial design



Technical data

1. Functions

Ip	Asymmetric flasher pause first
li	Asymmetric flasher pulse first
ER	ON delay and OFF delay with control input
EWu	ON delay and single shot leading edge with control input
EWs	ON delay single shot leading edge voltage controlled
WsWa	Single shot leading and single shot trailing edge with control contact

2. Time ranges

Time range	Adjustment range	
1s	50ms	1s
3s	150ms	3s
10s	500ms	10s
30s	1500ms	30s
1min	3s	1min
3min	9s	3min
10min	30s	10min
30min	90s	30min
1h	3min	1h
10h	30min	10h

3. Indicators

Green LED U/t1 ON:	indication of supply voltage
Green LED U/t1 flashes:	indication of time period t1
Green LED t2 flashes:	indication of time period t2
Yellow LED ON/OFF:	indication of relay output

4. Mechanical design

Self-extinguishing plastic housing, IP rating IP40
 Mounted on DIN-Rail TS 35 according to EN 60715
 Mounting position: any
 Shockproof terminal connection according to VBG 4 (PZ1 required), IP rating IP20
 Tightening torque: max. 1Nm
 Terminal capacity:
 1 x 0.5 to 2.5mm² with/without multicore cable end
 1 x 4mm² without multicore cable end
 2 x 0.5 to 1.5mm² with/without multicore cable end
 2 x 2.5mm² flexible without multicore cable end

5. Input circuit

Supply voltage:
 24 to 240V AC/DC terminals A1-A2 (galvanically separated)
 Tolerance:
 24 to 240V DC -20% to +25%
 24 to 240V AC -15% to +10%
 Rated frequency:
 24 to 240V AC 48 to 400Hz
 48 to 240V AC 16 to 48Hz
 Rated consumption: 4.5VA (1W)
 Duration of operation: 100%
 Reset time: 500ms
 Wave form for AC: Sinus
 Residual ripple for DC: 10%
 Drop-out voltage: >15% of the supply voltage
 Overvoltage category: III (in accordance with IEC 60661-1)

Rated surge voltage: 4kV

6. Output circuit

2 potential free change over contacts
 Rated voltage: 250V AC
 Switching capacity: 750VA (3A / 250V AC)
 If the distance between the devices is less than 5mm!

Switching capacity: 1250VA (5A / 250V AC)
 If the distance between the devices is greater than 5mm!

Fusing: 5A fast acting
 Mechanical life: 20 x 10⁶ operations
 Electrical Life: 2 x 10⁵ operations at 1000VA resistive load
 Switching frequency: max. 60/min at 100VA resistive load
 max. 6/min at 1000VA resistive load (in accordance with IEC 60947-5-1)
 Overvoltage category: III (in accordance with IEC 60664-1)
 Rated surge voltage: 4kV

7. Control contact

Activation: bridge Y1-Y2
 Potential free: yes, basic isolation against input and output circuit
 Loadable: no
 Control voltage: max. 5V
 Short circuit current: max. 1mA
 Line length: max. 10m
 Control pulse length: min. 50ms (except Wt function)
 min. 7ms (Wt function only)

8. Remote potentiometer (not included)

The internal potentiometer is de-activated when a remote potentiometer is connected !!!
 Connections: 1MΩ potentiometer (type RONDO R2), terminals Y2-Z1 resp. Y2-Z2
 Line type: twisted pair
 Control voltage: max. 5V
 Short circuit current: max. 5μA
 Line length: max. 5m

9. Accuracy

Base accuracy: ±1% (of maximum scale value) using 1MΩ remote potentiometer
 Frequency response: -
 Adjustment accuracy: ≤5% (of maximum scale value) using 1MΩ remote potentiometer
 Repetition accuracy: <0.5% or ±5ms

Technical data

10. Ambient conditions

- Ambient temperature: -25 to +55°C
(in accordance with IEC 60068-1)
- 25 to +40°C
(in accordance with UL 508)
- Storage temperature: -25 to +70°C
- Transport temperature: -25 to +70°C
- Relative humidity: 15% to 85%
(in accordance with IEC 60721-3-3class 3K3)
- Pollution degree: 3 (in accordance with IEC 60664-1)
- Vibration resistance: 10 to 55Hz 0.35mm
(in accordance with IEC 60068-2-6)
- Shock resistance: 15g 11ms (in accordance with IEC 60068-2-27)

Functions

The internal potentiometer is de-activated when a remote-potential-meter is connected ! The function has to be set before connecting the relay to the supply voltage.

Asymmetric flasher pause first (Ip)

When the supply voltage U is applied, the set interval t1 begins (green LED U/t1 flashes). After the interval t1 has expired (green LED U/t1 illuminated), the output relay R switches into on-position (yellow LED illuminated) and the set interval t2 begins (green LED t2 flashes). After the interval t2 has expired (green LED t2 not illuminated), the output relay switches into off-position (yellow LED not illuminated). The output relay is triggered at the ratio of t1:t2 until the supply voltage is interrupted.

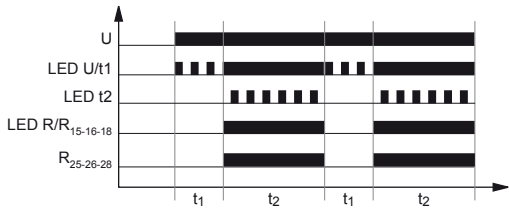

Asymmetric flasher pulse first (Ii)

When the supply voltage U is applied, the output relay R switches into on-position (yellow LED illuminated) and the set interval t1 begins (green LED U/t1 flashes). After the interval t1 has expired (green LED U/t1 illuminated), the output relay switches into off-position (yellow LED not illuminated) and the set interval t2 begins (green LED t2 flashes). After the interval t2 has expired (green LED t2 not illuminated), the output relay switches into on-position (yellow LED illuminated). The output relay is triggered at the ratio of t1:t2 until the supply voltage is interrupted.

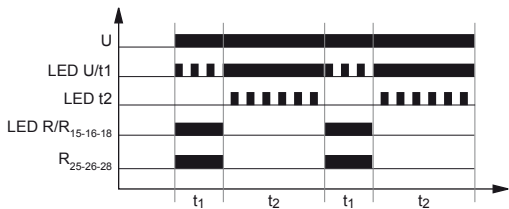

ON delay and OFF delay with control contact (ER)

The supply voltage U must be constantly applied to the device (green LED U/t1 illuminated). When the control contact S is closed, the set interval t1 begins (green LED U/t1 flashes). After the interval t1 has expired (green LED U/t1 illuminated), the output relay R switches into on-position (yellow LED illuminated). If the control contact is opened, the set interval t2 begins (green LED t2 flashes). After the interval t2 has expired (green LED t2 not illuminated) the output relay switches into off-position (yellow LED not illuminated). If the control contact is opened before the interval t1 has expired, the interval already expired is erased and is restarted with the next cycle.

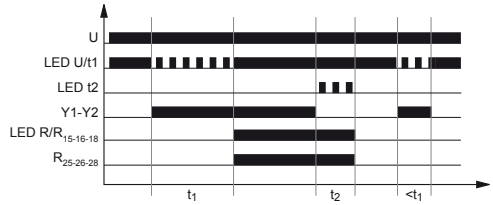

ON delay and single shot leading edge voltage controlled (EWu)

When the supply voltage U is applied, the set interval t1 begins (green LED U/t1 flashes). After the interval t1 has expired (green LED U/t1 illuminated), the output relay R switches into on-position (yellow LED illuminated) and the set interval t2 begins (green LED t2 flashes). After the interval t2 has expired (green LED t2 not illuminated), the output relay switches into off-position (yellow LED not illuminated). If the supply voltage is interrupted before the interval t1+t2 has expired, the interval already expired is erased and is restarted when the supply voltage is next applied.

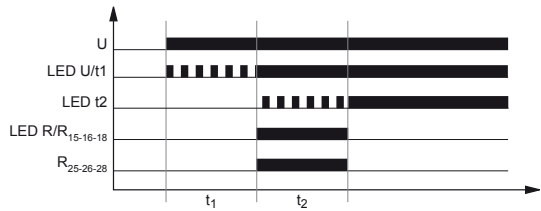

ON delay and single shot leading edge with control contact (EWs)

The supply voltage U must be constantly applied to the device (green LED U/t1 illuminated). When the control contact S is closed, the set interval t1 begins (green LED U/t1 flashes). After the interval t1 has expired (green LED U/t1 illuminated), the output relay R switches into on-position (yellow LED illuminated) and the set interval t2 begins (green LED t2 flashes). After the interval t2 has expired (green LED t2 not illuminated) the output relay switches into off-position (yellow LED not illuminated). During the interval, the control contact can be operated any number of times. A further cycle can only be started when the cycle run has been completed.

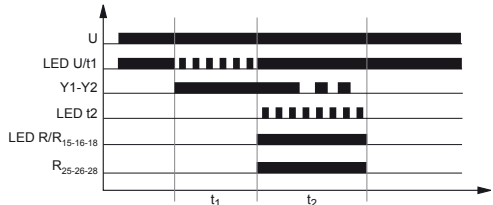

Functions

Single shot leading and single shot trailing edge with control contact (WsWa)

The supply voltage U must be constantly applied to the device (green LED U/t1 illuminated). When the control contact S is closed, the output relay R switches into on-position (yellow LED illuminated) and the set interval t1 begins (green LED U/t1 flashes). After the interval t1 has expired (green LED U/t1 illuminated), the output relay R switches into off-position (yellow LED not illuminated). If the control contact is opened, the output relay again switches into on-position (yellow LED illuminated) and the set interval t2 begins (green LED t2 flashes). After the interval t2 has expired (green LED t2 not illuminated) the output relay switches into off-position (yellow LED not illuminated). During the interval, the control contact can be operated any number of times.

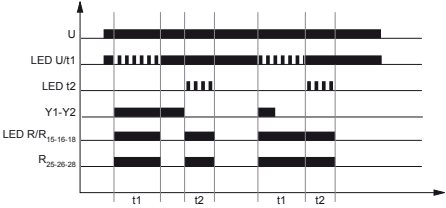

Connections

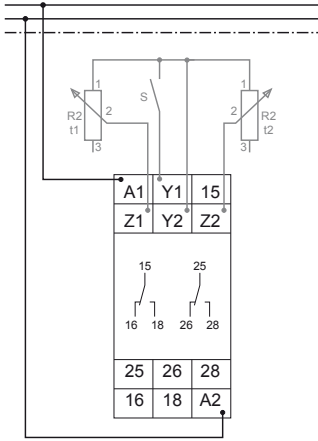

Pulse sequence monitoring (Wt)

When the supply voltage U is applied, the set interval t1 begins (green LED U/t1 flashes) and the output relay R1 (15-16-18) switches into on-position (yellow LED illuminated). After the interval t1 has expired (green LED U/t1 illuminated), the set interval t2 begins (green LED t2 flashes). So that the output relay R1 remains in on-position, the control contact must be closed and opened again within the set interval t2. If this does not happen, the output relay R1 switches into off-position (yellow LED not illuminated) and the output relay R2 (25-26-28) switches into on-position. All further pulses at the control contact are ignored. To restart the function the supply voltage must be interrupted and re-applied.

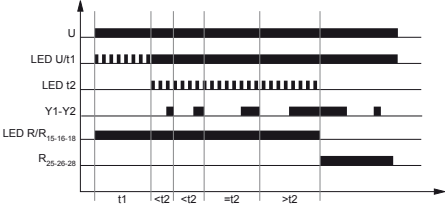

Dimensions

