

1N5345B ... 1N5388B (5 W)

Silicon-Power-Zener Diodes (non-planar technology) Silizium-Leistungs-Zener-Dioden (flächendiffundierte Dioden)

Version 2010-03-30

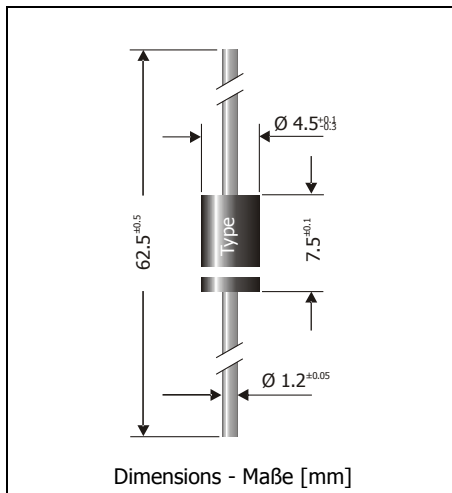

Maximum power dissipation Maximale Verlustleistung	5 W
Nominal Z-voltage Nominale Z-Spannung	8.7...200 V
Plastic case Kunststoffgehäuse	~ DO-201
Weight approx. Gewicht ca.	0.8 g
Plastic material has UL classification 94V-0 Gehäusematerial UL94V-0 klassifiziert	
Standard packaging taped and reeled Standard Lieferform gegurtet auf Rolle	



Standard Zener voltage tolerance is $\pm 5\%$). Other voltage tolerances and higher Zener voltages on request.
Die Toleranz der Zener-Spannung ist in der Standard-Ausführung $\pm 5\%$. Andere Toleranzen oder höhere Arbeitsspannungen auf Anfrage.

Maximum ratings and Characteristics

Grenz- und Kennwerte

Power dissipation Verlustleistung	$T_A = 25^\circ\text{C}$	P_{tot}	5 W ¹⁾
Non repetitive peak power dissipation, $t < 10$ ms Einmalige Impuls-Verlustleistung, $t < 10$ ms	$T_A = 25^\circ\text{C}$	P_{ZSM}	80 W
Operating junction temperature – Sperrschichttemperatur Storage temperature – Lagerungstemperatur		T_j T_S	-50...+150°C -50...+175°C
Thermal resistance junction to ambient air Wärmewiderstand Sperrschicht – umgebende Luft		R_{thA}	< 25 K/W ¹⁾
Thermal resistance junction to terminal Wärmewiderstand Sperrschicht – Anschluss		R_{thL}	< 8 K/W

Zener voltages see table on next page – Zener-Spannungen siehe Tabelle auf der nächsten Seite

- Valid, if leads are kept at ambient temperature at a distance of 10 mm from case
Gültig, wenn die Anschlussdrähte in 10 mm Abstand vom Gehäuse auf Umgebungstemperatur gehalten werden
- Tested with pulses – Gemessen mit Impulsen

Maximum ratings
Grenzwerte

Type Typ	Zener voltage ²⁾ Zener-Spannung ²⁾ $I_z = I_{ztest}$	Test current Mess-Strom	Dynamic resistance Diff. Widerstand $I_z = I_{ztest}$ $I_z = 1 \text{ mA}$		Reverse volt. Sperrspanng. $I_R = 1 \mu\text{A}$	Surge current Stoßstrom $t_p = 8.3 \text{ ms}$	Z-current ¹⁾ Z-Strom ¹⁾ $T_A = 50^\circ\text{C}$
	V_z [V]	I_{ztest} [mA]	r_{zj} [Ω]		V_R [V]	I_{zS} [A]	I_{zmax} [mA]
1N5345B	8.7	150	2	200	> 6.6 (10 μ A)	9.5	546
1N5346B	9.1	150	2	150	> 6.9 (7.5 μ A)	9.2	522
1N5347B	10	125	2	125	> 7.6 (5 μ A)	8.6	475
1N5348B	11	125	2.5	125	> 8.4 (5 μ A)	8.0	432
1N5349B	12	100	2.5	125	> 9.1 (2 μ A)	7.5	396
1N5350B	13	100	2.5	100	> 9.9 (1 μ A)	7.0	365
1N5351B	14	100	2.5	75	> 10.6 (1 μ A)	6.7	339
1N5352B	15	75	2.5	75	> 11.5 (1 μ A)	6.3	317
1N5353B	16	75	2.5	75	> 12.2 (1 μ A)	6.0	297
1N5354B	17	70	2.5	75	> 12.9	5.8	279
1N5355B	18	65	2.5	75	> 13.7	5.5	264
1N5356B	19	65	3	75	> 14.4	5.3	250
1N5357B	20	65	3	75	> 15.2	5.1	238
1N5358B	22	50	3.5	75	> 16.7	4.7	216
1N5359B	24	50	3.5	100	> 18.2	4.4	198
1N5360B	25	50	4	110	> 19.0	4.3	190
1N5361B	27	50	5	120	> 20.6	4.1	176
1N5362B	28	50	6	130	> 21.2	3.9	170
1N5363B	30	40	8	140	> 22.8	3.7	158
1N5364B	33	40	10	150	> 25.1	3.5	144
1N5365B	36	30	11	160	> 27.4	3.3	132
1N5366B	39	30	14	170	> 29.7	3.1	122
1N5367B	43	30	20	190	> 32.7	2.8	110
1N5368B	47	25	25	210	> 35.8	2.7	101
1N5369B	51	25	27	230	> 38.8	2.5	93
1N5370B	56	20	35	280	> 42.6	2.3	85
1N5371B	60	20	40	350	> 45.5	2.2	79
1N5372B	62	20	42	400	> 47.1	2.1	77
1N5373B	68	20	44	500	> 51.7	2.0	70
1N5374B	75	20	45	620	> 56.0	1.9	63
1N5375B	82	15	65	720	> 62.2	1.8	58
1N5376B	87	15	75	760	> 66.0	1.7	55
1N5377B	91	15	75	760	> 69.2	1.6	52
1N5378B	100	12	90	800	> 76.0	1.5	48
1N5379B	110	12	125	1000	> 83.6	1.4	43
1N5380B	120	10	170	1150	> 91.2	1.3	40
1N5381B	130	10	190	1250	> 98.8	1.2	37
1N5382B	140	8	230	1500	> 106	1.2	34
1N5383B	150	8	330	1500	> 114	1.1	32
1N5384B	160	8	350	1650	> 122	1.1	30
1N5385B	170	8	380	1750	> 129	1.0	28
1N5386B	180	5	430	1750	> 137	1.0	26
1N5387B	190	5	450	1850	> 144	0.9	25
1N5388B	200	5	480	1850	> 152	0.9	24

1 Notes see previous page – Fußnoten siehe vorhergehende Seite