

# Three phase full Bridge

with Trench MOSFETs  
in DCB isolated high current package

$V_{DSS} = 40\text{ V}$   
 $I_{D25} = 180\text{ A}$   
 $R_{DSon\ typ.} = 1.9\text{ m}\Omega$

Preliminary data

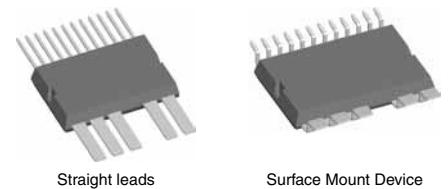
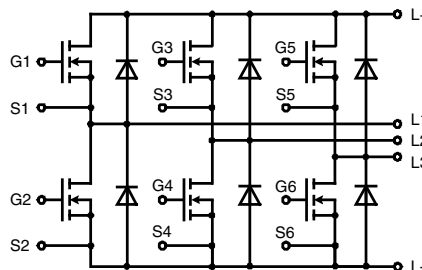

MOSFETs		Maximum Ratings	
Symbol	Conditions		
$V_{DSS}$	$T_J = 25^\circ\text{C to } 150^\circ\text{C}$	40	V
$V_{GS}$		$\pm 20$	V
$I_{D25}$	$T_C = 25^\circ\text{C}$	180	A
$I_{D90}$	$T_C = 90^\circ\text{C}$	136	A
$I_{D110}$	$T_C = 110^\circ\text{C}$	120	A
$I_{F25}$	$T_C = 25^\circ\text{C}$ (diode)	182	A
$I_{F90}$	$T_C = 90^\circ\text{C}$ (diode)	112	A
$I_{F110}$	$T_C = 110^\circ\text{C}$ (diode)	88	A

Symbol	Conditions	Characteristic Values				
		min.	typ.	max.		
$R_{DSon}^{1)}$	on chip level at $V_{GS} = 10\text{ V}; I_D = 100\text{ A}$		1.9 2.8	2.5	$\text{m}\Omega$ $\text{m}\Omega$	
$V_{GS(th)}$	$V_{DS} = 20\text{ V}; I_D = 1\text{ mA}$	2.5		4.5	V	
$I_{DSS}$	$V_{DS} = V_{DSS}; V_{GS} = 0\text{ V}$		50	5	$\mu\text{A}$ $\mu\text{A}$	
$I_{GSS}$	$V_{GS} = \pm 20\text{ V}; V_{DS} = 0\text{ V}$			0.2	$\mu\text{A}$	
$Q_g$ $Q_{gs}$ $Q_{gd}$	$V_{GS} = 10\text{ V}; V_{DS} = 20\text{ V}; I_D = 100\text{ A}$		110 33 30		nC nC nC	
$t_{d(on)}$ $t_r$ $t_{d(off)}$ $t_f$		inductive load $V_{GS} = +10/0\text{ V}; V_{DS} = 24\text{ V}$ $I_D = 135\text{ A}; R_G = 39\ \Omega;$ $T_J = 125^\circ\text{C}$		150 240 350 170		ns ns ns ns
$E_{on}$ $E_{off}$ $E_{recoff}$				0.12 0.51 0.003		mJ mJ mJ
$R_{thJC}$ $R_{thJH}$	with heat transfer paste (IXYS test setup)			1.3	1.0 1.6	K/W K/W

<sup>1)</sup>  $V_{DS} = I_D \cdot (R_{DS(on)} + R_{Pin\ to\ Chip})$

### Applications

- AC drives
- in automobiles
    - electric power steering
    - starter generator
  - in industrial vehicles
    - propulsion drives
    - fork lift drives
  - in battery supplied equipment

### Features

- MOSFETs in trench technology:
  - low  $R_{DSon}$
  - optimized intrinsic reverse diode
- package:
  - high level of integration
  - high current capability 300 A max.
  - aux. terminals for MOSFET control
  - terminals for soldering or welding connections
  - isolated DCB ceramic base plate with optimized heat transfer
- Space and weight savings

### Package options

- 2 lead forms available
  - straight leads (SL)
  - SMD lead version (SMD)

Recommended replacement for the SMD type: MTI150W40GC

**Source-Drain Diode**

Symbol	Conditions	Characteristic Values			
		min.	typ.	max.	
( $T_J = 25^\circ\text{C}$ , unless otherwise specified)					
$V_{SD}$	(diode) $I_F = 100\text{ A}$ ; $V_{GS} = 0\text{ V}$		0.9	1.2	V
$t_{rr}$	} $I_F = 100\text{ A}$ ; $-di_F/dt = 600\text{ A}/\mu\text{s}$ $V_R = 15\text{ V}$ ; $T_{VJ} = 125^\circ\text{C}$		38		ns
$Q_{RM}$			0.31		$\mu\text{C}$
$I_{RM}$			14		A

**Component**

Symbol	Conditions	Maximum Ratings	
$I_{RMS}$	per pin in main current paths (P+, N-, L1, L2, L3) may be additionally limited by external connections	300	A
$T_J$		-55...+175	$^\circ\text{C}$
$T_{stg}$		-55...+125	$^\circ\text{C}$
$V_{ISOL}$	$I_{ISOL} \leq 1\text{ mA}$ , 50/60 Hz, $f = 1\text{ minute}$	1000	V~
$F_C$	mounting force with clip	50 - 250	N

Symbol	Conditions	Characteristic Values		
		min.	typ.	max.
$R_{pin\ to\ chip}^{1)}$	L+ to L1/L2/L3 or L- to L1/L2/L3		1.0	$\text{m}\Omega$
$C_P$	coupling capacity between shorted pins and mounting tab in the case		160	$\text{pF}$
<b>Weight</b>			25	g

<sup>1)</sup>  $V_{DS} = I_D \cdot (R_{DS(on)} + R_{Pin\ to\ Chip})$ 

PHASER

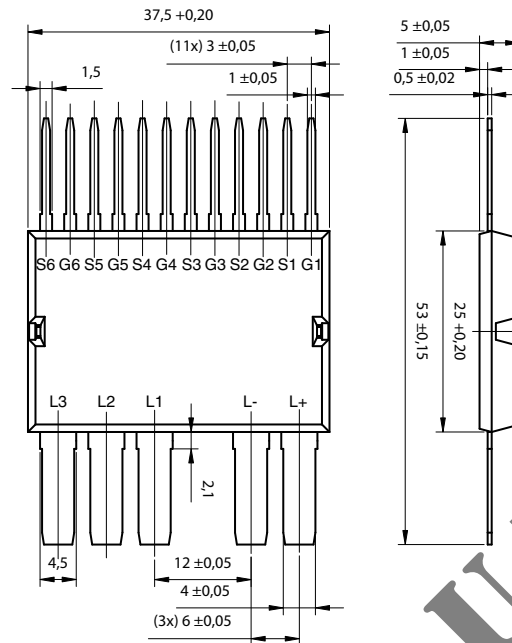
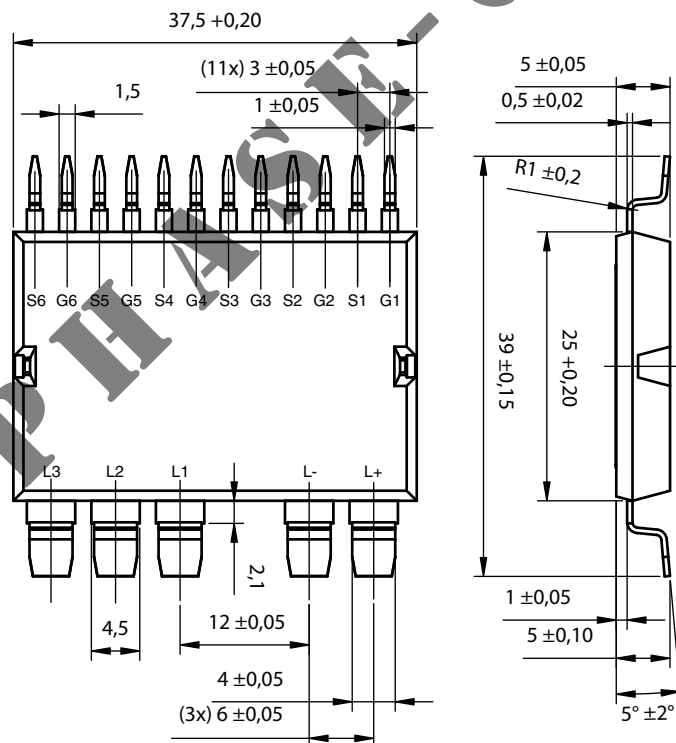
**Straight Leads GWM 180-004X2-SL**

**Surface Mount Device GWM 180-004X2-SMD**

Leads	Ordering	Part Name & Packing Unit Marking	Part Marking	Delivering Mode	Base Qty.	Ordering Code
Straight	Standard	GWM 180-004X2 - SL	GWM 180-004X2	Blister	28	508 772
SMD	Standard	GWM 180-004X2 - SMD	GWM 180-004X2	Blister	28	508 786

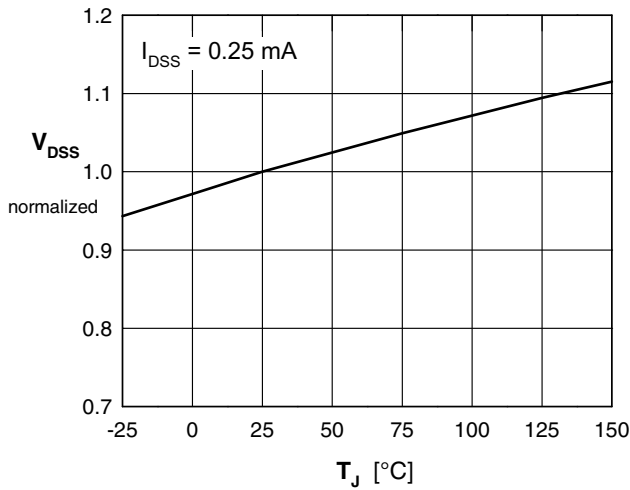

Fig. 1 Drain source breakdown voltage  $V_{DSS}$  versus junction temperature  $T_{VJ}$

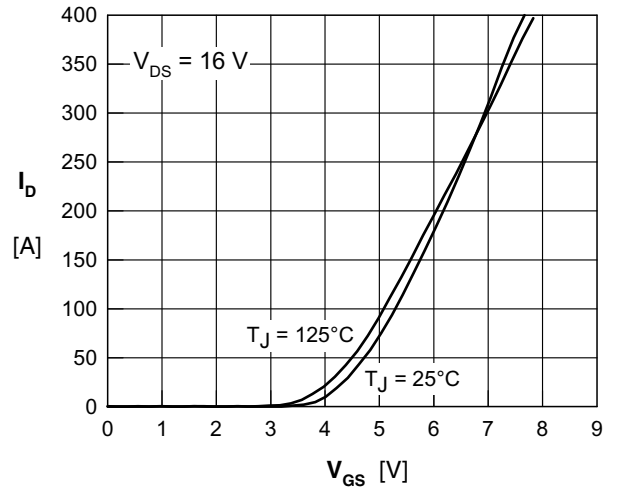

Fig. 2 Typical transfer characteristic

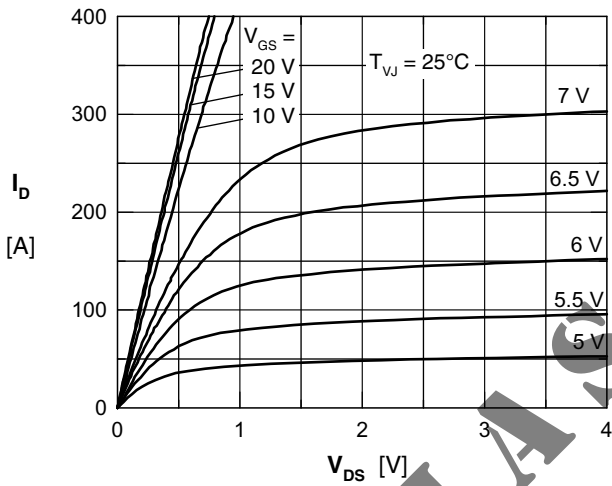

Fig. 3 Typical output characteristic

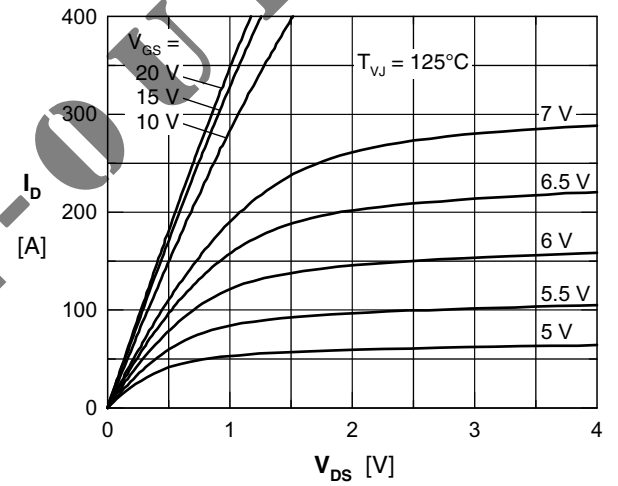

Fig. 4 Typical output characteristic

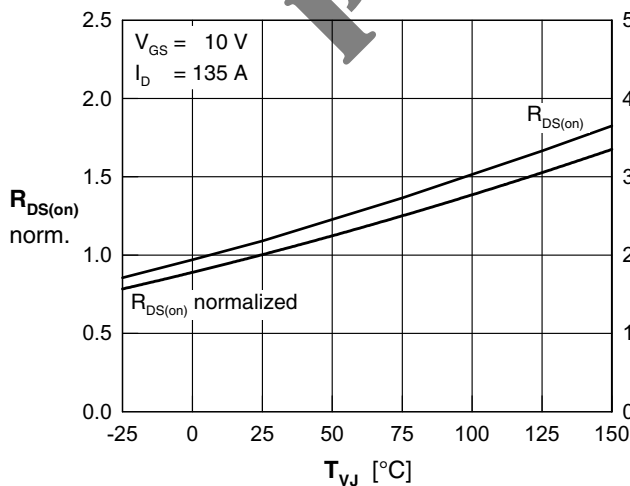

Fig. 5 Typ. drain source on-state resistance  $R_{DS(on)}$  versus junction temperature  $T_J$

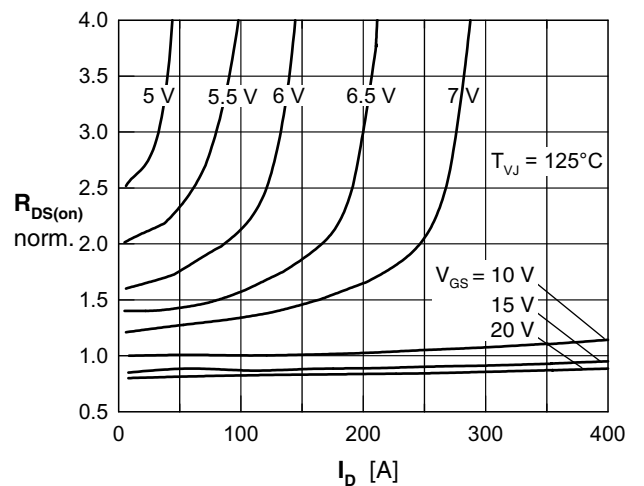

Fig. 6 Typ. drain source on-state resistance  $R_{DS(on)}$  versus  $I_D$

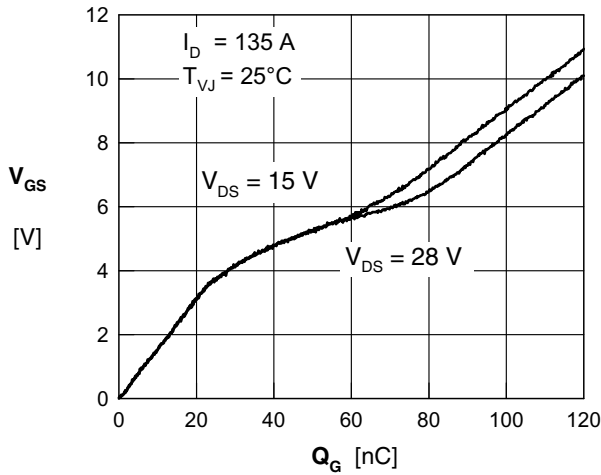

Fig. 7 Gate charge characteristics

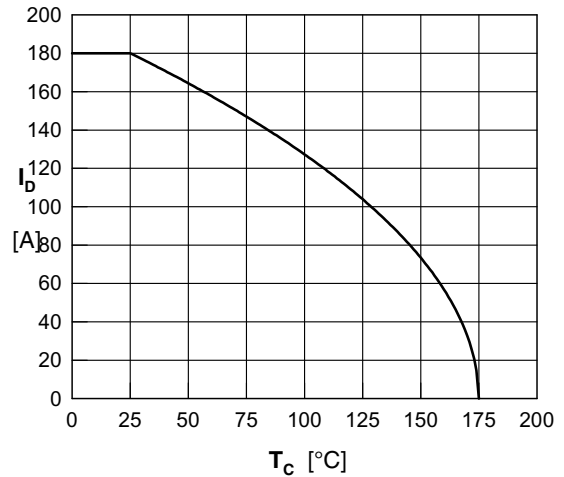

Fig. 8 Drain current  $I_D$  vs. temperature  $T_C$

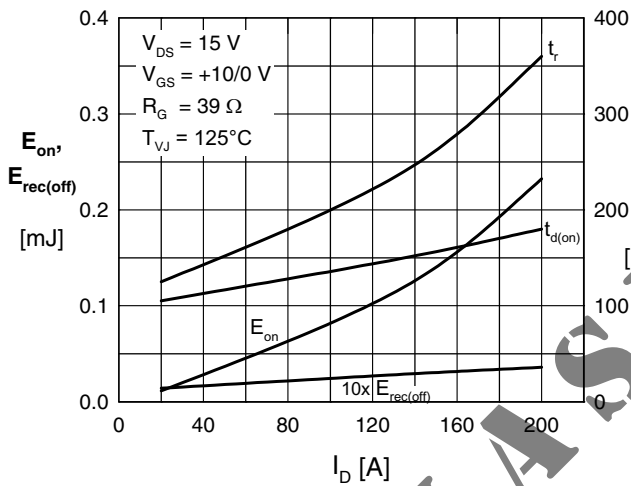

Fig. 9 Typ. turn-on energy & switching times vs. collector current, inductive switching

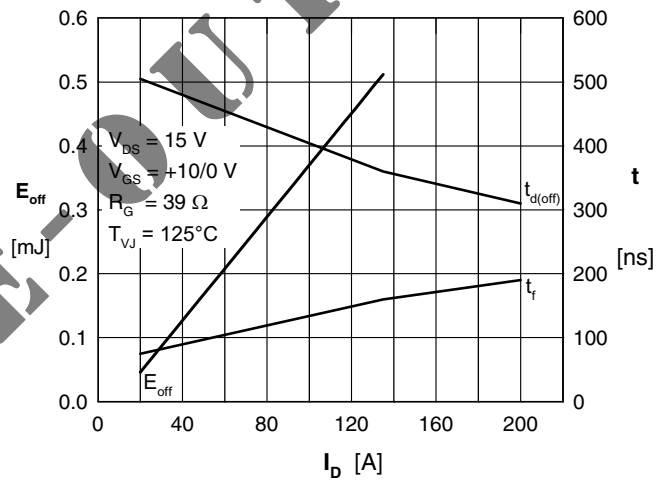

Fig. 10 Typ. turn-off energy & switching times vs. collector current, inductive switching

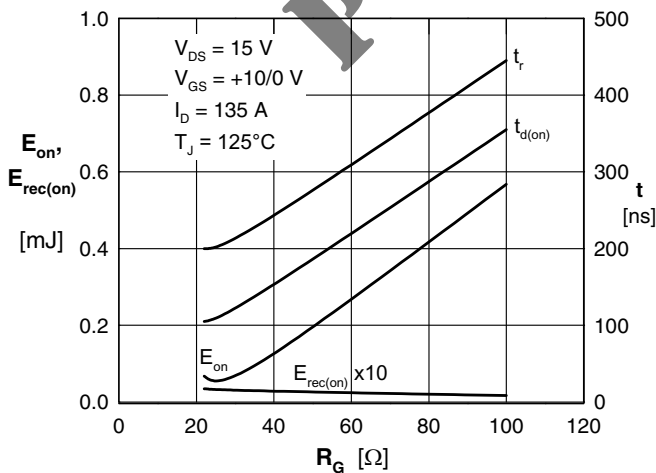

Fig. 11 Typ. turn-on energy & switching times vs. gate resistor, inductive switching

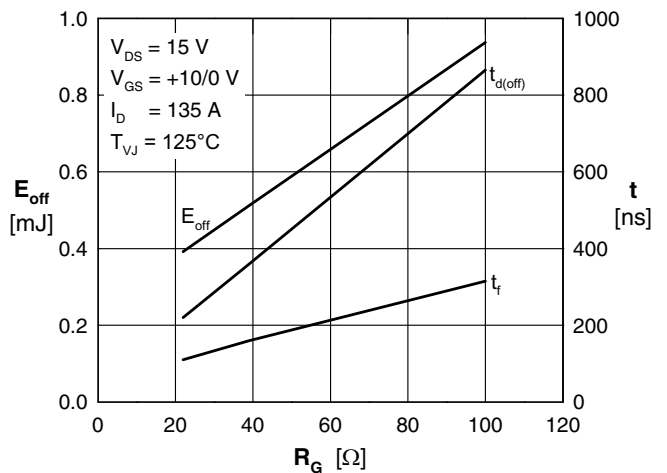

Fig. 12 Typ. turn-off energy & switching times vs. gate resistor, inductive switching

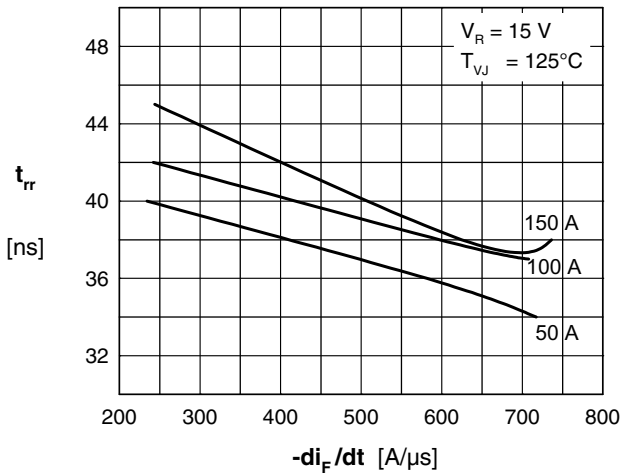

Fig. 13 Reverse recovery time  $t_{rr}$  of the body diodes vs. di/dt

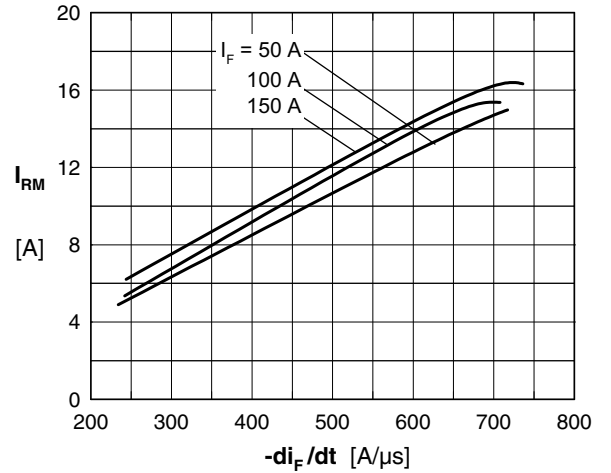

Fig. 14 Reverse recovery current  $I_{RM}$  of the body diodes versus di/dt

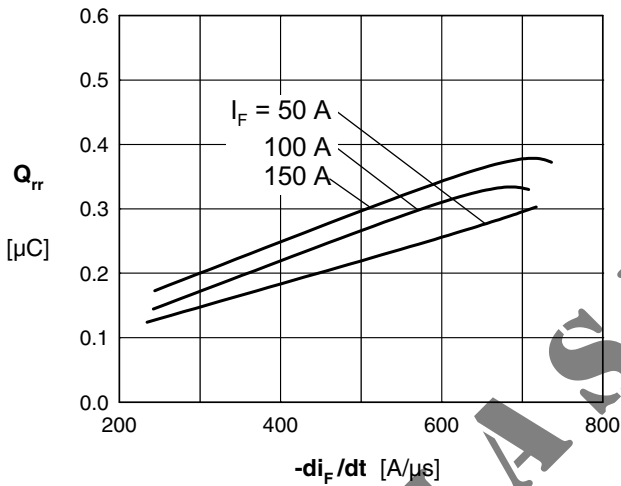

Fig. 15 Reverse recovery charge  $Q_{rr}$  of the body diodes versus di/dt

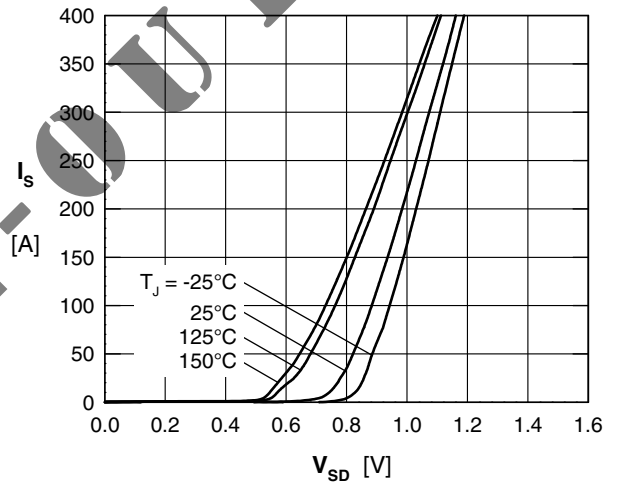

Fig. 16 Source current  $I_s$  versus source drain voltage  $V_{SD}$  (body diode)

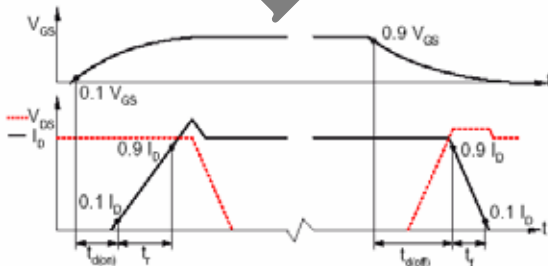

Fig. 17 Definition of switching times