

## LOW-POWER DIFFERENTIAL LINE DRIVER AND RECEIVER PAIRS

Check for Samples: [SN65LBC179A](#), [SN75LBC179A](#)

### FEATURES

- **High-Speed Low-Power LinBiCMOS™ Circuitry Designed for Signaling Rates<sup>(1)</sup> of up to 30 Mbps**
- **Bus-Pin ESD Protection Exceeds 12 kV HBM**
- **Very Low Disabled Supply-Current Requirements . . . 700  $\mu$ A Max**
- **Common-Mode Voltage Range of –7 V to 12 V**
- **Low Supply Current . . .15 mA Max**
- **Compatible With ANSI Standard TIA/EIA-485-A and ISO8482: 1987(E)**
- **Positive and Negative Output Current Limiting**
- **Driver Thermal Shutdown Protection**

<sup>(1)</sup>Signaling rate by TIA/EIA-485-A definition restrict transition times to 30% of the bit length, and much higher signaling rates may be achieved without this requirement as displayed in the *TYPICAL CHARACTERISTICS* of this device.

SN65LBC179AD (Marked as BL179A)  
SN65LBC179AP (Marked as 65LBC179A)  
SN75LBC179AD (Marked as LB179A)  
SN75LBC179AP (Marked as 75LBC179A)

(TOP VIEW)

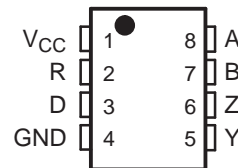

### LOGIC DIAGRAM (POSITIVE LOGIC)

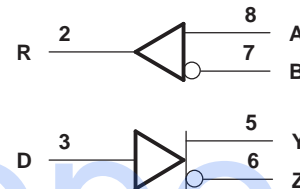

### DESCRIPTION

The SN65LBC179A and SN75LBC179A differential driver and receiver pairs are monolithic integrated circuits designed for bidirectional data communication over long cables that take on the characteristics of transmission lines. They are balanced, or differential, voltage mode devices that are compatible with ANSI standard TIA/EIA-485-A and ISO 8482:1987(E). The A version offers improved switching performance over its predecessors without sacrificing significantly more power.

The SN65LBC179A and SN75LBC179A combine a differential line driver and differential input line receiver and operate from a single 5-V supply. The driver differential outputs and the receiver differential inputs are connected to separate terminals for full-duplex operation and are designed to present minimum loading to the bus when powered off ( $V_{CC} = 0$ ). These parts feature a wide positive and negative common-mode voltage range making them suitable for point-to-point or multipoint data bus applications. The devices also provide positive- and negative-current limiting and thermal shutdown for protection from line fault conditions.

The SN65LBC179A is characterized over the industrial temperature range of –40°C to 85°C. The SN75LBC179A is characterized for operation over the commercial temperature range of 0°C to 70°C.

**FUNCTION TABLE<sup>(1)</sup>**

DRIVER			RECEIVER	
INPUT D	OUTPUTS		DIFFERENTIAL INPUTS A – B	OUTPUT R
	Y	Z		
H	H	L	$V_{ID} \geq 0.2$ V	H
L	L	H	$-0.2$ V < $V_{ID} < 0.2$ V	?
OPEN	H	L	$V_{ID} \leq -0.2$ V	L
	H	L	Open circuit	H

(1) H = high level, L = low level, ? = indeterminate



Please be aware that an important notice concerning availability, standard warranty, and use in critical applications of Texas Instruments semiconductor products and disclaimers thereto appears at the end of this data sheet.

LinBiCMOS is a trademark of Texas Instruments.

PRODUCTION DATA information is current as of publication date. Products conform to specifications per the terms of the Texas Instruments standard warranty. Production processing does not necessarily include testing of all parameters.

Copyright © 2000–2011, Texas Instruments Incorporated



These devices have limited built-in ESD protection. The leads should be shorted together or the device placed in conductive foam during storage or handling to prevent electrostatic damage to the MOS gates.

AVAILABLE OPTIONS

T <sub>A</sub>	PACKAGE	
	SMALL OUTLINE (D)	PLASTIC DUAL-IN-LINE
0°C to 70°C	SN75LBC179AD	SN75LBC179AP
-40°C to 85°C	SN65LBC179AD	SN65LBC179AP

SCHEMATICS OF INPUTS AND OUTPUTS

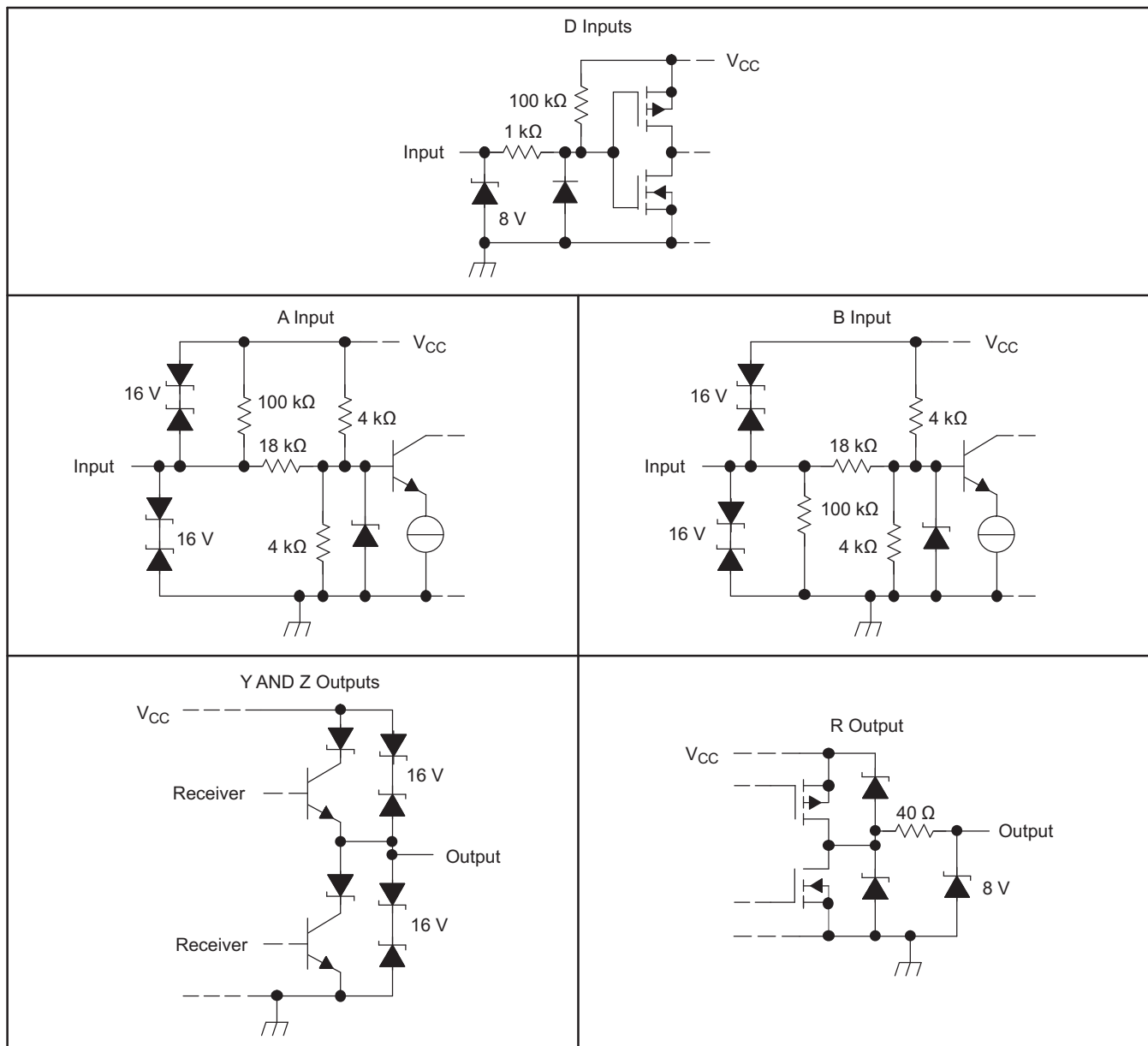

## ABSOLUTE MAXIMUM RATINGS<sup>(1)</sup>

over operating free-air temperature range (unless otherwise noted)

		UNIT
V <sub>CC</sub>	Supply voltage range <sup>(2)</sup>	–0.3 V to 6 V
	Voltage range	A, B, Y, or Z <sup>(2)</sup>
		D or R <sup>(2)</sup>
I <sub>O</sub>	Receiver output current	±20 mA
	Electrostatic discharge	Bus terminals and GND, Class 3, A <sup>(3)</sup>
		Bus terminals and GND, Class 3, B <sup>(3)</sup>
		All terminals, Class 3, A
		All terminals, Class 3, B
Continuous total power dissipation <sup>(4)</sup>		Internally limited
Total power dissipation		See Dissipation Rating Table

- (1) Stresses beyond those listed under *absolute maximum ratings* may cause permanent damage to the device. These are stress ratings only, and functional operation of the device at these or any other conditions beyond those indicated under *recommended operating conditions* is not implied. Exposure to absolute-maximum-rated conditions for extended periods may affect device reliability.
- (2) All voltage values, except differential I/O bus voltages, are with respect to GND.
- (3) Tested in accordance with MIL-STD-883C, Method 3015.7
- (4) The maximum operating junction temperature is internally limited. Uses the dissipation rating table to operate below this temperature.

## DISSIPATION RATINGS

PACKAGE	T <sub>A</sub> ≤ 25°C POWER RATING	DERATING FACTOR <sup>(1)</sup> ABOVE T <sub>A</sub> = 25°C	T <sub>A</sub> = 70°C POWER RATING	T <sub>A</sub> = 85°C POWER RATING
D	725 mW	5.8 mW/°C	464 mW	377 mW
P	1100 mW	8.08 mW/°C	640 mW	520 mW

- (1) This is the inverse of the junction-to-ambient thermal resistance when board-mounted and with no air flow.

## RECOMMENDED OPERATING CONDITIONS

		MIN	NOM	MAX	UNIT
V <sub>CC</sub>	Supply voltage	4.75	5	5.25	V
V <sub>IH</sub>	High-level input voltage	D		V <sub>CC</sub>	V
V <sub>IL</sub>	Low-level input voltage	D		0.8	V
V <sub>ID</sub>	Differential input voltage <sup>(1)</sup>	–12 <sup>(2)</sup>		12	V
V <sub>O</sub>	Voltage at any bus terminal (separately or common-mode)	A, B, Y, or Z	–7	12	V
V <sub>I</sub>					
V <sub>IC</sub>					
I <sub>OH</sub>	High-level output current	Y or Z	–60		mA
		R	–8		
I <sub>OL</sub>	Low-level output current	Y or Z		60	mA
		R		8	
T <sub>A</sub>	Operating free-air temperature	SN65LBC179A	–40	85	°C
		SN75LBC179A	0	70	

- (1) Differential input/output bus voltage is measured at the noninverting terminal with respect to the inverting terminal.
- (2) The algebraic convention, in which the least positive (most negative) limit is designated as minimum, is used in this data sheet.

## DRIVER ELECTRICAL CHARACTERISTICS

over recommended operating conditions (unless otherwise noted)

PARAMETER		TEST CONDITIONS		MIN	TYP <sup>(1)</sup>	MAX	UNIT
$V_{IK}$	Input clamp voltage	$I_I = -18 \text{ mA}$		-1.5	-0.8		V
$ V_{OD} $	Differential output voltage	$R_L = 54 \Omega$ , See <a href="#">Figure 1</a>	SN65LBC179A	1	1.5	3	V
			SN75LBC179A	1.1	1.5	3	V
		$R_L = 60 \Omega$ , $-7 < V_{(tot)} < 12$ , See <a href="#">Figure 2</a>	SN65LBC179A	1	1.5	3	V
			SN75LBC179A	1.1	1.5	3	V
$\Delta  V_{OD} $	Change in magnitude of differential output voltage <sup>(2)</sup>	See <a href="#">Figure 1</a> and <a href="#">Figure 2</a>		-0.2		0.2	V
$V_{OC(SS)}$	Steady-state common-mode output voltage	See <a href="#">Figure 1</a>		1.8	2.4	2.8	V
$\Delta V_{OC(SS)}$	Change in steady-state common-mode output voltage <sup>(2)</sup>			-0.1		0.1	V
$I_O$	Output current with power off	$V_{CC} = 0$ ,	$V_O = -7 \text{ V to } 12 \text{ V}$	-10	$\pm 1$	10	$\mu\text{A}$
$I_{IH}$	High-level input current	$V_I = 2 \text{ V}$		-100			$\mu\text{A}$
$I_{IL}$	Low-level input current	$V_I = 0.8 \text{ V}$		-100			$\mu\text{A}$
$I_{OS}$	Short-circuit output current	$-7 \text{ V} \leq V_O \leq 12 \text{ V}$		-250	$\pm 70$	250	mA
$I_{CC}$	Supply current	No load, $V_I = 0$ or $V_{CC}$			8.5	15	mA

(1) All typical values are at  $V_{CC} = 5 \text{ V}$ ,  $T_A = 25^\circ\text{C}$ .

(2)  $\Delta |V_{OD}|$  and  $\Delta |V_{OC}|$  are the changes in the steady-state magnitude of  $V_{OD}$  and  $V_{OC}$ , respectively, that occur when the input is changed from a high level to a low level.

## DRIVER SWITCHING CHARACTERISTICS

over recommended operating conditions (unless otherwise noted)

PARAMETER		TEST CONDITIONS		MIN	TYP	MAX	UNIT
$t_{PLH}$	Propagation delay time, low-to-high-level output	$R_L = 54 \Omega$ , $C_L = 50 \text{ pF}$ , See <a href="#">Figure 3</a>		2	6	12	ns
$t_{PHL}$	Propagation delay time, high-to-low-level output			2	6	12	ns
$t_{sk(p)}$	Pulse skew ( $ t_{PHL} - t_{PLH} $ )				0.3	1	ns
$t_r$	Differential output signal rise time			4	7.5	11	ns
$t_f$	Differential output signal fall time			4	7.5	11	ns

## RECEIVER SECTION

### RECEIVER ELECTRICAL CHARACTERISTICS

over recommended operating conditions (unless otherwise noted)

PARAMETER		TEST CONDITIONS	MIN	TYP	MAX	UNIT	
$V_{IT+}$	Positive-going input threshold voltage	$I_O = -8\text{ mA}$			0.2	V	
$V_{IT-}$	Negative-going input threshold voltage		-0.2				
$V_{hys}$	Hysteresis voltage ( $V_{IT+} - V_{IT-}$ )	$I_O = 8\text{ mA}$		50		mV	
$V_{OH}$	High-level output voltage	$V_{ID} = 200\text{ mV}$ , $I_{OH} = -8\text{ mA}$ , See Figure 1	4	4.9		V	
$V_{OL}$	Low-level output voltage	$V_{ID} = -200\text{ mV}$ , $I_{OL} = 8\text{ mA}$ , See Figure 1		0.1	0.8	V	
$I_I$	Bus input current	$V_{IH} = 12\text{ V}$ , $V_{CC} = 5\text{ V}$	Other input at 0 V		0.4	1	mA
		$V_{IH} = 12\text{ V}$ , $V_{CC} = 0$			0.5	1	
		$V_{IH} = -7\text{ V}$ , $V_{CC} = 5\text{ V}$		-0.8	-0.4		
		$V_{IH} = -7\text{ V}$ , $V_{CC} = 0$		-0.8	-0.3		

### RECEIVER SWITCHING CHARACTERISTICS

over recommended operating conditions (unless otherwise noted)

PARAMETER		TEST CONDITIONS	MIN	TYP	MAX	UNIT
$t_{PLH}$	Propagation delay time, low-to-high-level output	$V_{ID} = -1.5\text{ V to }1.5\text{ V}$ , See Figure 4	7	13	20	ns
$t_{PHL}$	Propagation delay time, high-to-low-level output		7	13	20	ns
$t_{sk(p)}$	Pulse skew ( $ t_{PLH} - t_{PHL} $ )		0.5	1.5		ns
$t_r$	Rise time, output	See Figure 4	2.1	3.3		ns
$t_f$	Fall time, output		2.1	3.3		ns

### PARAMETER MEASUREMENT INFORMATION

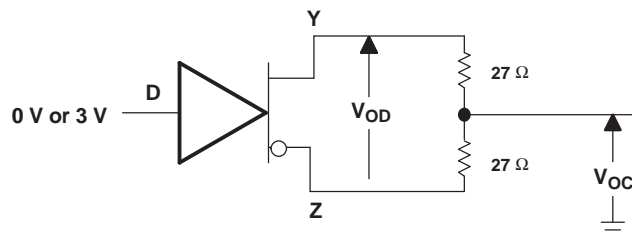

Figure 1. Driver  $V_{OD}$  and  $V_{OC}$

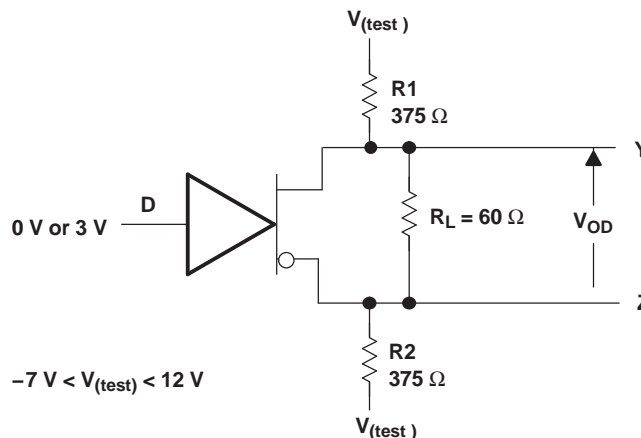
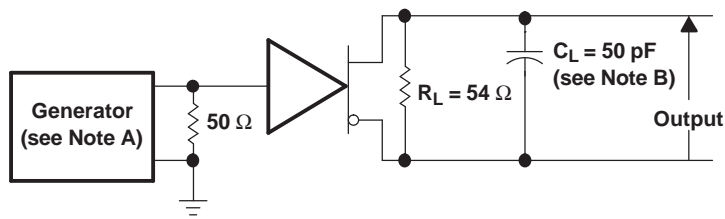
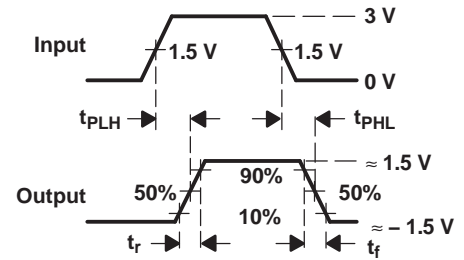

Figure 2. Driver  $V_{OD}$  With Common-Mode Loading

PARAMETER MEASUREMENT INFORMATION (continued)



TEST CIRCUIT



VOLTAGE WAVEFORMS

- A. The input pulse is supplied by a generator having the following characteristics: PRR  $\leq$  1 MHz, 50% duty cycle,  $t_r \leq$  6 ns,  $t_f \leq$  6 ns,  $Z_O = 50 \Omega$ .
- B.  $C_L$  includes probe and jig capacitance.

Figure 3. Driver Test Circuits and Voltage Waveforms

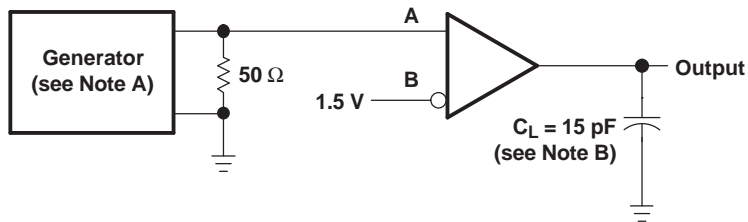

TEST CIRCUIT

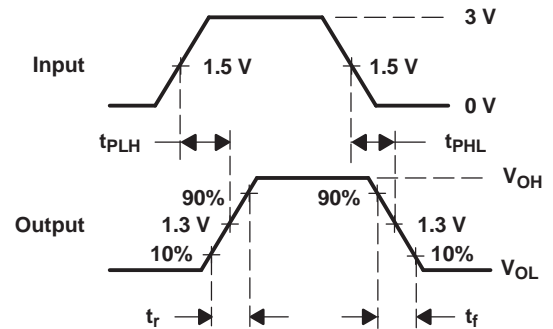

VOLTAGE WAVEFORMS

- A. The input pulse is supplied by a generator having the following characteristics: PRR  $\leq$  1 MHz, 50% duty cycle,  $t_r \leq$  6 ns,  $t_f \leq$  6 ns,  $Z_O = 50 \Omega$ .
- B.  $C_L$  includes probe and jig capacitance.

Figure 4. Receiver Test Circuit and Voltage Waveforms

TYPICAL CHARACTERISTICS

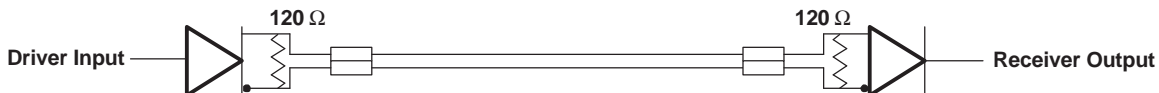
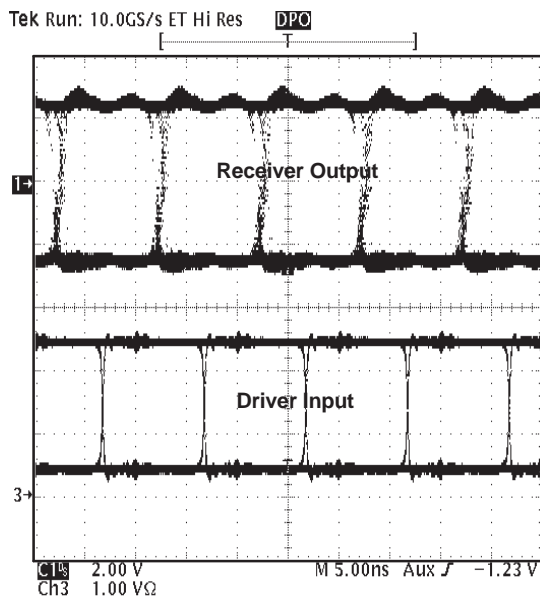

Figure 5. Typical Waveform of Non-Return-To-Zero (NRZ), Pseudorandom Binary Sequence (PRBS) Data at 100 Mbps Through 15m, of CAT 5 Unshielded Twisted Pair (UTP) Cable

TIA/EIA-485-A defines a maximum signaling rate as that in which the transition time of the voltage transition of a logic-state change remains less than or equal to 30% of the bit length. Transition times of greater length perform quite well even though they do not meet the standard by definition.

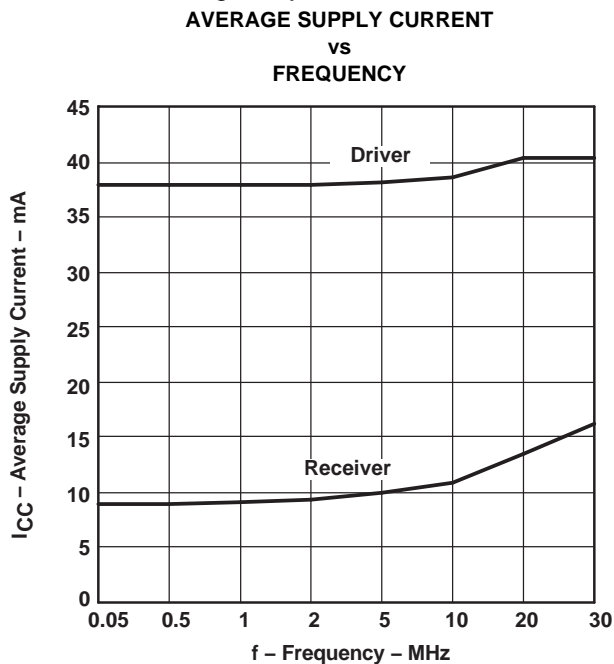

Figure 6.

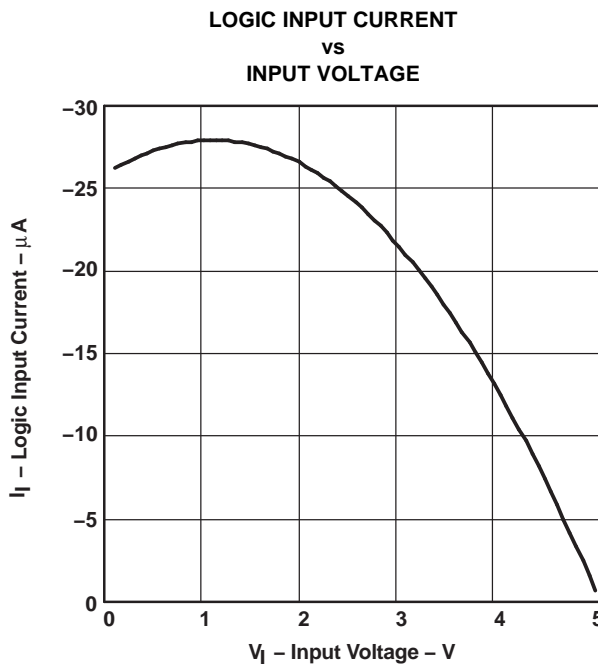

Figure 7.

**TYPICAL CHARACTERISTICS (continued)**

**INPUT CURRENT  
vs  
INPUT VOLTAGE**

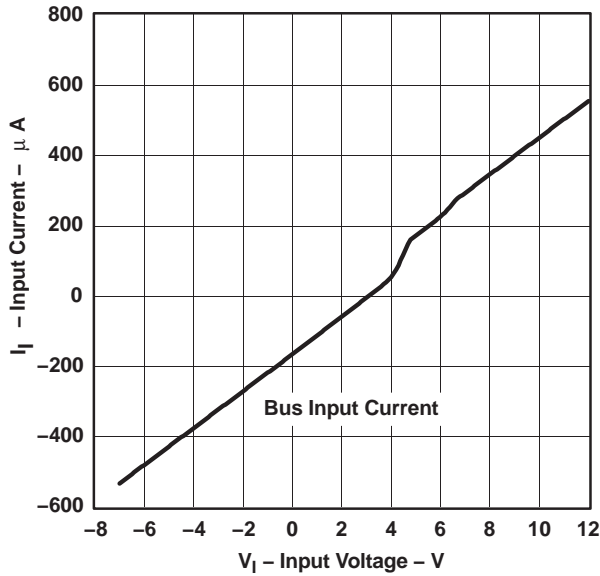

Figure 8.

**LOW-LEVEL OUTPUT VOLTAGE  
vs  
LOW-LEVEL OUTPUT CURRENT**

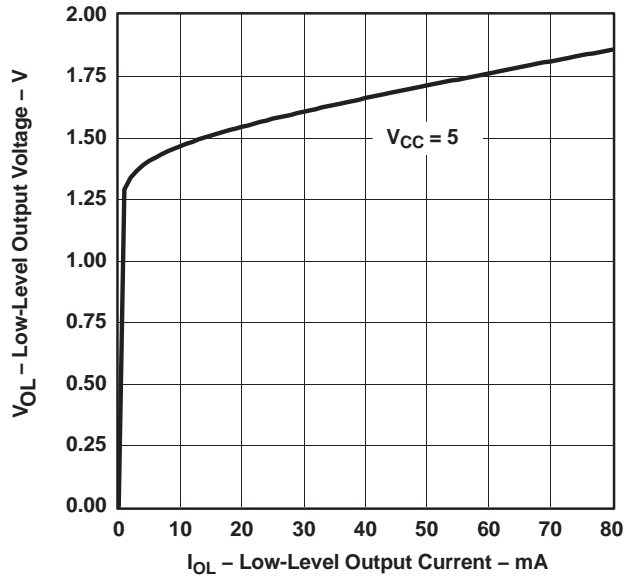

Figure 9.

**DRIVER HIGH-LEVEL OUTPUT VOLTAGE  
vs  
HIGH-LEVEL OUTPUT CURRENT**

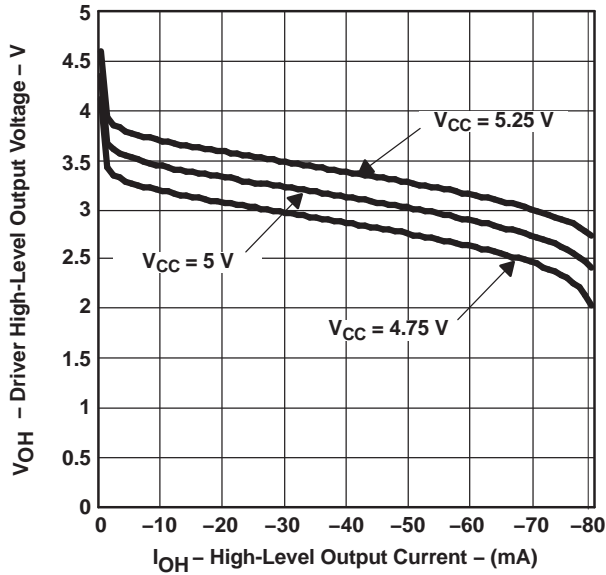

Figure 10.

**DRIVER DIFFERENTIAL OUTPUT VOLTAGE  
vs  
AVERAGE CASE TEMPERATURE**

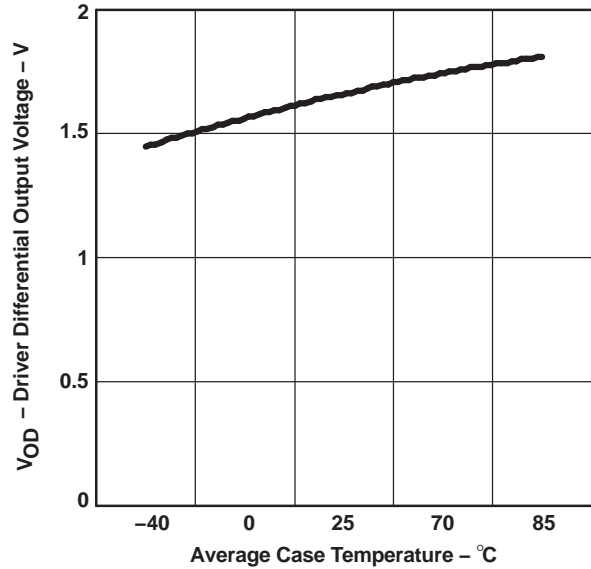

Figure 11.



TYPICAL CHARACTERISTICS (continued)

RECEIVER PROPAGATION TIME  
vs  
CASE TEMPERATURE

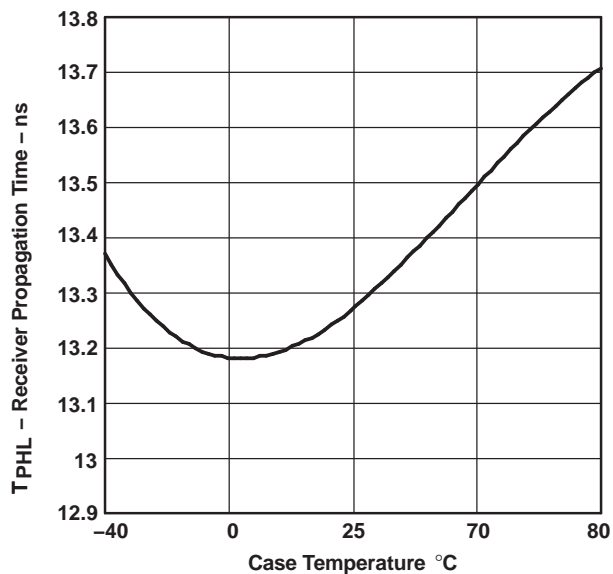

Figure 12.

DRIVER PROPAGATION DELAY TIME  
vs  
CASE TEMPERATURE

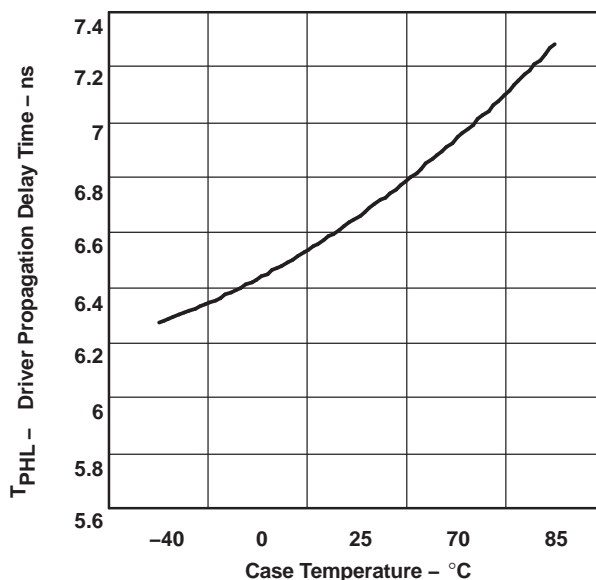

Figure 13.

DRIVER OUTPUT CURRENT  
vs  
SUPPLY VOLTAGE

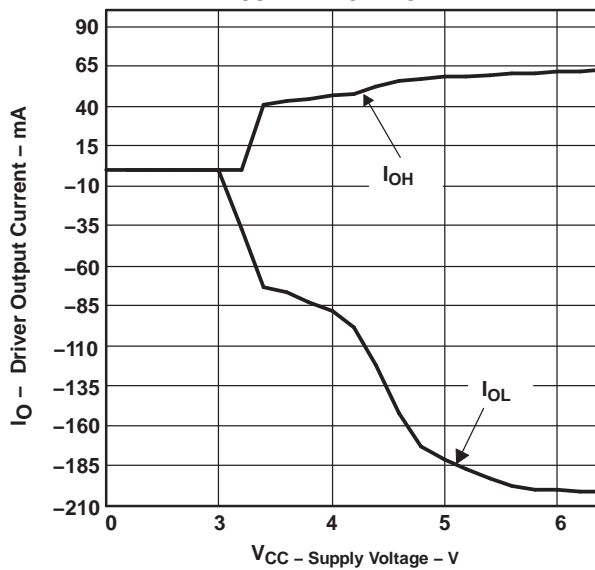

Figure 14.

## REVISION HISTORY

Changes from Revision C (June 2001) to Revision D	Page
• Changed the D Output and R Output schematins .....	2
• Added Receiver output current to the Abs Max Table .....	3
• Changed ESD - All terminals, Class 3, A From: 4 kV To: 3 kV .....	3

**PACKAGING INFORMATION**

Orderable Device	Status <sup>(1)</sup>	Package Type	Package Drawing	Pins	Package Qty	Eco Plan <sup>(2)</sup>	Lead/Ball Finish	MSL Peak Temp <sup>(3)</sup>
SN65LBC179AD	ACTIVE	SOIC	D	8	75	Green (RoHS & no Sb/Br)	CU NIPDAU	Level-1-260C-UNLIM
SN65LBC179ADG4	ACTIVE	SOIC	D	8	75	Green (RoHS & no Sb/Br)	CU NIPDAU	Level-1-260C-UNLIM
SN65LBC179ADR	ACTIVE	SOIC	D	8	2500	Green (RoHS & no Sb/Br)	CU NIPDAU	Level-1-260C-UNLIM
SN65LBC179ADRG4	ACTIVE	SOIC	D	8	2500	Green (RoHS & no Sb/Br)	CU NIPDAU	Level-1-260C-UNLIM
SN65LBC179AP	ACTIVE	PDIP	P	8	50	Pb-Free (RoHS)	CU NIPDAU	N / A for Pkg Type
SN65LBC179APE4	ACTIVE	PDIP	P	8	50	Pb-Free (RoHS)	CU NIPDAU	N / A for Pkg Type
SN75LBC179AD	ACTIVE	SOIC	D	8	75	Green (RoHS & no Sb/Br)	CU NIPDAU	Level-1-260C-UNLIM
SN75LBC179ADG4	ACTIVE	SOIC	D	8	75	Green (RoHS & no Sb/Br)	CU NIPDAU	Level-1-260C-UNLIM
SN75LBC179ADR	ACTIVE	SOIC	D	8	2500	Green (RoHS & no Sb/Br)	CU NIPDAU	Level-1-260C-UNLIM
SN75LBC179ADRG4	ACTIVE	SOIC	D	8	2500	Green (RoHS & no Sb/Br)	CU NIPDAU	Level-1-260C-UNLIM
SN75LBC179AP	ACTIVE	PDIP	P	8	50	Pb-Free (RoHS)	CU NIPDAU	N / A for Pkg Type
SN75LBC179APE4	ACTIVE	PDIP	P	8	50	Pb-Free (RoHS)	CU NIPDAU	N / A for Pkg Type

<sup>(1)</sup> The marketing status values are defined as follows:

**ACTIVE:** Product device recommended for new designs.

**LIFEBUY:** TI has announced that the device will be discontinued, and a lifetime-buy period is in effect.

**NRND:** Not recommended for new designs. Device is in production to support existing customers, but TI does not recommend using this part in a new design.

**PREVIEW:** Device has been announced but is not in production. Samples may or may not be available.

**OBSOLETE:** TI has discontinued the production of the device.

<sup>(2)</sup> Eco Plan - The planned eco-friendly classification: Pb-Free (RoHS), Pb-Free (RoHS Exempt), or Green (RoHS & no Sb/Br) - please check <http://www.ti.com/productcontent> for the latest availability information and additional product content details.

**TBD:** The Pb-Free/Green conversion plan has not been defined.

**Pb-Free (RoHS):** TI's terms "Lead-Free" or "Pb-Free" mean semiconductor products that are compatible with the current RoHS requirements for all 6 substances, including the requirement that lead not exceed 0.1% by weight in homogeneous materials. Where designed to be soldered at high temperatures, TI Pb-Free products are suitable for use in specified lead-free processes.

**Pb-Free (RoHS Exempt):** This component has a RoHS exemption for either 1) lead-based flip-chip solder bumps used between the die and package, or 2) lead-based die adhesive used between the die and leadframe. The component is otherwise considered Pb-Free (RoHS compatible) as defined above.

**Green (RoHS & no Sb/Br):** TI defines "Green" to mean Pb-Free (RoHS compatible), and free of Bromine (Br) and Antimony (Sb) based flame retardants (Br or Sb do not exceed 0.1% by weight in homogeneous material)

<sup>(3)</sup> MSL, Peak Temp. -- The Moisture Sensitivity Level rating according to the JEDEC industry standard classifications, and peak solder temperature.

**Important Information and Disclaimer:**The information provided on this page represents TI's knowledge and belief as of the date that it is provided. TI bases its knowledge and belief on information provided by third parties, and makes no representation or warranty as to the accuracy of such information. Efforts are underway to better integrate information from third parties. TI has taken and continues to take reasonable steps to provide representative and accurate information but may not have conducted destructive testing or chemical analysis on incoming materials and chemicals. TI and TI suppliers consider certain information to be proprietary, and thus CAS numbers and other limited information may not be available for release.

In no event shall TI's liability arising out of such information exceed the total purchase price of the TI part(s) at issue in this document sold by TI to Customer on an annual basis.

## TAPE AND REEL INFORMATION



### QUADRANT ASSIGNMENTS FOR PIN 1 ORIENTATION IN TAPE



\*All dimensions are nominal

Device	Package Type	Package Drawing	Pins	SPQ	Reel Diameter (mm)	Reel Width W1 (mm)	A0 (mm)	B0 (mm)	K0 (mm)	P1 (mm)	W (mm)	Pin1 Quadrant
SN65LBC179ADR	SOIC	D	8	2500	330.0	12.4	6.4	5.2	2.1	8.0	12.0	Q1
SN75LBC179ADR	SOIC	D	8	2500	330.0	12.4	6.4	5.2	2.1	8.0	12.0	Q1

**TAPE AND REEL BOX DIMENSIONS**

\*All dimensions are nominal

Device	Package Type	Package Drawing	Pins	SPQ	Length (mm)	Width (mm)	Height (mm)
SN65LBC179ADR	SOIC	D	8	2500	340.5	338.1	20.6
SN75LBC179ADR	SOIC	D	8	2500	340.5	338.1	20.6

P (R-PDIP-T8)

PLASTIC DUAL-IN-LINE PACKAGE



4040082/E 04/2010

- NOTES:
- A. All linear dimensions are in inches (millimeters).
  - B. This drawing is subject to change without notice.
  - C. Falls within JEDEC MS-001 variation BA.





D (R-PDSO-G8)

PLASTIC SMALL OUTLINE



- NOTES:
- A. All linear dimensions are in millimeters.
  - B. This drawing is subject to change without notice.
  - C. Publication IPC-7351 is recommended for alternate designs.
  - D. Laser cutting apertures with trapezoidal walls and also rounding corners will offer better paste release. Customers should contact their board assembly site for stencil design recommendations. Refer to IPC-7525 for other stencil recommendations.
  - E. Customers should contact their board fabrication site for solder mask tolerances between and around signal pads.

## IMPORTANT NOTICE

Texas Instruments Incorporated and its subsidiaries (TI) reserve the right to make corrections, enhancements, improvements and other changes to its semiconductor products and services per JESD46C and to discontinue any product or service per JESD48B. Buyers should obtain the latest relevant information before placing orders and should verify that such information is current and complete. All semiconductor products (also referred to herein as "components") are sold subject to TI's terms and conditions of sale supplied at the time of order acknowledgment.

TI warrants performance of its components to the specifications applicable at the time of sale, in accordance with the warranty in TI's terms and conditions of sale of semiconductor products. Testing and other quality control techniques are used to the extent TI deems necessary to support this warranty. Except where mandated by applicable law, testing of all parameters of each component is not necessarily performed.

TI assumes no liability for applications assistance or the design of Buyers' products. Buyers are responsible for their products and applications using TI components. To minimize the risks associated with Buyers' products and applications, Buyers should provide adequate design and operating safeguards.

TI does not warrant or represent that any license, either express or implied, is granted under any patent right, copyright, mask work right, or other intellectual property right relating to any combination, machine, or process in which TI components or services are used. Information published by TI regarding third-party products or services does not constitute a license to use such products or services or a warranty or endorsement thereof. Use of such information may require a license from a third party under the patents or other intellectual property of the third party, or a license from TI under the patents or other intellectual property of TI.

Reproduction of significant portions of TI information in TI data books or data sheets is permissible only if reproduction is without alteration and is accompanied by all associated warranties, conditions, limitations, and notices. TI is not responsible or liable for such altered documentation. Information of third parties may be subject to additional restrictions.

Resale of TI components or services with statements different from or beyond the parameters stated by TI for that component or service voids all express and any implied warranties for the associated TI component or service and is an unfair and deceptive business practice. TI is not responsible or liable for any such statements.

Buyer acknowledges and agrees that it is solely responsible for compliance with all legal, regulatory and safety-related requirements concerning its products, and any use of TI components in its applications, notwithstanding any applications-related information or support that may be provided by TI. Buyer represents and agrees that it has all the necessary expertise to create and implement safeguards which anticipate dangerous consequences of failures, monitor failures and their consequences, lessen the likelihood of failures that might cause harm and take appropriate remedial actions. Buyer will fully indemnify TI and its representatives against any damages arising out of the use of any TI components in safety-critical applications.

In some cases, TI components may be promoted specifically to facilitate safety-related applications. With such components, TI's goal is to help enable customers to design and create their own end-product solutions that meet applicable functional safety standards and requirements. Nonetheless, such components are subject to these terms.

No TI components are authorized for use in FDA Class III (or similar life-critical medical equipment) unless authorized officers of the parties have executed a special agreement specifically governing such use.

Only those TI components which TI has specifically designated as military grade or "enhanced plastic" are designed and intended for use in military/aerospace applications or environments. Buyer acknowledges and agrees that any military or aerospace use of TI components which have **not** been so designated is solely at the Buyer's risk, and that Buyer is solely responsible for compliance with all legal and regulatory requirements in connection with such use.

TI has specifically designated certain components which meet ISO/TS16949 requirements, mainly for automotive use. Components which have not been so designated are neither designed nor intended for automotive use; and TI will not be responsible for any failure of such components to meet such requirements.

### Products

Audio	<a href="http://www.ti.com/audio">www.ti.com/audio</a>
Amplifiers	<a href="http://amplifier.ti.com">amplifier.ti.com</a>
Data Converters	<a href="http://dataconverter.ti.com">dataconverter.ti.com</a>
DLP® Products	<a href="http://www.dlp.com">www.dlp.com</a>
DSP	<a href="http://dsp.ti.com">dsp.ti.com</a>
Clocks and Timers	<a href="http://www.ti.com/clocks">www.ti.com/clocks</a>
Interface	<a href="http://interface.ti.com">interface.ti.com</a>
Logic	<a href="http://logic.ti.com">logic.ti.com</a>
Power Mgmt	<a href="http://power.ti.com">power.ti.com</a>
Microcontrollers	<a href="http://microcontroller.ti.com">microcontroller.ti.com</a>
RFID	<a href="http://www.ti-rfid.com">www.ti-rfid.com</a>
OMAP Mobile Processors	<a href="http://www.ti.com/omap">www.ti.com/omap</a>
Wireless Connectivity	<a href="http://www.ti.com/wirelessconnectivity">www.ti.com/wirelessconnectivity</a>

### Applications

Automotive and Transportation	<a href="http://www.ti.com/automotive">www.ti.com/automotive</a>
Communications and Telecom	<a href="http://www.ti.com/communications">www.ti.com/communications</a>
Computers and Peripherals	<a href="http://www.ti.com/computers">www.ti.com/computers</a>
Consumer Electronics	<a href="http://www.ti.com/consumer-apps">www.ti.com/consumer-apps</a>
Energy and Lighting	<a href="http://www.ti.com/energy">www.ti.com/energy</a>
Industrial	<a href="http://www.ti.com/industrial">www.ti.com/industrial</a>
Medical	<a href="http://www.ti.com/medical">www.ti.com/medical</a>
Security	<a href="http://www.ti.com/security">www.ti.com/security</a>
Space, Avionics and Defense	<a href="http://www.ti.com/space-avionics-defense">www.ti.com/space-avionics-defense</a>
Video and Imaging	<a href="http://www.ti.com/video">www.ti.com/video</a>

**TI E2E Community** [e2e.ti.com](http://e2e.ti.com)