

Features

- Glass Passivated Die Construction
- Diffused Junction
- Low Forward Voltage Drop, High Current Capability
- Surge Overload Rating to 50A Peak
- Designed for Printed Circuit Board Applications
- UL Listed Under Recognized Component Index, File Number E94661
- **Lead Free Finish, RoHS Compliant (Note 3)**

Mechanical Data

- Case: DF-M
- Case Material: Molded Plastic. UL Flammability Classification Rating 94V-0
- Moisture Sensitivity: Level 1 per J-STD-020C
- Terminals: Finish - Bright Tin. Solder Plated Leads, Solderable per MIL-STD-202, Method 208
- Also Available in Lead Free Plating (Bright Tin Finish). Please see Ordering Information, Note 5, on Page 3
- Polarity: As Marked on Case
- Marking: Type Number, See Page 3
- Weight: 0.38 grams (approximate)

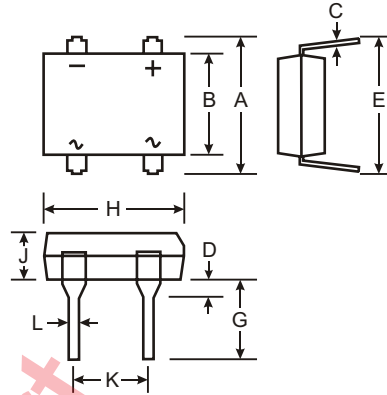

DF-M		
Dim	Min	Max
A	7.40	7.90
B	6.20	6.50
C	0.22	0.30
D	1.27	2.03
E	7.60	8.90
G	3.81	4.69
H	8.13	8.51
J	2.40	2.60
K	5.00	5.20
L	0.46	0.58
M	1.40	1.56
N	2.10	2.34
All Dimensions in mm		

Maximum Ratings and Electrical Characteristics @ T_A = 25°C unless otherwise specified

Single phase, 60Hz, resistive or inductive load.
For capacitive load, derate current by 20%.

Characteristic	Symbol	DF 005M	DF 01M	DF 02M	DF 04M	DF 06M	DF 08M	DF 10M	Unit
Peak Repetitive Reverse Voltage Working Peak Reverse Voltage DC Blocking Voltage	V _{RMM} V _{RWM} V _R	50	100	200	400	600	800	1000	V
RMS Reverse Voltage	V _{RMS}	35	70	140	280	420	580	700	V
Average Rectified Output Current @ T _A = 40°C	I _O	1.0							A
Non-Repetitive Peak Forward Surge Current, 8.3 ms single half-sine-wave superimposed on rated load (JEDEC method)	I _{FSM}	50							A
Forward Voltage (per element) @ I _F = 1.0 A	V _{FM}	1.1							V
Peak Reverse Current @ T _A = 25°C at Rated DC Blocking Voltage (per element) @ T _A = 125°C	I _{RM}	10 500							μA
I ² t Rating for Fusing (t < 8.3ms)	I ² t	10.4							A ² s
Typical Total Capacitance per element (Note 1)	C _T	25							pF
Typical Thermal Resistance, Junction to Ambient (Note 2)	R _{θJA}	40							°C/W
Operating and Storage Temperature Range	T _j , T _{STG}	-65 to +150							°C

- Notes: 1. Measured at 1.0MHz and Applied Reverse Voltage of 4.0V DC.
2. Thermal Resistance, junction to ambient, measured on PC board with 5.0²mm (0.03mm thick) land areas.
3. RoHS revision 13.2.2003. Glass and High Temperature Solder Exemptions Applied, see EU Directive Annex Notes 5 and 7.

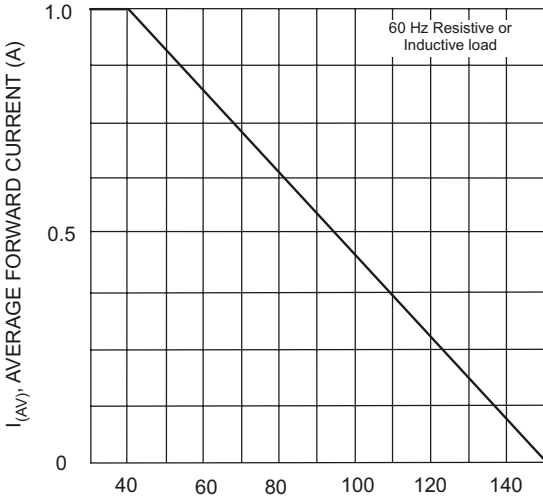

T_A , AMBIENT TEMPERATURE (°C)
Fig. 1 Output Current Derating Curve

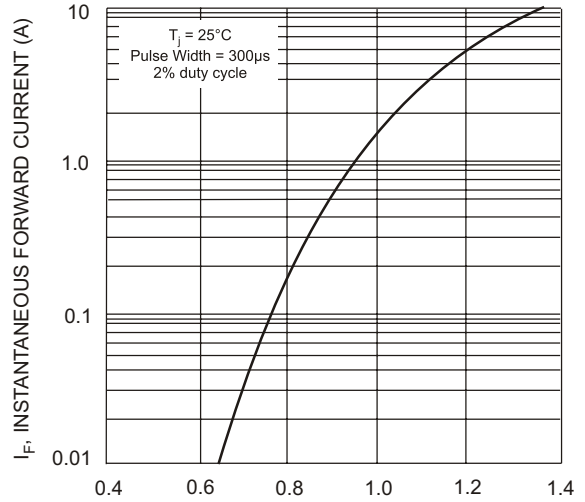

V_F , INSTANTANEOUS FORWARD VOLTAGE (V)
Fig. 2 Typ Forward Characteristics (per element)

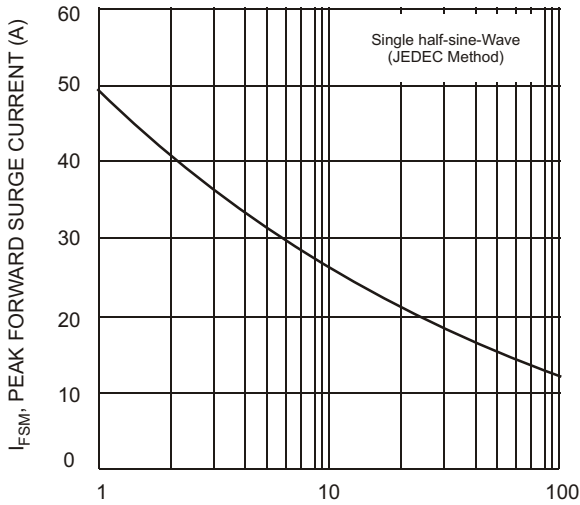

NUMBER OF CYCLES AT 60 Hz
Fig. 3 Max Non-Repetitive Peak Forward Surge Current

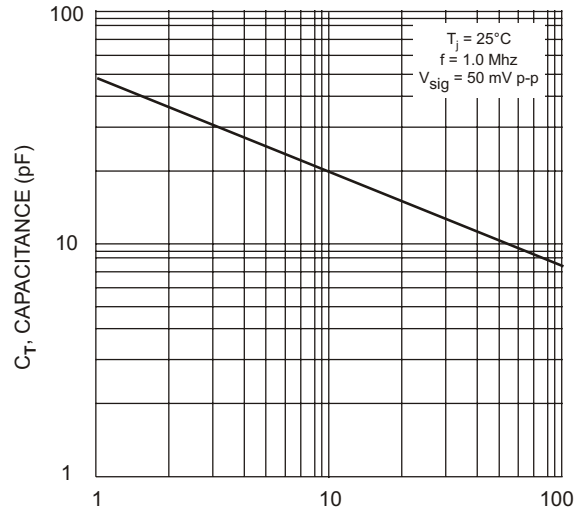

V_R , REVERSE VOLTAGE (V)
Fig. 4 Typ Junction Capacitance (per element)

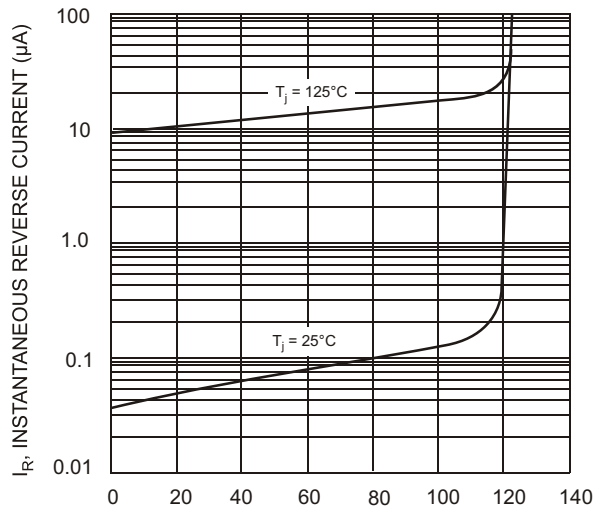

PERCENT OF RATED PEAK REVERSE VOLTAGE (%)
Fig. 5 Typ Reverse Characteristics (per element)

Ordering Information (Notes 4 & 5)

Device*	Packaging	Shipping
DFxM DFxM-T	DF-M DF-M	Tube 1500/Tape & Reel, 13-inch

* x = Device type, e.g. DF005S or DF10S, etc.

- Notes: 4. For Packaging Details, go to our website at <http://www.diodes.com/datasheets/ap02007.pdf>.
5. For Lead Free/RoHS Compliant version part numbers, please add "-F" suffix to the part numbers above. Example: DF10M-T-F.

Marking Information

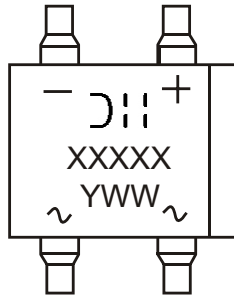

⌋|| = Manufacturers' code marking
 XXXXX = Product type marking code, ex: DF10M
 YWW = Date code marking
 Y = Last digit of year ex: 2 for 2002
 WW = Week code 01 to 52