

### Features

- Glass Passivated Die Construction
- Diffused Junction
- Low Forward Voltage Drop, High Current Capability
- Surge Overload Rating to 50A Peak
- Designed for Printed Circuit Board Applications
- UL Listed Under Recognized Component Index, File Number E94661
- **Lead Free Finish, RoHS Compliant (Note 3)**

### Mechanical Data

- Case: DF-M
- Case Material: Molded Plastic. UL Flammability Classification Rating 94V-0
- Moisture Sensitivity: Level 1 per J-STD-020C
- Terminals: Finish - Bright Tin. Solder Plated Leads, Solderable per MIL-STD-202, Method 208
- Also Available in Lead Free Plating (Bright Tin Finish). Please see Ordering Information, Note 5, on Page 3
- Polarity: As Marked on Case
- Marking: Type Number, See Page 3
- Weight: 0.38 grams (approximate)

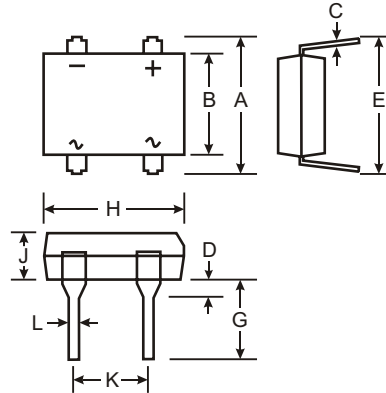

DF-M		
Dim	Min	Max
A	7.40	7.90
B	6.20	6.50
C	0.22	0.30
D	1.27	2.03
E	7.60	8.90
G	3.81	4.69
H	8.13	8.51
J	2.40	2.60
K	5.00	5.20
L	0.46	0.58
M	1.40	1.56
N	2.10	2.34
All Dimensions in mm		

### Maximum Ratings and Electrical Characteristics @ T<sub>A</sub> = 25°C unless otherwise specified

Single phase, 60Hz, resistive or inductive load.  
For capacitive load, derate current by 20%.

Characteristic	Symbol	DF 005M	DF 01M	DF 02M	DF 04M	DF 06M	DF 08M	DF 10M	Unit
Peak Repetitive Reverse Voltage Working Peak Reverse Voltage DC Blocking Voltage	V <sub>RMM</sub> V <sub>RWM</sub> V <sub>R</sub>	50	100	200	400	600	800	1000	V
RMS Reverse Voltage	V <sub>RMS</sub>	35	70	140	280	420	580	700	V
Average Rectified Output Current @ T <sub>A</sub> = 40°C	I <sub>O</sub>	1.0							A
Non-Repetitive Peak Forward Surge Current, 8.3 ms single half-sine-wave superimposed on rated load (JEDEC method)	I <sub>FSM</sub>	50							A
Forward Voltage (per element) @ I <sub>F</sub> = 1.0 A	V <sub>FM</sub>	1.1							V
Peak Reverse Current @ T <sub>A</sub> = 25°C at Rated DC Blocking Voltage (per element) @ T <sub>A</sub> = 125°C	I <sub>RM</sub>	10 500							μA
I <sup>2</sup> t Rating for Fusing (t<8.3ms)	I <sup>2</sup> t	10.4							A <sup>2</sup> s
Typical Total Capacitance per element (Note 1)	C <sub>T</sub>	25							pF
Typical Thermal Resistance, Junction to Ambient (Note 2)	R <sub>θJA</sub>	40							°C/W
Operating and Storage Temperature Range	T <sub>j</sub> , T <sub>STG</sub>	-65 to +150							°C

- Notes: 1. Measured at 1.0MHz and Applied Reverse Voltage of 4.0V DC.  
2. Thermal Resistance, junction to ambient, measured on PC board with 5.0<sup>2</sup>mm (0.03mm thick) land areas.  
3. RoHS revision 13.2.2003. Glass and High Temperature Solder Exemptions Applied, see EU Directive Annex Notes 5 and 7.

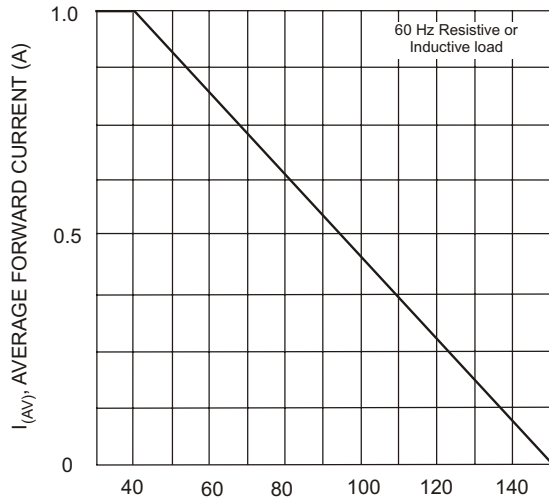

$T_A$ , AMBIENT TEMPERATURE (°C)  
Fig. 1 Output Current Derating Curve

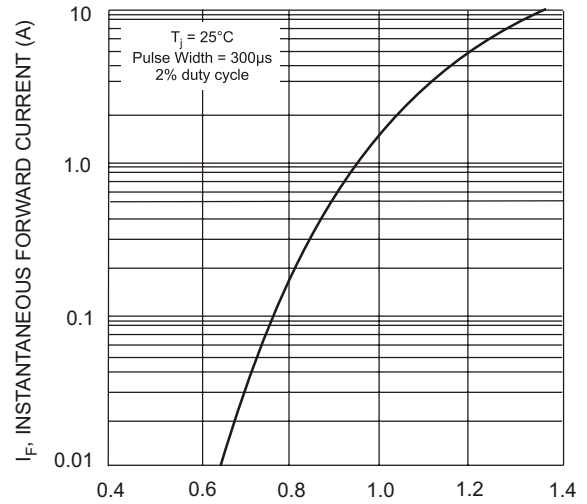

$V_F$ , INSTANTANEOUS FORWARD VOLTAGE (V)  
Fig. 2 Typ Forward Characteristics (per element)

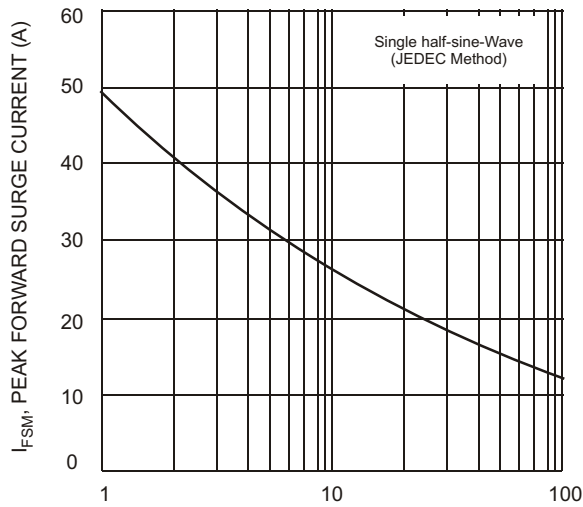

NUMBER OF CYCLES AT 60 Hz  
Fig. 3 Max Non-Repetitive Peak Forward Surge Current

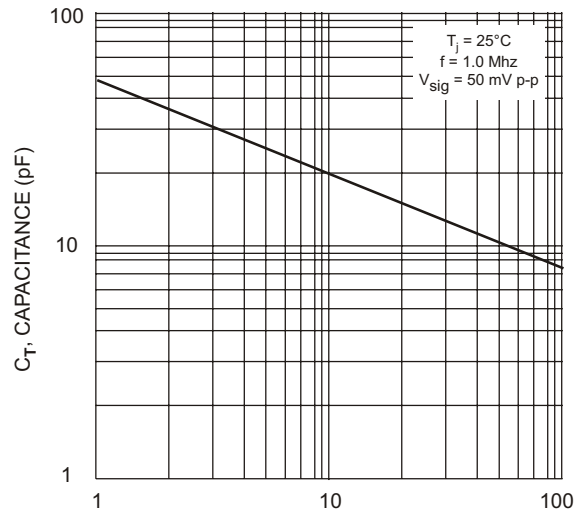

$V_R$ , REVERSE VOLTAGE (V)  
Fig. 4 Typ Junction Capacitance (per element)

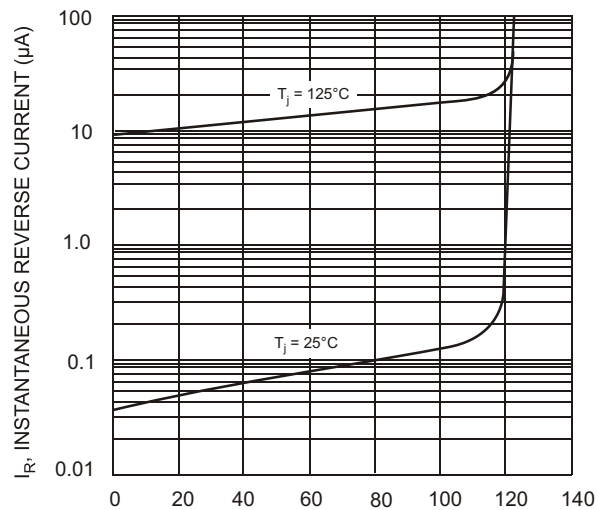

PERCENT OF RATED PEAK REVERSE VOLTAGE (%)  
Fig. 5 Typ Reverse Characteristics (per element)

## Ordering Information (Notes 4 & 5)

Device*	Packaging	Shipping
DFxM DFxM-T	DF-M DF-M	Tube 1500/Tape & Reel, 13-inch

\* x = Device type, e.g. DF005S or DF10S, etc.

- Notes: 4. For Packaging Details, go to our website at <http://www.diodes.com/datasheets/ap02007.pdf>.  
5. For Lead Free/RoHS Compliant version part numbers, please add "-F" suffix to the part numbers above. Example: DF10M-T-F.

## Marking Information

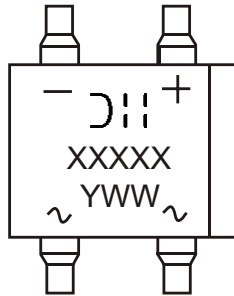

⌋|| = Manufacturers' code marking  
 XXXXX = Product type marking code, ex: DF10M  
 YWW = Date code marking  
 Y = Last digit of year ex: 2 for 2002  
 WW = Week code 01 to 52