

Horizontal Deflection Transistor

... designed for use in televisions.

- Collector–Emitter Voltages V_{CES} 1500 Volts
- Fast Switching — 400 ns Typical Fall Time
- Low Thermal Resistance 1°C/W Increased Reliability
- Glass Passivated (Patented Photoglass). Triple Diffused Mesa Technology for Long Term Stability

BU208A

5.0 AMPERES
NPN SILICON
POWER TRANSISTOR
700 VOLTS

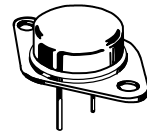

CASE 1-07
TO-204AA
(TO-3)

MAXIMUM RATINGS

Rating	Symbol	BU208A	Unit
Collector–Emitter Voltage	$V_{CEO(sus)}$	700	Vdc
Collector–Emitter Voltage	V_{CES}	1500	Vdc
Emitter–Base Voltage	V_{EB}	5.0	Vdc
Collector Current — Continuous	I_C	5.0	Vdc
— Peak	I_{CM}	7.5	
Base Current — Continuous	I_B	4.0	A dc
— Peak (Negative)	I_{BM}	3.5	
Total Power Dissipation @ $T_C = 95^\circ\text{C}$ Derate above 95°C	P_D	12.5 0.625	Watts W/ $^\circ\text{C}$
Operating and Storage Junction Temperature Range	T_J, T_{stg}	-65 to +115	$^\circ\text{C}$

THERMAL CHARACTERISTICS

Characteristic	Symbol	Max	Unit
Thermal Resistance, Junction to Case	$R_{\theta JC}$	1.6	$^\circ\text{C}/\text{W}$
Maximum Lead Temperature for Soldering Purpose, 1/8" from Case for 5 Seconds	T_L	275	$^\circ\text{C}$

NOTES:

1. Pulsed 5.0 ms, Duty Cycle \leq 10%.
2. See page 3 for Additional Ratings on A Type.
3. Figures in () are Standard Ratings ON Semiconductor Guarantees are Superior.

BU208A

ELECTRICAL CHARACTERISTICS ($T_C = 25^\circ\text{C}$ unless otherwise noted)

Characteristic	Symbol	Min	Typ	Max	Unit
OFF CHARACTERISTICS					
Collector–Emitter Sustaining Voltage ($I_C = 100\text{ mA}$, $L = 25\text{ mH}$)	$V_{CEO(sus)}$	700	—	—	Vdc
Collector Cutoff Current ¹ ($V_{CE} = \text{rated } V_{CES}$, $V_{BE} = 0$)	I_{CES}	—	—	1.0	mAdc
Emitter Base Voltage ¹ ($I_C = 0$, $I_E = 10\text{ mA}$) ($I_C = 0$, $I_E = 100\text{ mA}$)	V_{EBO}	5 —	— 7	— —	Vdc
ON CHARACTERISTICS¹					
DC Current Gain ($I_C = 4.5\text{ Adc}$, $V_{CE} = 5\text{ Vdc}$)	h_{FE}	2.25	—	—	
Collector–Emitter Saturation Voltage ($I_C = 4.5\text{ Adc}$, $I_B = 2\text{ Adc}$)	$V_{CE(sat)}$	—	—	1	Vdc
Base–Emitter Saturation Voltage ($I_C = 4.5\text{ Adc}$, $I_B = 2\text{ Adc}$)	$V_{BE(sat)}$	—	—	1.5	Vdc
DYNAMIC CHARACTERISTICS					
Current–Gain Bandwidth Product ($I_C = 0.1\text{ Adc}$, $V_{CE} = 5\text{ Vdc}$, $f_{test} = 1\text{ MHz}$)	f_T	—	4	—	MHz
Output Capacitance ($V_{CB} = 10\text{ Vdc}$, $I_E = 0$, $f_{test} = 1\text{ MHz}$)	C_{ob}	—	125	—	pF
SWITCHING CHARACTERISTICS					
Storage Time (see test circuit fig. 1) ($I_C = 4.5\text{ Adc}$, $I_{B1} = 1.8\text{ Adc}$, $L_B = 10\text{ }\mu\text{H}$)	t_s	—	8	—	μs
Fall time (see test circuit fig. 1) ($I_C = 4.5\text{ Adc}$, $I_{B1} = 1.8\text{ Adc}$, $L_B = 10\text{ }\mu\text{H}$)	t_f	—	0.4	—	μs

¹Pulse test: PW = 300 μs ; Duty cycle $\leq 2\%$.

BU208A

BASE DRIVE The Key to Performance

By now, the concept of controlling the shape of the turn-off base current is widely accepted and applied in horizontal deflection design. The problem stems from the fact that good saturation of the output device, prior to turn-off, must be assured. This is accomplished by providing more than enough I_{B1} to satisfy the lowest gain output device h_{FE} at the end of scan I_{CM} . Worst-case component variations and maximum high voltage loading must also be taken into account.

If the base of the output transistor is driven by a very low impedance source, the turn-off base current will reverse very quickly as shown in Figure 3. This results in rapid, but only partial collector turn-off, because excess carriers become trapped in the high resistivity collector and the transistor is still conductive. This is a high dissipation mode, since the collector voltage is rising very rapidly. The problem is overcome by adding inductance to the base circuit to slow the base current reversal as shown in Figure 4, thus allowing excess carrier recombination in the collector to occur while the base current is still flowing.

Choosing the right L_B is usually done empirically since the equivalent circuit is complex, and since there are several important variables (I_{CM} , I_{B1} , and h_{FE} at I_{CM}). One method is to plot fall time as a function of L_B , at the desired conditions, for several devices within the h_{FE} specification. A more informative method is to plot power dissipation versus I_{B1} for a range of values of L_B .

This shows the parameter that really matters, dissipation, whether caused by switching or by saturation. For very low L_B a very narrow optimum is obtained. This occurs when $I_{B1} h_{FE} \cong I_{CM}$, and therefore would be acceptable only for the "typical" device with constant I_{CM} . As L_B is increased, the curves become broader and flatter above the $I_{B1} h_{FE} = I_{CM}$ point as the turn off "tails" are brought under control. Eventually, if L_B is raised too far, the dissipation all across the curve will rise, due to poor initiation of switching rather than tailing. Plotting this type of curve family for devices of different h_{FE} , essentially moves the curves to the left, or right according to the relation $I_{B1} h_{FE} = \text{constant}$. It then becomes obvious that, for a specified I_{CM} , an L_B can be chosen which will give low dissipation over a range of h_{FE} and/or I_{B1} . The only remaining decision is to pick I_{B1} high enough to accommodate the lowest h_{FE} part specified. Neither L_B nor I_{B1} are absolutely critical. Due to the high gain of ON Semiconductor devices it is suggested that in general a low value of I_{B1} be used to obtain optimum efficiency — eg. for BU208A with $I_{CM} = 4.5$ A use $I_{B1} \approx 1.5$ A, at $I_{CM} = 4$ A use $I_{B1} \approx 1.2$ A. These values are lower than for most competition devices but practical tests have showed comparable efficiency for ON Semiconductor devices even at the higher level of I_{B1} .

An L_B of 10 μH to 12 μH should give satisfactory operation of BU208A with I_{CM} of 4 to 4.5 A and I_{B1} between 1.2 and 2 A.

TEST CIRCUIT WAVEFORMS

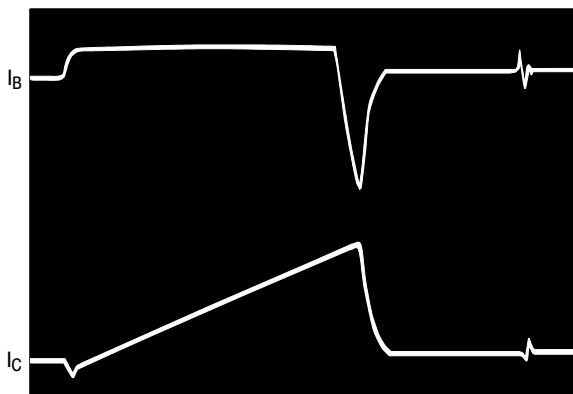

(TIME)
Figure 3.

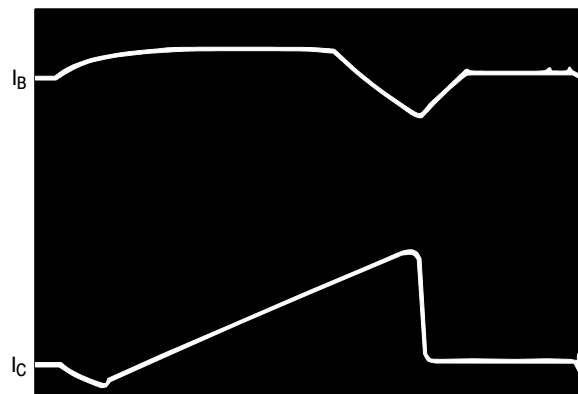

(TIME)
Figure 4.

TEST CIRCUIT OPTIMIZATION

The test circuit may be used to evaluate devices in the conventional manner, i.e., to measure fall time, storage time, and saturation voltage. However, this circuit was designed to evaluate devices by a simple criterion, power supply input. Excessive

power input can be caused by a variety of problems, but it is the dissipation in the transistor that is of fundamental importance. Once the required transistor operating current is determined, fixed circuit values may be selected.

BU208A

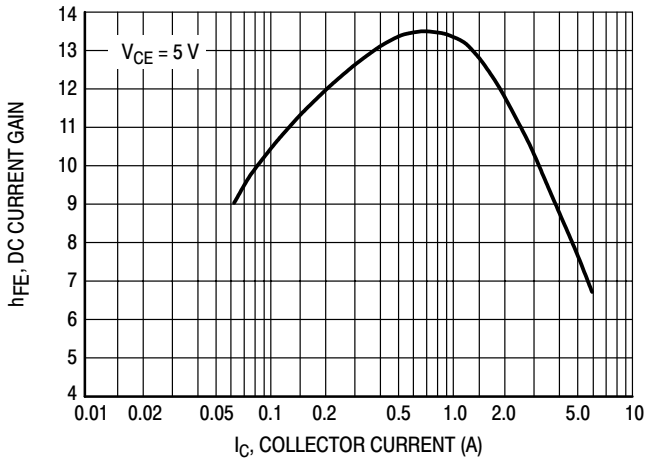

Figure 5. DC Current Gain

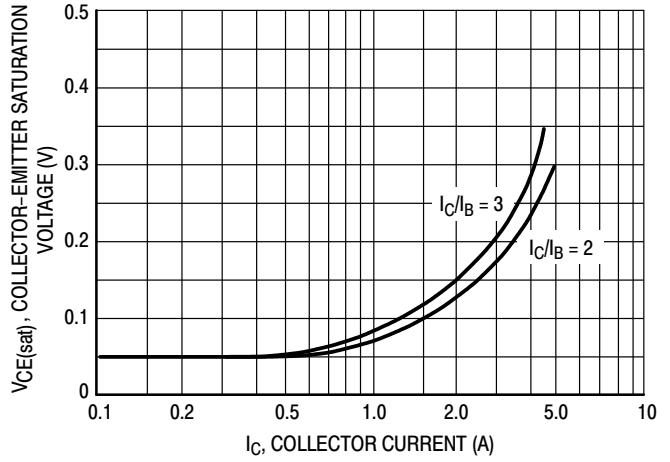

Figure 6. Collector-Emitter Saturation Voltage

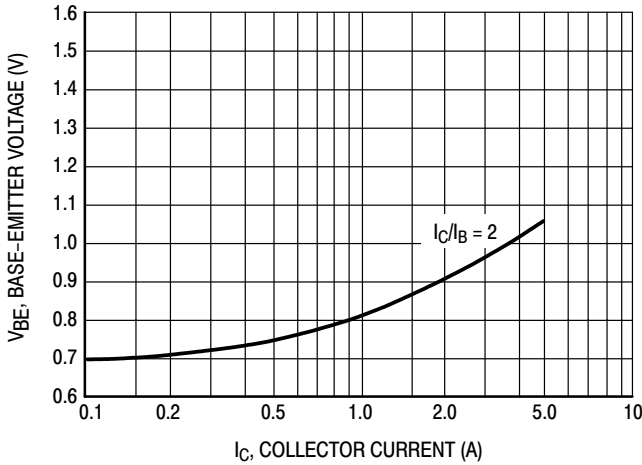

Figure 7. Base-Emitter Saturation Voltage

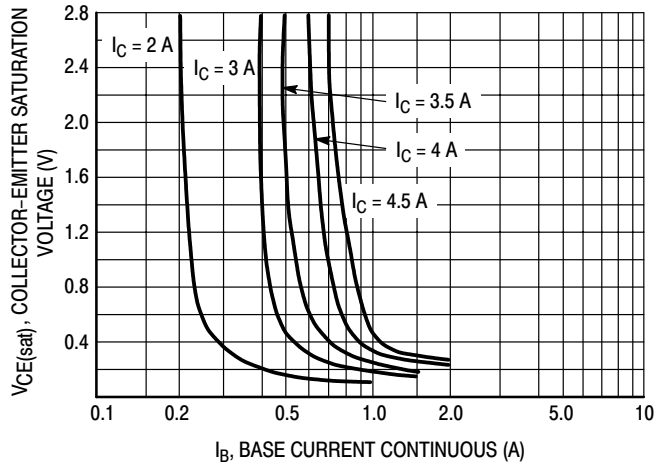

Figure 8. Collector Saturation Region

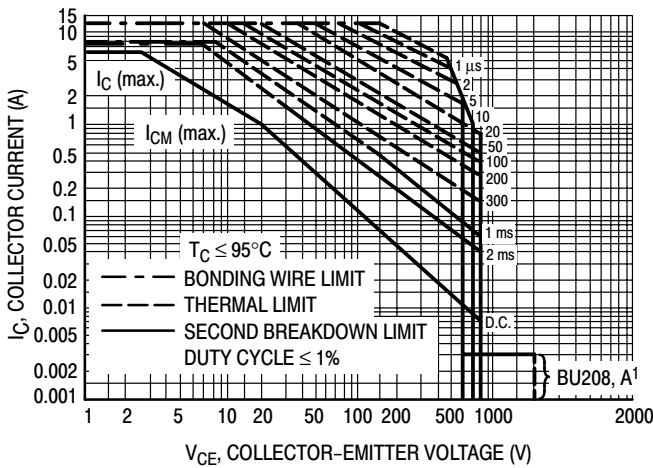

Figure 9. Maximum Forward Bias Safe Operating Area

¹Pulse width $\leq 20 \mu\text{s}$. Duty cycle ≤ 0.25 . $R_{BE} \leq 100 \text{ Ohms}$.

BU208A

PACKAGE DIMENSIONS

CASE 1-07 TO-204AA (TO-3) ISSUE Z

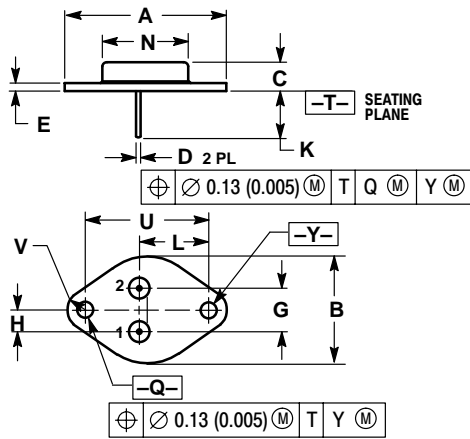

- NOTES:
1. DIMENSIONING AND TOLERANCING PER ANSI Y14.5M, 1982.
 2. CONTROLLING DIMENSION: INCH.
 3. ALL RULES AND NOTES ASSOCIATED WITH REFERENCED TO-204AA OUTLINE SHALL APPLY.

DIM	INCHES		MILLIMETERS	
	MIN	MAX	MIN	MAX
A	---	1.550 REF	---	39.37 REF
B	---	1.050	---	26.67
C	0.250	0.335	6.35	8.51
D	0.038	0.043	0.97	1.09
E	0.055	0.070	1.40	1.77
G	0.430 BSC		10.92 BSC	
H	0.215 BSC		5.46 BSC	
K	0.440	0.480	11.18	12.19
L	0.665 BSC		16.89 BSC	
N	---	0.830	---	21.08
Q	0.151	0.165	3.84	4.19
U	1.187 BSC		30.15 BSC	
V	0.131	0.188	3.33	4.77

- STYLE 1:
PIN 1. BASE
2. EMITTER
CASE: COLLECTOR

Notes

ON Semiconductor and  are trademarks of Semiconductor Components Industries, LLC (SCILLC). SCILLC reserves the right to make changes without further notice to any products herein. SCILLC makes no warranty, representation or guarantee regarding the suitability of its products for any particular purpose, nor does SCILLC assume any liability arising out of the application or use of any product or circuit, and specifically disclaims any and all liability, including without limitation special, consequential or incidental damages. "Typical" parameters which may be provided in SCILLC data sheets and/or specifications can and do vary in different applications and actual performance may vary over time. All operating parameters, including "Typicals" must be validated for each customer application by customer's technical experts. SCILLC does not convey any license under its patent rights nor the rights of others. SCILLC products are not designed, intended, or authorized for use as components in systems intended for surgical implant into the body, or other applications intended to support or sustain life, or for any other application in which the failure of the SCILLC product could create a situation where personal injury or death may occur. Should Buyer purchase or use SCILLC products for any such unintended or unauthorized application, Buyer shall indemnify and hold SCILLC and its officers, employees, subsidiaries, affiliates, and distributors harmless against all claims, costs, damages, and expenses, and reasonable attorney fees arising out of, directly or indirectly, any claim of personal injury or death associated with such unintended or unauthorized use, even if such claim alleges that SCILLC was negligent regarding the design or manufacture of the part. SCILLC is an Equal Opportunity/Affirmative Action Employer.

PUBLICATION ORDERING INFORMATION

NORTH AMERICA Literature Fulfillment:

Literature Distribution Center for ON Semiconductor
P.O. Box 5163, Denver, Colorado 80217 USA
Phone: 303-675-2175 or 800-344-3860 Toll Free USA/Canada
Fax: 303-675-2176 or 800-344-3867 Toll Free USA/Canada
Email: ONlit@hibbertco.com
Fax Response Line: 303-675-2167 or 800-344-3810 Toll Free USA/Canada

N. American Technical Support: 800-282-9855 Toll Free USA/Canada

EUROPE: LDC for ON Semiconductor – European Support

German Phone: (+1) 303-308-7140 (Mon-Fri 2:30pm to 7:00pm CET)
Email: ONlit-german@hibbertco.com
French Phone: (+1) 303-308-7141 (Mon-Fri 2:00pm to 7:00pm CET)
Email: ONlit-french@hibbertco.com
English Phone: (+1) 303-308-7142 (Mon-Fri 12:00pm to 5:00pm GMT)
Email: ONlit@hibbertco.com

EUROPEAN TOLL-FREE ACCESS*: 00-800-4422-3781

*Available from Germany, France, Italy, UK, Ireland

CENTRAL/SOUTH AMERICA:

Spanish Phone: 303-308-7143 (Mon-Fri 8:00am to 5:00pm MST)
Email: ONlit-spanish@hibbertco.com
Toll-Free from Mexico: Dial 01-800-288-2872 for Access –
then Dial 866-297-9322

ASIA/PACIFIC: LDC for ON Semiconductor – Asia Support

Phone: 1-303-675-2121 (Tue-Fri 9:00am to 1:00pm, Hong Kong Time)
Toll Free from Hong Kong & Singapore:
001-800-4422-3781
Email: ONlit-asia@hibbertco.com

JAPAN: ON Semiconductor, Japan Customer Focus Center
4-32-1 Nishi-Gotanda, Shinagawa-ku, Tokyo, Japan 141-0031
Phone: 81-3-5740-2700
Email: r14525@onsemi.com

ON Semiconductor Website: <http://onsemi.com>

For additional information, please contact your local Sales Representative.