

## **Mil-Spec Connectors & Accessories**



PDF.Support

### DEUTSCH ECD

#### **Defense / Aerospace Operations ...**

*is the world's premier manufacturer of electrical interconnection devices for use in defense, aerospace, and commercial applications. Whether you need an interconnection device for a commercial or military aircraft, missile, tank, truck transmission or a host of other applications, Deutsch has the solution you're looking for.*

**Deutsch ECD Defense Aerospace Operations**

5733 W. Whittier Ave., Hemet CA (USA) 92545  
Phone 909/765-2200 • FAX 909/922-1544

# MIL-C-38999 Series I

## DEUTSCH DJT SERIES CONNECTORS

### Cylindrical, High Density Bayonet Coupling Connector Qualified to MIL-C-38999 Series I

The Deutsch Series I version is a long shell, scoop-proof, bayonet coupling connector available in both environment resisting resilient and hermetic types. These Series I connectors are intermateable and interchangeable with all other MIL-C-38999 Series I connectors.

#### Dielectric withstanding voltage:

(Meets MIL-C-38999, paragraph 3.14)  
At sea level: 1800 volts AC (RMS)  
At 100,000 ft.: 200 volts AC (RMS)

#### Insulation resistance:

(Meets MIL-C-38999, paragraph 3.13)  
5000 megohms min. at 25°

#### Thermal shock:

(Meets MIL-C-38999, paragraph 3.8)  
After cycling the connector between -65° C and +175° C, it will meet all applicable electrical and mechanical requirements.

#### Current rating:

(Meets MIL-C-39029, paragraph 1.3.1)  
Contact Size      Max. Amps  
22D                    5  
20                    7.5  
16                    13  
12                    23

#### Temperature:

(Meets MIL-C-38999, paragraph 3.11)  
Operative at temperatures from -65° C to +175° C.

#### Durability:

(Meets MIL-C-38999, paragraph 3.11)  
No electrical or mechanical defects after 500 cycles of engagement and disengagement.

#### Physical shock:

(Meets MIL-C-38999, paragraph 3.27)  
No loosening of parts, cracking or other deleterious results hindering further part operation after 300 G's in each of 3 mutually perpendicular planes.

#### Contact millivolt drop:

22D — 73 millivolts at 5.0 amps  
20 — 55 millivolts at 7.5 amps  
16 — 49 millivolts at 135.0 amps  
12 — 42 millivolts at 23.0 amps

#### Corrosion:

(Meets MIL-C-38999, paragraph 3.16)  
Meets appropriate electrical and mechanical requirements and shows no exposure of base metal after 500 hours of salt spray.

#### Vibration:

(Meets MIL-C-38999, paragraph 3.26)

#### Contact resistance at 25° C:

(Meets MIL-C-39029, paragraph 3.5.4)  
Contact &      Test Current      Millivolt  
Wire Size      (Amps)      Drop (\*)  
22D              5              73  
20              7.5              55  
16              13              49  
12              23              42

#### Usable wire size:

(Meets MIL-C-39029, paragraph 3.4.3.1)  
Contact Size      Accepts (AWG)  
22D              22-28  
20              20-24  
16              16-20  
12              12&14

#### Materials:

Shell — aluminum alloy.  
Pin contacts — copper alloy.  
Inserts — plastic; silicone.

#### Finish:

Shell — O.D. cad over nickel.  
Contacts — gold over nickel.

#### Grommet sealing range:

(Meets MIL-C-39029, paragraph 3.4.3.1)  
Contact      Max. Wire      Min. Wire  
Size      O.D.      O.D.  
22D              .054      .030  
20              .083      .040  
16              .109      .065  
12              .142      .097

#### Fluid compatibility:

(Meets MIL-C-38999, paragraph 3.33)  
Designed to function in all fluids encountered in any modern military or aerospace environment.

#### EMI shielding:

(Meets MIL-C-38999, paragraph 3.31)  
Effective over a range of 100 MHz to 10 GHz with a minimum 50 dB effectiveness at 10 GHz.

Frequency MHz	Leakage attenuation minimum (dB)
100	90
200	88
300	87
400	85
800	85
1,000	85
1,500	69
2,000	65
3,000	61
4,000	58
6,000	55
10,000	50

#### Fluid immersion:

Fluid resistant to many fuels, coolants and solvents per MIL-C-38999.

This information is for reference only. Consult factory for envelope drawings, updated specifications, and additions to the product line.



SHELL SIZE	H DIA. REF.	SHELL SIZE	KEY POSITION $\alpha$				
			H	A	B	C	D
09	.568	09	95°	77°	---	---	113°
11	.696	11	95°	81°	67°	123°	109°
13	.846	13	95°	75°	63°	127°	115°
15	.971	15	95°	74°	61°	129°	116°
17	1.096	17	95°	77°	65°	125°	113°
19	1.203	19	95°	77°	65°	125°	113°
21	1.328	21	95°	77°	65°	125°	113°
23	1.453	23	95°	80°	69°	121°	110°
25	1.578	25	95°	80°	69°	121°	110°

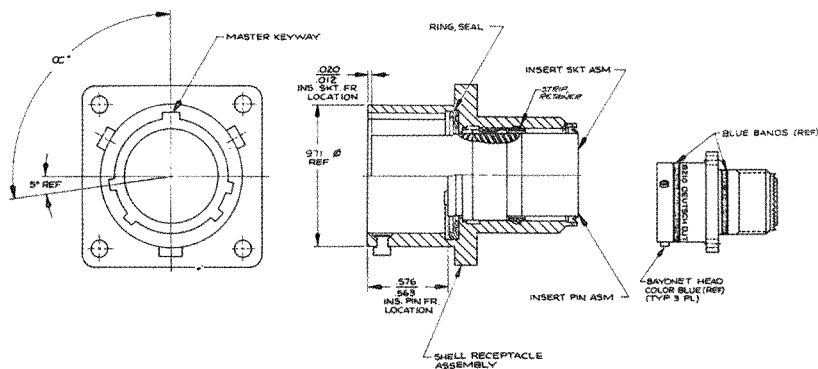

This information is for reference only. Consult factory for envelope drawings, updated specifications, and additions to the product line.



Receptacle Outline Dimensions



Plug Outline Dimensions



SHELL SIZE	A ± .020	B ± .005	C0 ± .003	D THREAD UNEF-2A	E0 + .010 - .005	F0 MIN.	G0 ± .005	H MAX.	J + .000 - .005	A0 MAX	B THREAD UNEF-2A
9	.938	.719	.570	.4375-28	.128	.516	.128	.100	.632	.859	.4375-28
11	1.031	.812	.698	.5625-24	.128	.664	.128	.100	.632	.984	.5625-24
13	1.125	.906	.848	.6875-24	.128	.750	.128	.100	.632	1.156	.6875-24
15	1.219	.969	.973	.8125-20	.128	.906	.128	.100	.632	1.281	.8125-20
17	1.312	1.062	1.098	.9375-20	.128	1.016	.128	.100	.632	1.406	.9375-20
19	1.438	1.156	1.205	1.0625-18	.128	1.141	.128	.100	.632	1.516	1.0625-18
21	1.562	1.250	1.330	1.1875-18	.128	1.266	.128	.130	.602	1.641	1.1875-18
23	1.688	1.375	1.455	1.3125-18	.147	1.377	.154	.130	.602	1.766	1.3125-18
25	1.812	1.500	1.580	1.4375-18	.147	1.484	.154	.130	.602	1.891	1.4375-18

This information is for reference only. Consult factory for envelope drawings, updated specifications, and additions to the product line.



# DJT Series Insert Arrangements

## Contact Arrangements



## Deutsch Shell Sizes

DJT	Service Rating	Total Contacts	Contact Size			
			22D	20	16	12
9-35	M	6	6			
9-98	I	3		3		
11-5	I	5		5		
11-35	M	13	13			
11-99	I	7		7		
13-4	I	4			4	
13-35	M	22	22			
13-98	I	10		10		
15-5	II	5			5	
15-18	I	18			18	
15-35	M	37	37			
15-97	I	12		8	4	
17-6	I	6				6
17-8	II	8			8	
17-26	I	26		26		
17-35	M	55	55			
19-11	II	11				11
19-32	I	32		32		
19-35	M	66	66			
21-11	I	11				11
21-16	II	16			16	
21-41	I	41		41		
21-35	M	79	79			
23-21	II	21			21	
23-53	I	53		53		
23-55	I	55		55		
25-4	I	56		48	8	
25-19	I	19				19
25-24	I	24				12 12
25-29	I	29			29	
25-35	M	128	128			
25-61	I	61		61		



This information is for reference only. Consult factory for envelope drawings, updated specifications, and additions to the product line.





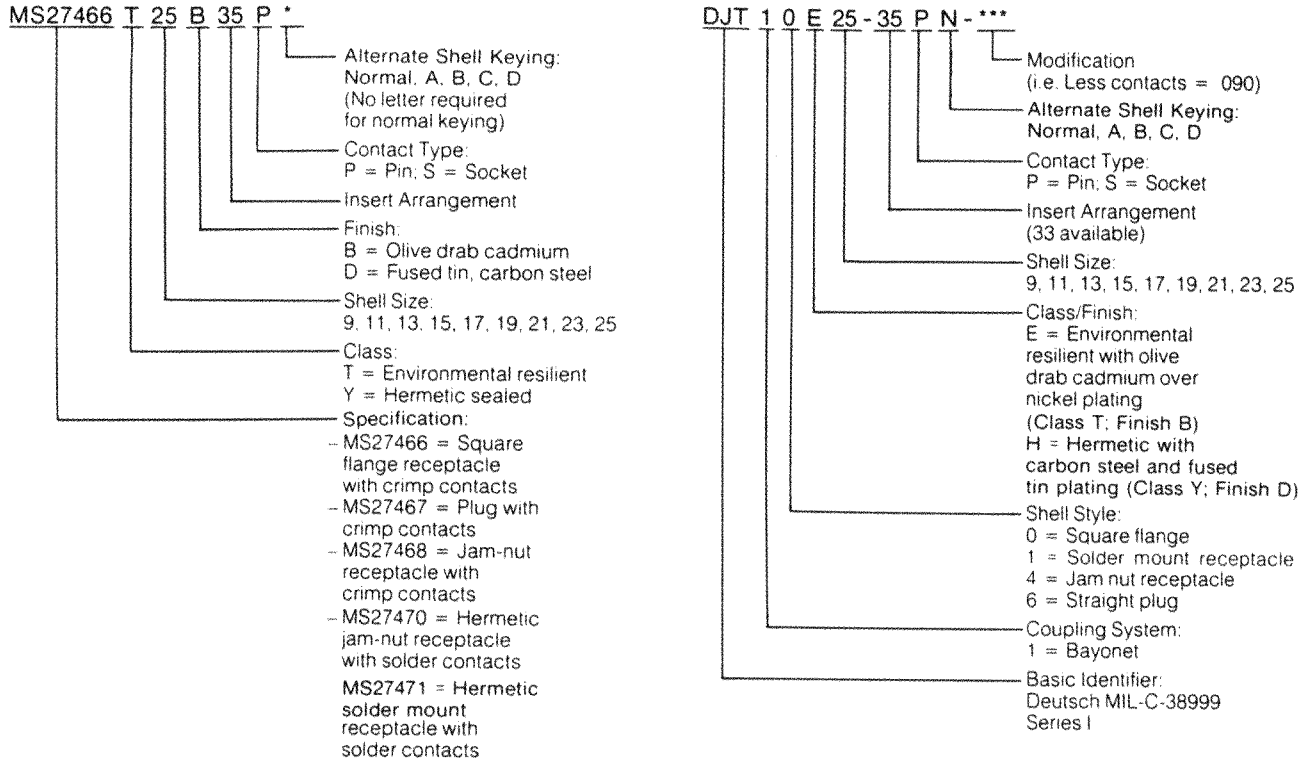

# Part Number Cross Reference

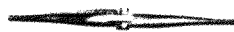

## Assembly Tools

Wire/contact assembly tools are standard military type insertion/removal tools found in most assembly areas.

- Yellow  Size 22D
- Red  Size 20
- Blue  Size 16
- Yellow  Size 12

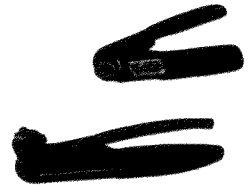

Contact Size	Insertion/removal tool	Crimp tool	Crimp tool positioner	Sealing plug (Military P/N)
22D	M81969 14-01 MS3160-23	M22520/7-01	M22520/7-07 M22520-7/05	MS27488-22
20	M81969 14-02	M22520/1-01	M22520/1-04	MS27488-20
16	M81969 14-03	M22520/1-01	M22520/1-04	MS27488-15
12	M81969 14-04	M22520/1-01	M22520/1-04	MS27488-12

This information is for reference only. Consult factory for envelope drawings, updated specifications, and additions to the product line.



# Mouser Electronics

Authorized Distributor

Click to View Pricing, Inventory, Delivery & Lifecycle Information:

## TE Connectivity:

[MS27466T13B35SA](#) [MS27467T21F16A](#) [DJT14E17-8SB](#) [DJT16E11-99HB-LC](#) [DJT10E9-35HN](#) [DJT10F23-55HN](#)  
[DJT10E11-99BB](#) [DJT10F17-6PB-LC](#) [DJT10F13-4PC-LC](#) [DJT14E17-26AA](#) [DJT16E11-98SC](#) [DJT10E15-97HA](#)  
[DJT14E17-26JA-LC](#) [DJT14E11-98PN](#) [DJT14E21-41BN](#) [DJT10F23-21AN](#) [DJT10F25-4PA](#) [DJT10E21-35PN](#)  
[DJT16F11-98HA-LC](#) [DJT16E17-8PC-LC](#) [DJT10F13-4HC](#) [DJT10E17-8BB](#) [DJT14F15-97HA-LC](#) [DJT10E9-98JA-LC](#)  
[DJT16F21-16HC](#) [DJT14F19-11PB](#) [DJT16E13-98BN](#) [DJT16E23-53BC](#) [DJT16F13-98AA](#) [DJT16E17-8JA](#) [DJT10E23-55HB-LC](#)  
[DJT10E25-19SB-LC](#) [DJT16E15-5SC](#) [DJT14F23-55AN](#) [DJT10E15-35SN](#) [DJT10E19-35AC](#) [DJT16F23-55PA](#)  
[DJT10F23-55BN](#) [DJT10F13-35SB-LC](#) [DJT16E17-35HC-LC](#) [DJT14E15-5SA](#) [DJT16F23-55SA](#) [DJT16E15-97PA](#)  
[DJT16F17-26SN-LC](#) [DJT10F11-99PN-LC](#) [DJT14E15-35SN](#) [DJT14F25-19SB-LC](#) [DJT10E21-35JC-LC](#)  
[DJT16E21-16SN-LC](#) [DJT10F17-6HA-LC](#) [DJT14F21-41HA](#) [DJT10F15-18SN](#) [DJT14E19-32HN-LC](#) [DJT10E17-6HN-LC](#)  
[DJT16F17-35HC-LC](#) [DJT10F25-4HC](#) [DJT10E21-35PN-LC](#) [DJT10F25-29PB](#) [DJT10F15-18JC](#) [DJT10F13-35JC-LC](#)  
[DJT16E13-35PN](#) [DJT16E23-55SA](#) [DJT16F11-5AB](#) [DJT16F19-32PA](#) [DJT14E25-19SB-LC](#) [DJT14E23-21BB](#)  
[DJT14E23-21JN](#) [DJT16F17-8SN](#) [DJT16F15-97HN-LC](#) [DJT16F17-35HA](#) [DJT10E19-11HB-LC](#) [DJT10E21-11HC](#)  
[DJT16E21-41SA](#) [DJT10E11-98PA-LC](#) [DJT14E17-8HB-LC](#) [DJT16F19-32JC-LC](#) [DJT16E13-98PC](#) [DJT14F17-35AN](#)  
[DJT14E15-5PN-LC](#) [DJT14E25-4JB-LC](#) [DJT16E13-35PA](#) [DJT16F15-97SC-LC](#) [DJT16E15-97JN-LC](#) [DJT10E13-4HB](#)  
[DJT10F17-6SB](#) [DJT10E15-97JN-LC](#) [DJT16F11-5JB-LC](#) [DJT14E11-99JA](#) [DJT10F25-4SC](#) [DJT10E15-5PN-LC](#)  
[DJT10F15-97PC](#) [DJT10E17-8JC](#) [DJT14F15-5JA](#) [DJT10E13-98PA](#) [DJT16E21-35HN-LC](#) [DJT10F25-35PC-LC](#)  
[DJT10E25-29JC](#) [DJT10E21-35SN](#) [DJT14F21-41SB](#) [DJT16F11-98SN](#)