

STEP MOTORS

POWERPLUS

ENCAPSULATED

2 PHASE 0.9° HYBRID

2 PHASE 1.8° HYBRID

3 PHASE 1.2° HYBRID

PDF.Support

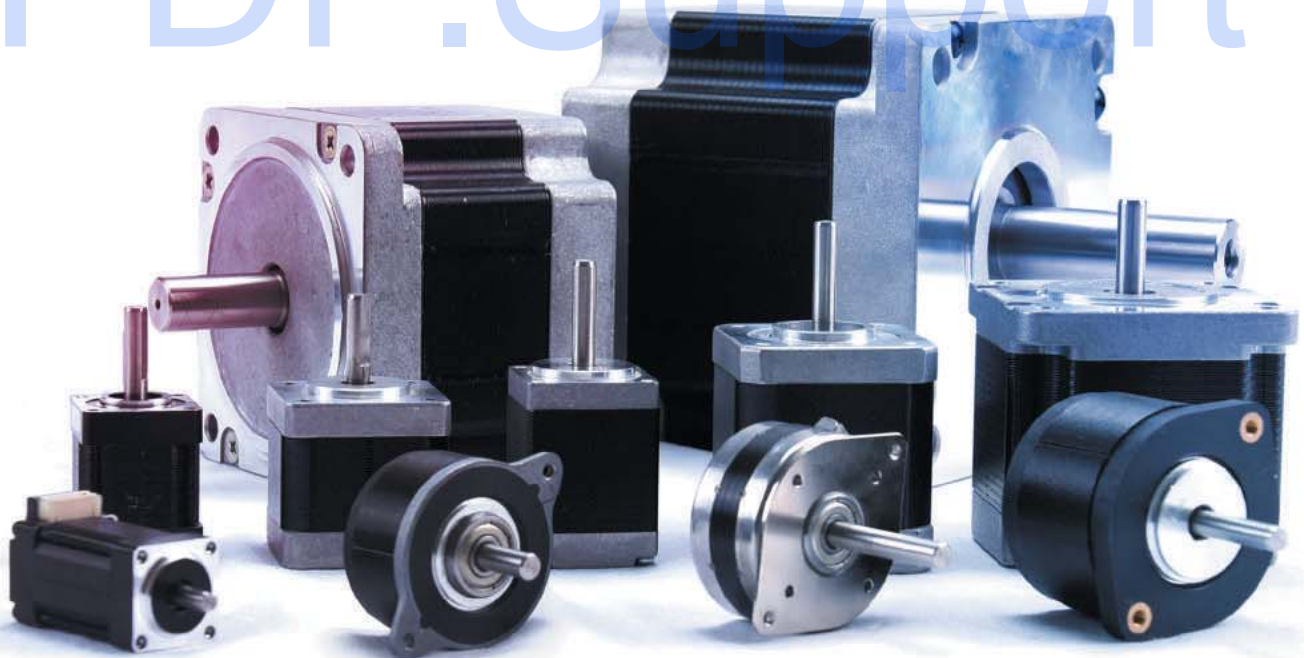

MOONS'
moving in better ways

STEP MOTORS

Contents

MOONS' Technology	PowerPlus Technology.....03 MOONS' Step Motor Advantages.....04 Encapsulated Motors.....05 2 Phase and 3 Phase Motors..... 06	MOONS' Technology
	Model Number System.....07 Custom Motors..... 08	
2 Phase Step Motors	Size 8 - 1.8° - MS08HY Series..... 09 Size 10 - 1.8° - MS10HY Series..... 11 Size 11 - 1.8° - MS11HS Series..... 13 Size 14 - 0.9° - 14HK Encapsulated Series.....17 Size 14 - 0.9° - MS14HA Series..... 19 Size 14 - 1.8° - MS14HS Series..... 23 Size 16 - 1.8° - MS16HR Series..... 27 Size 16 - 1.8° - MS16HS Series..... 29 Size 17 - 0.9° - MS17HA Series..... 33 Size 17 - 1.8° - MS17HD Series..... 37 Size 23 - 0.9° - MS23HA Series..... 41 Size 23 - 1.8° - ML23HS / PL23HS -High torque / PowerPlus Series... 43 Size 24 - 1.8° - MS24HS Series..... 47 Size 34 - 1.8° - ML34HD / PL34HD - High torque / PowerPlus Series..49 Size 42 - 1.8° - ML42HS Series.....53	2 Phase Step Motors
3 Phase Step Motors	Size 17 - 1.2° - 17HC Encapsulated Series.....55 Size 24 - 1.2° - ML24HC / PL24HC - High torque / PowerPlus Series..57 Size 34 - 1.2° - 34HC Series..... 61	3 Phase Step Motors
Technical	Step Motor Basics - Applications, Structure & Operation..... 63 Load Calculations & Tips for Using Step Motors..... 65 Step Sequence & Schematic Diagrams.....67 Bearing Life & Shaft Loading.....68 Conversion Factors..... 69	Technical

PowerPlus Technology

MOONS' PowerPlus technology provides 25% to 40% more torque across the entire speed range of the motor. The increased torque is a result of higher motor efficiency, and is available without increasing the drive voltage or current.

■ Typical Applications:

Machine Upgrades: Changing existing machines to PowerPlus motors can be a quick path to new models with improved performance. Because the motor, drive and mechanical parts remain the same, benefits include:

- Faster new product introduction
- Reduced engineering costs
- Easy production phase in
- Reduced spare parts inventory

Correct stalling problems with existing machines:

Problems with occasional machine stalling are often due to unexpected field conditions such as: low temperature, dirt, and customers using machines in unexpected ways. Using PowerPlus motors can be a quick effective solution.

Overcome drive or power supply limitations in new designs:

Often a higher current drive or higher voltage power supply can provide needed extra torque. However, in many designs the drive current cannot be increased without changing to a substantially more expensive drive. And increasing drive voltage can be impractical, expensive, or may not be allowed for safety reasons. In these cases using PowerPlus motors can be especially useful.

Conventional Motor

Some of the torque producing magnetic flux that links the rotor to the stator is outside the stator teeth. This stray flux adds little to motor torque.

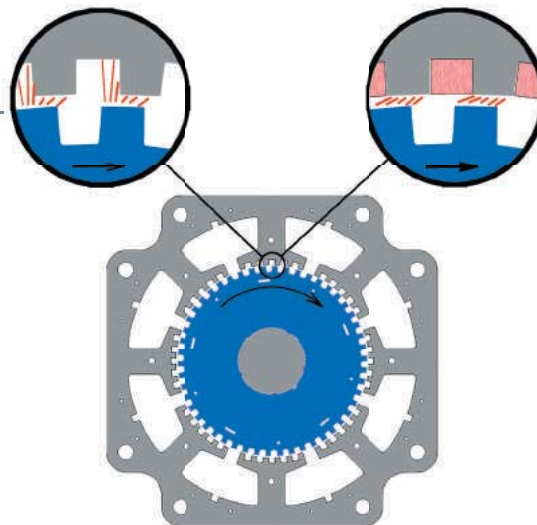

PowerPlus Technology

Magnets placed between the stator teeth redirect most of the stray magnetic flux into the stator teeth. This produces additional torque with the same input power.

MOONS' Step Motor Advantages

These step motors from MOONS' include a number of improvements for even greater performance and value:

- Many refinements that increase torque by an average of 20%
- Complete range of sizes: 8, 10, 11, 14, 16, 17, 23, 24, 34, 42
- Size 17 and larger 2 phase motors are UL recognized
- 0.9 degree 2 phase motors, and 3 phase motors for extra smooth, quiet, performance
- PowerPlus technology: for maximum efficiency and performance at all speeds
- Lower inertia rotors provide faster acceleration
- High voltage insulation for use with high voltage, high performance drives
- Low loss stators have better high speed performance
- Standard windings with high fill for more torque
- Updated model numbering system includes a wider range of windings and standard options

Rare earth magnets and optimized rotors designed for maximum torque, and high efficiency

Laminations optimized for high torque, high accuracy and low losses.

Stators with maximum winding fill for lower temperatures, long life and maximum torque

Connectors integrated into motors for quick reliable connections.

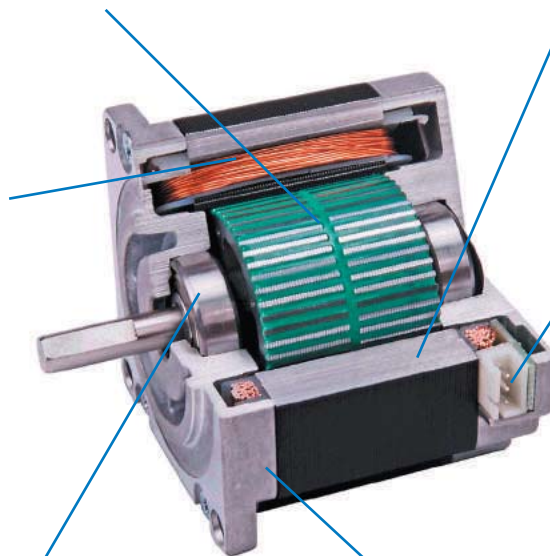

Large ball bearings, also optimized for short repetitive moves to ensure long life.

Die cast endbells provide strength, precision, and help cool the motor.

Encapsulated Motors

Encapsulation Technology From MOONS' Offers Many Advantages

Ideal for Security Cameras

In addition to all the advantages of normal step motors, these new encapsulated motors can help achieve a breakthrough in miniaturization of security cameras. Small step motors are a core component in security camera systems. With MOONS' encapsulation technology, the 36mm diameter motor is now available with a thickness as little as 12.8mm.

Low Temperature Rise

The winding resistance of these new motors is nearly 30% lower than other motors with the same thickness and output-torque. In addition, the new encapsulation technology increases the heat-conducting property of these motors. The lower winding resistance and improved thermal conductivity combine to drastically lower the temperature of these motors to less than 80% of standard motors.

35% More Torque

Lower resistance coils allows these encapsulated motors to handle more power. With the same temperature rise. These motors can produce 35% more torque.

Quieter & Smoother

New materials and improved manufacturing processes, means these motors have a higher precision, more stable design. This controls vibration and reduces noise. It also makes the motor run smoothly.

More Load & Longer Life

MOONS' encapsulated stepping motors use large bearings that can handle large axial and radial loads, ensure long life.

RoHS

Encapsulated stepping motors are RoHS compliant.

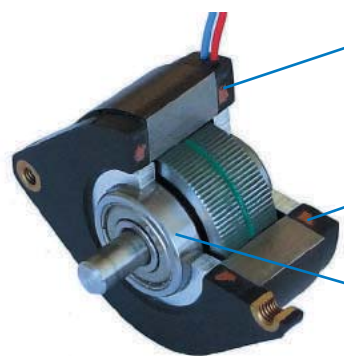
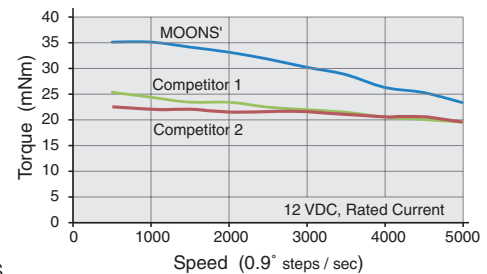

Molded Construction

Encapsulated winding
Better sealing
Reduced vibration

Runs cooler – Longer life
Longer life
Smoother moves - Quieter

High Winding Fill

Larger wire size
Uses less energy

More torque
Longer battery life

Large Ball Bearings

Large shaft loads
Long Life

Fewer design restrictions
27 times with the same load

2 Phase and 3 Phase Motors

MOONS' offers several families of hybrid step motors with a different number of phases and step angles. Each has a combination of advantages that are better suited to specific applications.

- **2 Phase - 1.8 degree step angle**

This is the most popular step motor. It has a great combination of torque, speed and accuracy. Due to their high volumes, drives for 2 phase motors are very common and economical.

The basic method of control is to have the motor make one full step as the drive applies full current to the motor windings. This causes the motor to move in full step increments. When the motor is stepped at different rates it may make a distinctive sound and can vibrate (resonate) at certain speeds. This is not a problem for most applications. If it is an issue, motors can be controlled with micro-stepping drives that smooth motor torque. And many times, resonate speeds can simply be avoided by programming the drive.

MOONS' offers 2 phase 0.9 degree step motors, and three phase 1.2 degree step motors, for applications that need even more accuracy, or motion that is very smooth and quiet.

- **2 Phase - 0.9 degree step angle**

Because each step moves only $\frac{1}{2}$ the distance of 1.8 degree motors, these motors have higher accuracy and very smooth movement. The drive for this motor is exactly the same as the 2 phase, 1.8 degree motors. For the same speed, these motors must have a step rate that is 2 times that of a 1.8 degree motor. This higher step rate leads to less torque at high speeds. However, for many applications high speed is not needed, or higher voltage drives can be used to increase torque at high speeds.



14HK0 Shown Full Size

An example of a good application for 0.9 degree motors are security cameras. These motors allow the camera to be precisely moved without "camera shake" which causes the picture to vibrate. MOONS' offers small encapsulated sizes that reduce camera package size, and helps withstand the outdoor environment.

- **3 Phase - 1.2 degree step angle**

The use of three phases inherently helps to reduce torque ripple and smooth motor performance. 3 phase motors require a 3 phase drive that is different than the drive for 2 phase motors. As compared to the 1.8 degree two phase motors, the low speed torque is somewhat less. But design improvements introduced by MOONS', minimizes this difference. High speed torque can also be comparable. In addition, MOONS' size 24 three phase motors are available with PowerPlus technology, for maximum torque.

3 phase motors are used where maximum performance, and very quiet, smooth precise movement is needed. An example of a good application for three phase motors is in performance lighting. These spotlights need quick movement, and quiet operation so as not to disturb the performance.

Model Numbering System

Models starting with M or P **M** **S** **17** **HD** **2** **P** **4** **040** **-M**

Stator - Series

M Standard Step Motor
P PowerPlus Step Motor

Rotor

S Standard Inertia Size 8, 10, 11, 14, 16, 17, 23, 24
L Lower Inertia Size 23, 24, 34, 42

Frame Size

08, 10, 11, 14, 16, 17, 23, 24, 34, 42

Motor Technology

HA Hybrid Step Motor, 2 Phase 0.9 degree
HY, HD, HS, HR Hybrid Step Motor, 2 Phase 1.8 degree
HC Hybrid Step Motor, 3 Phase 1.2 degree

Length Code

Non significant number or letter

Connection Construction / IP Rating

L Leads IP40
P, F, R Plug In Connector - Standard IP40

Number of connections / Winding Type

4 Bipolar
6 Unipolar (can be used bipolar)
8 Can be connected any way

Winding Current

Current rating x 100. 050 = 0.5 amps, 500 = 5 amps
X## for 11 to 19 amps: X10= 11 amps, X40 = 14 amps

Options

Omit No Options
-E Standard English rear shaft
-M Standard Metric rear shaft

Other Models - 14HK, 17HC & 34HC

14 **HK** **0** **4** **05** **N**

Frame Size

14, 17, 34

Motor Technology

HK 2 Phase 0.9 degree
HC Hybrid Step Motor, 3 Phase 1.2 degree

Length Code

Non significant number or letter

Connection Construction / IP Rating

0 Plug In Connector - Standard IP40
3, 4, 8 Number of Leads IP40

Winding Current

Non significant number

Optional Construction Code

-##
N

Custom Motors

MOONS' provides motors to meet the needs of many applications. Common modifications include:

- Corrosion resistant motors. These are often used in outdoor equipment where humidity and temperature changes can cause corrosion.
- Sealed motors to keep out dust and water
- Special shaft sizes and features
- Pulleys, gears and couplings mounted on the shaft
- Encoders and other feedback devices
- Special lead lengths or cables, with many different connectors

Press Fit Pulley & Gear



Metal Pulley



Plastic Pulley

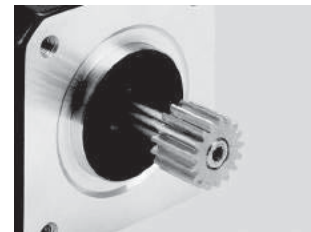

Gear

Shaft Options

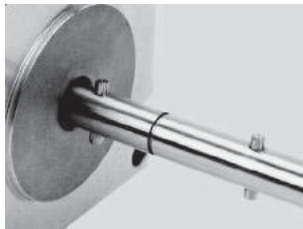

Dowel

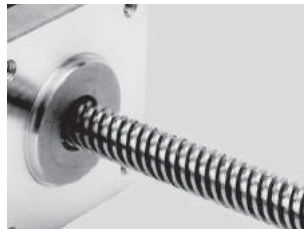

Worm Shaft



Cross Drilled Shaft



Single Flat



Double Flat

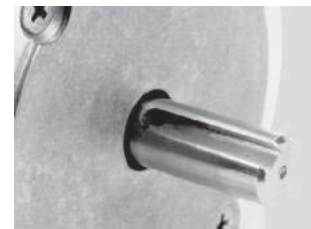

Key Way

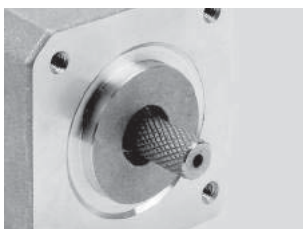

Knurl

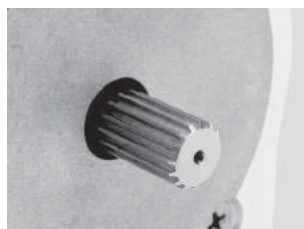

Hobbed Gear

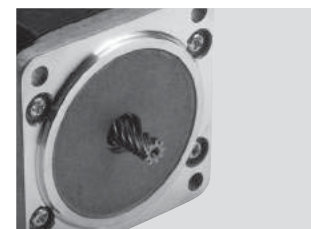

Helical Cut

MS08HY Series: 1.8° - Size 8



- Phases 2
- Steps / Revolution 200
- Step Accuracy ±5%
- Shaft Load (20,000 Hours at 1000 RPM)
 - Axial 6 N (1.3 Lbs.) Push
25 N (5.6 Lbs.) Pull
 - Radial 18 N (4 Lbs.) At End of Shaft
- IP Rating 40
- Approvals RoHS
- Operating Temp. -20°C to +50°C
- Insulation Class B, 130°C
- Insulation Resistance 100 MegOhms

MS08HY 3 P 4 065

Basic Motor Length (Max)

1	29.5mm(1.16in.)
3	39.5mm(1.56in.)
5	46.5mm(1.83in.)

Electrical Connection

- P Plug-In Connector(Side Facing)
- F Font Facing Connector
- R Rear Facing Connector

Winding

Current rating x 100

Number of Connections

- 4 4 Lead-Bipolar
- 6 6 Lead-Unipolar (or Bipolar)

Dimensions: mm (in)

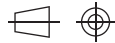

Mating Connector with 4 Leads: 300 (12) long (order separately) Part Number: 4634 1402 03659

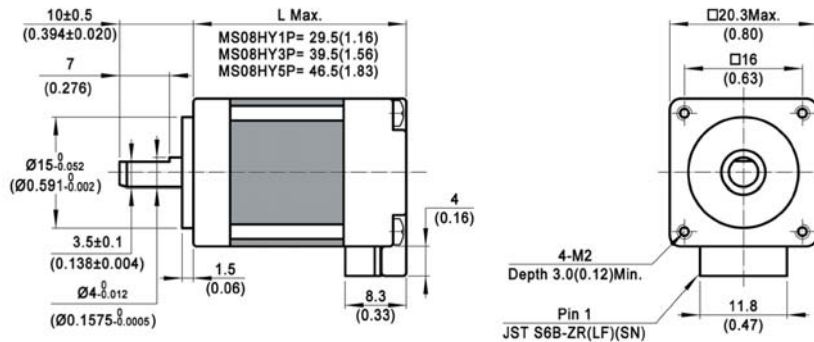

Motor with side facing "P" Plug

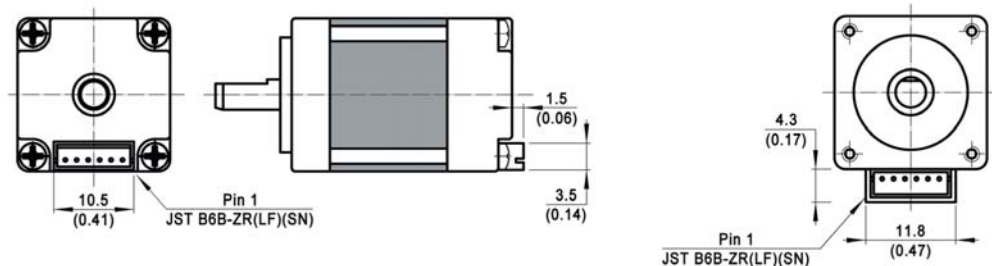

Rear facing "R" connector detail

Font facing "F" connector detail

MS08HY - 4 Lead Bi-Polar

Length	Model Number	Connect	Rated Current	Holding Torque		Winding Ohms mH		Detent Torque		Rotor Inertia		Motor Weight	
				Amps (mounted)	Nm Typ.	oz-in TYP.	@20 C	Typ.	mNm	oz-in	g cm ²	oz-in ²	kg
29.5mm (1.16in.)	MS08HY1P4021	P	0.21	0.028	4.0	45	21						
	MS08HY1P4050	P	0.5	0.030	4.2	8.8	4.7	1.5	0.21	1.6	0.0088	0.04	0.088
	MS08HY1P4070	P	0.7	0.030	4.2	4.5	2.3						
	MS08HY1P4100	P	1	0.030	4.2	2.3	1.17						
39.5mm (1.56in.)	MS08HY3P4027	P	0.27	0.048	6.8	35	18.8						
	MS08HY3P4045	P	0.45	0.050	7.1	13.1	7.6	2	0.28	2.9	0.016	0.06	0.13
	MS08HY3P4065	P	0.65	0.050	7.1	6.6	3.6						
	MS08HY3P4090	P	0.9	0.050	7.1	3.4	1.91						
46.5mm (1.83in.)	MS08HY5P4028	P	0.28	0.057	8.1	34	24						
	MS08HY5P4040	P	0.4	0.057	8.1	16.4	12	2.5	0.35	4.2	0.023	0.08	0.18
	MS08HY5P4060	P	0.6	0.057	8.1	8.2	5.6						
	MS08HY5P4090	P	0.9	0.057	8.1	3.7	2.4						

^ Preferred model

MS08HY1-Bipolar

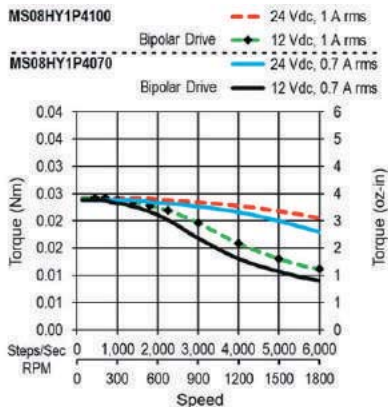
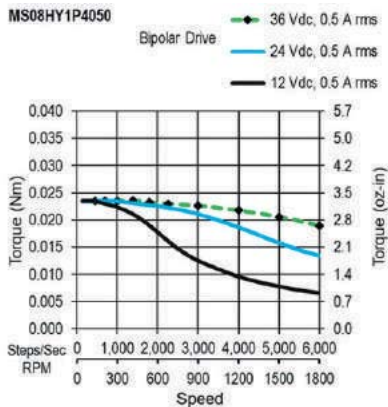
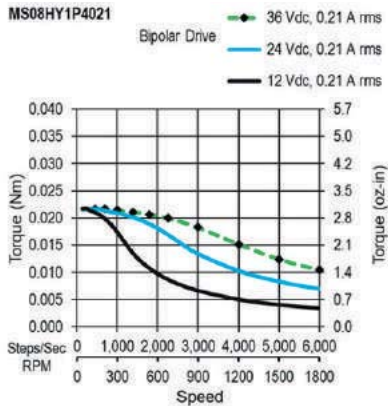

MS08HY3-Bipolar

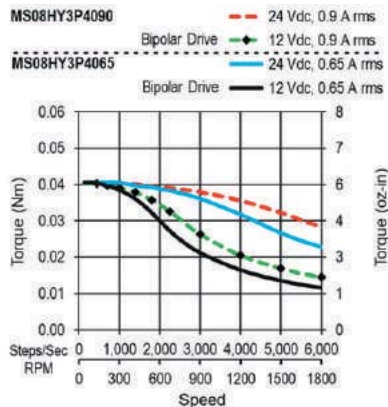
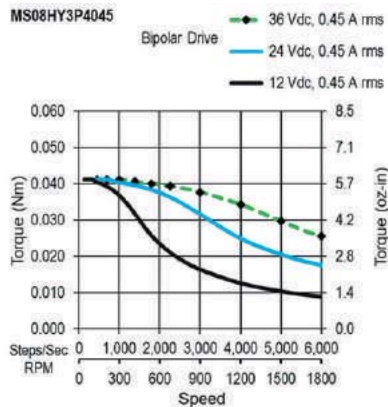
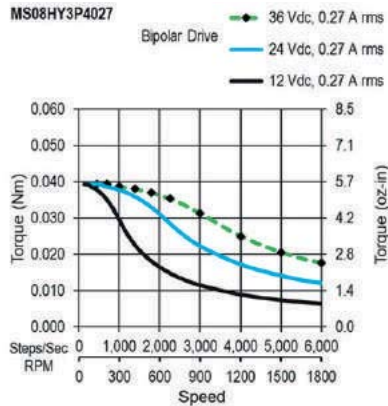

MS08HY5-Bipolar

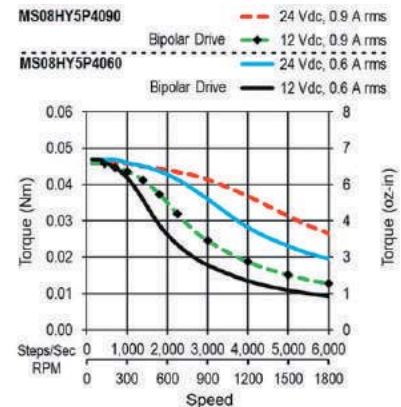
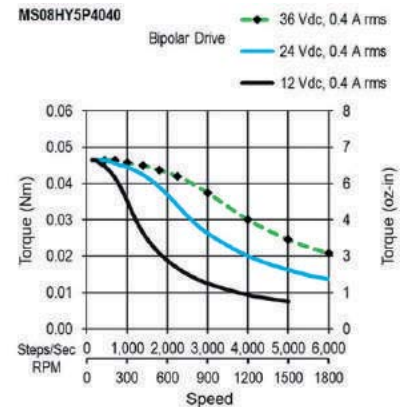
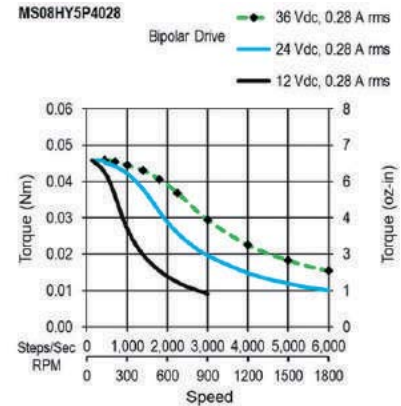

MS10HY Series: 1.8° - Size 10



- Phases 2
- Steps / Revolution 200
- Step Accuracy ±5%
- Shaft Load (20,000 Hours at 1000 RPM)
 - Axial 15 N (3.4 Lbs.) Push
25 N (5.6 Lbs.) Pull
 - Radial 30 N (6.5 Lbs.) At Flat of Shaft
- IP Rating 40
- Approvals RoHS
- Operating Temp. -20°C to +50°C
- Insulation Class B, 130°C
- Insulation Resistance 100 MegOhms

MS10HY 2 F 4 052

Basic Motor Length (Max)

- 0 23.5mm(0.92in.)
- 2 33mm(1.3in.)

Electrical Connection

F Front Facing Connector

Winding

Current rating x 100

Number of Connections

- 4 4 Lead-Bipolar
- 6 6 Lead-Unipolar (or Bipolar)

MS10HY - 4 Lead Bi-Polar

Length	Model Number	Connect P=Side Plug L=Leads	Rated Current Amps (mounted)	Holding Torque		Winding		Detent Torque		Rotor Inertia		Motor Weight	
				Nm Typ.	oz-in TYP.	@20°C	Typ.	mNm	oz-in	g cm ²	oz-in ²	kg	Lbs
23.5 mm (0.92 in.)	MS10HY0F4025	F	0.25	0.045	6.4	44	29	2.5	0.35	2	0.011	0.05	0.11
	MS10HY0F4040	F	0.4	0.045	6.4	16.9	11.5						
	MS10HY0F4060	F	0.6	0.045	6.4	6.9	5.1						
	MS10HY0F4090	F	0.9	0.045	6.4	3.1	2.2						
33 mm (1.3 in.)	MS10HY2F4029	F	0.29	0.086	12.0	37	40	3.5	0.5	5	0.027	0.085	0.19
	MS10HY2F4052	F	0.52	0.086	12.0	11	12.8						
	MS10HY2F4070	F	0.7	0.086	12.0	6	6.9						
	MS10HY2F4100	F	1	0.086	12.0	3	3.5						

Dimensions: mm (in)

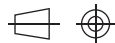

Mating Connector with 4 Leads: 300 (12) long
(order separately) Part Number: 4634 1402 07814

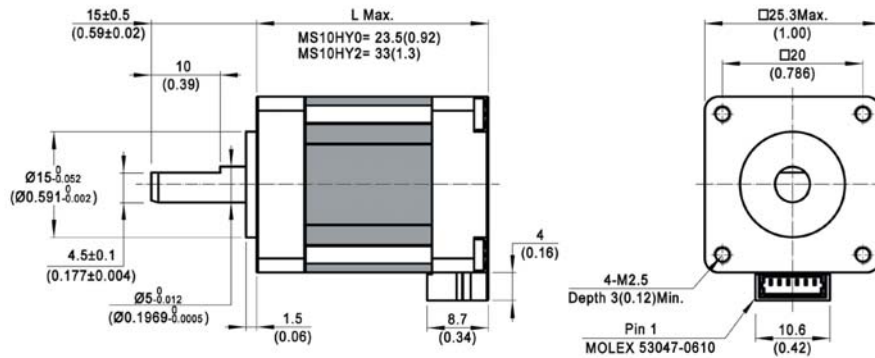

MS10HY0-Bipolar

MS10HY2-Bipolar

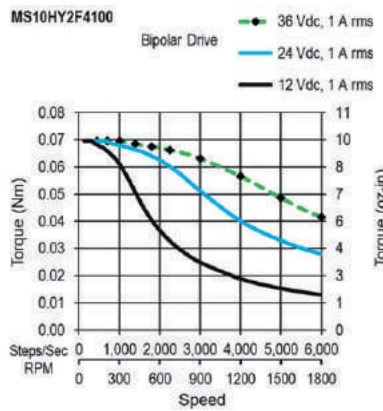
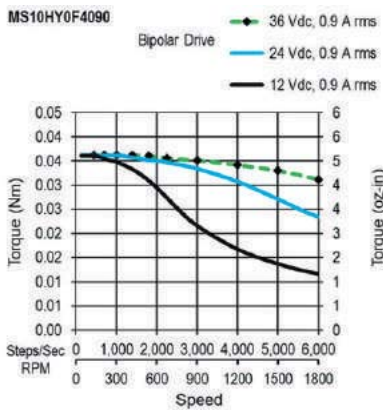
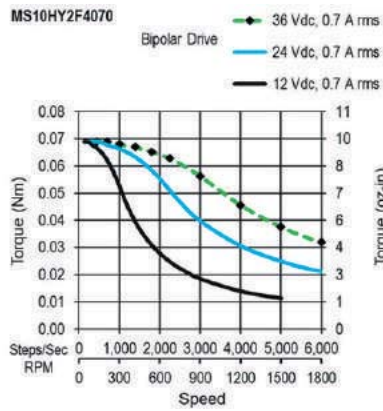
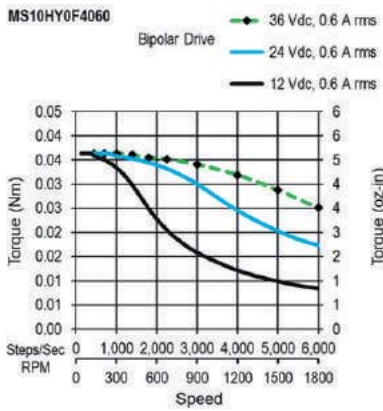
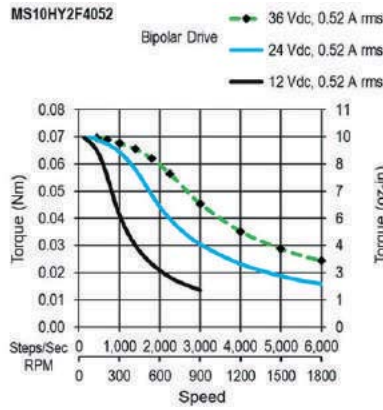
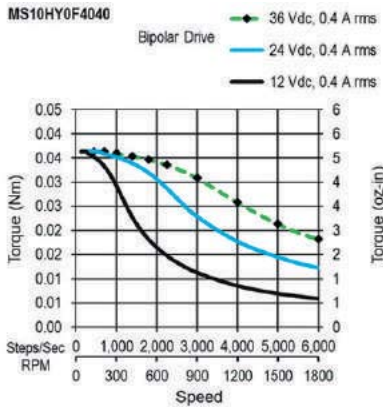
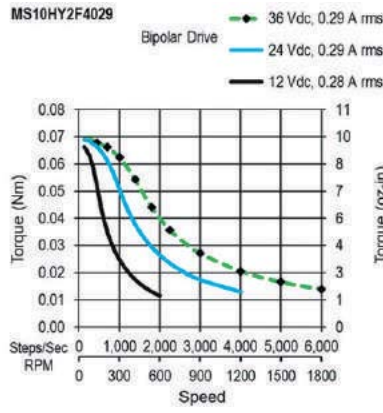
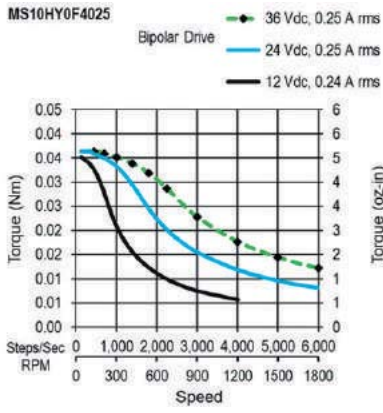

MS11HS - 4 Lead Bi-Polar

Length	Model Number	Connect	Rated Current	Holding Torque		Winding Ohms mH		Detent Torque		Rotor Inertia		Motor Weight	
	Single Shaft	P=Side Plug L=Leads	Amps (mounted)	Nm Typ.	oz-in TYP.	@20 C	Typ.	mNm	oz-in	g cm ²	oz-in ²	kg	Lbs
32 mm (1.26 in.)	MS11HS1P4024	P	0.24	0.09	13	49	38						
	^ MS11HS1P4050	P	0.5	0.09	13	10.9	9.6						
	^ MS11HS1P4067	P	0.67	0.09	13	6.1	5.4	5	0.71	9	0.049	0.1	0.22
	^ MS11HS1P4100	P	1	0.09	13	2.7	2.5						
41 mm (1.61 in.)	MS11HS3P4029	P	0.29	0.12	17	39	27						
	^ MS11HS3P4067	P	0.67	0.12	17	7	5	6	0.85	12	0.066	0.15	0.33
	^ MS11HS3P4095	P	0.95	0.12	17	3.7	2.7						
	^ MS11HS3P4140	P	1.4	0.12	17	1.8	1.2						
52 mm (2.05 in.)	MS11HS5P4030	P	0.3	0.16	23	40	31						
	^ MS11HS5P4070	P	0.7	0.16	23	6.7	5.6						
	^ MS11HS5P4100	P	1	0.17	24	3.7	3	8	1.1	18	0.098	0.2	0.44
	^ MS11HS5P4150	P	1.5	0.16	23	1.64	1.22						

^ Preferred model

MS11HS - 6 Lead Uni-Polar

Length	Model Number	Connect	Rated Current	Holding Torque		Winding Ohms mH		Detent Torque		Rotor Inertia		Motor Weight	
	Single Shaft	P=Side Plug L=Leads	Amps (mounted)	Nm Typ.	oz-in TYP.	@20 C	Typ.	mNm	oz-in	g cm ²	oz-in ²	kg	Lbs
32 mm (1.26 in.)	MS11HS1P6024	P	0.24	0.06	9	48	18.2						
	MS11HS1P6050	P	0.5	0.07	9	10.9	4.5	5	0.71	9	0.049	0.1	0.22
	MS11HS1P6070	P	0.7	0.07	9	5.5	2.3						
41 mm (1.61 in.)	MS11HS3P6026	P	0.26	0.09	12	49	15.7						
	MS11HS3P6067	P	0.67	0.09	13	7.5	2.6	6	0.85	12	0.066	0.15	0.33
	MS11HS3P6095	P	0.95	0.09	12	3.5	1.2						
52 mm (2.05 in.)	MS11HS5P6033	P	0.33	0.12	17	35	13.6						
	MS11HS5P6067	P	0.67	0.12	17	8.1	3.2	8	1.1	18	0.098	0.2	0.44
	MS11HS5P6095	P	0.95	0.12	17	4.3	1.6						

^ Preferred model

Mating Connector With Leads (order separately)

Dimensions: mm (in)

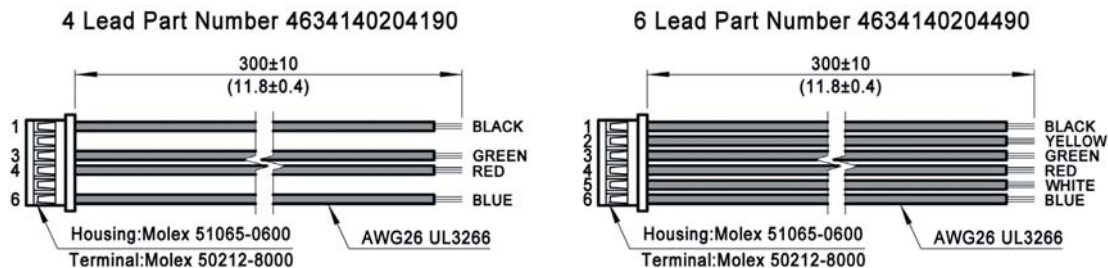

MS11HS1-Bipolar

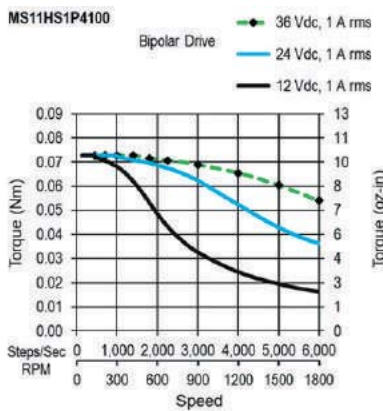
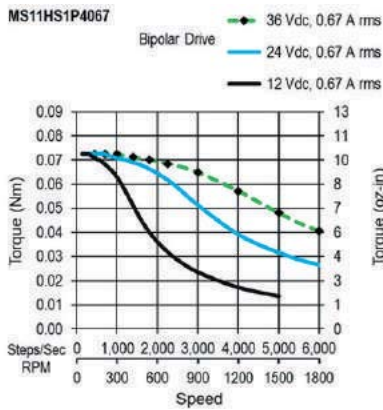
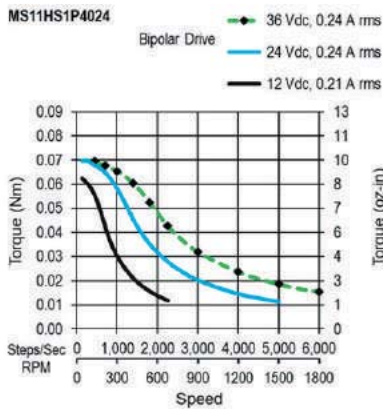

MS11HS3-Bipolar

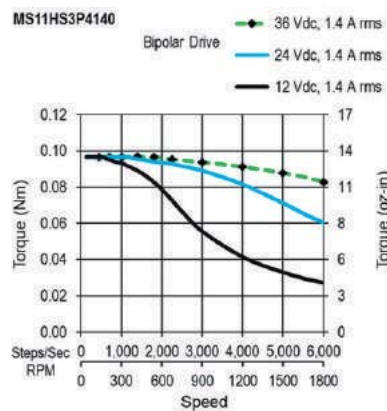
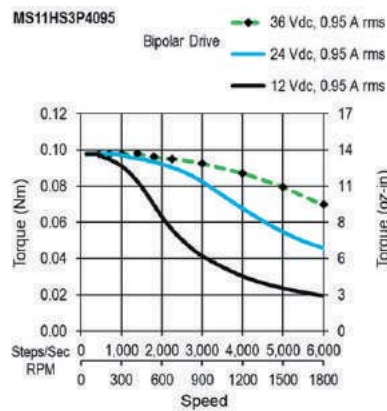
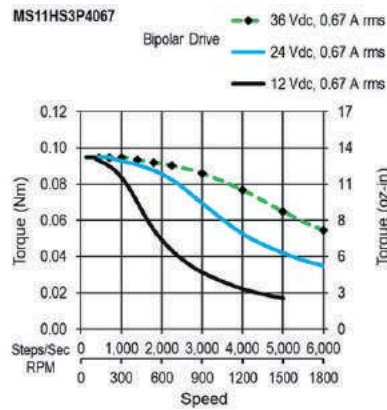
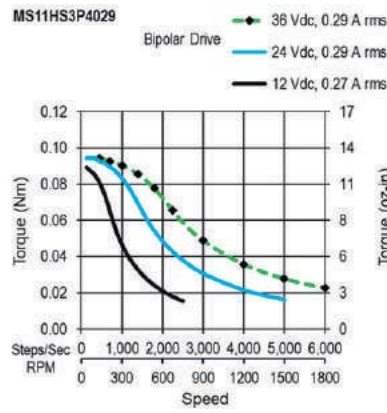

MS11HS5-Bipolar

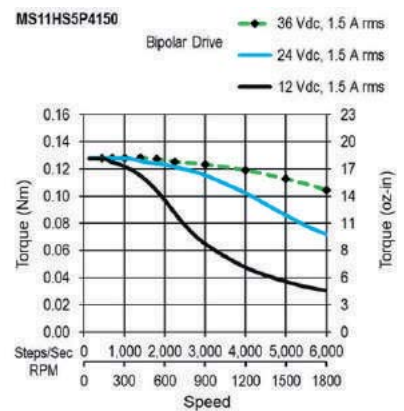
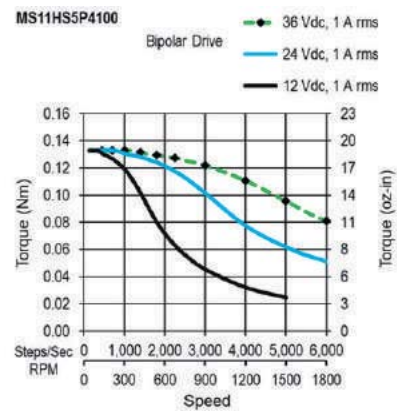
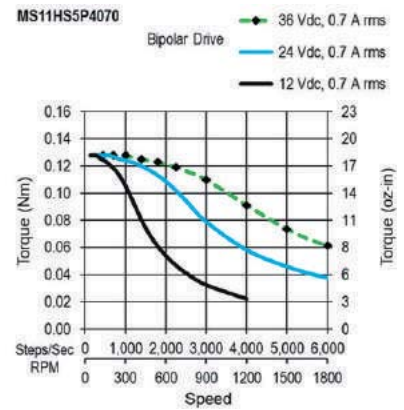
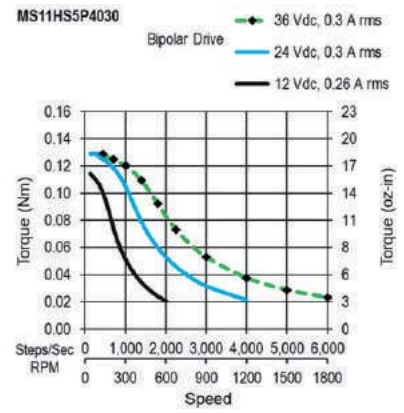

MS11HS1-Unipolar

MS11HS3-Unipolar

MS11HS5-Unipolar

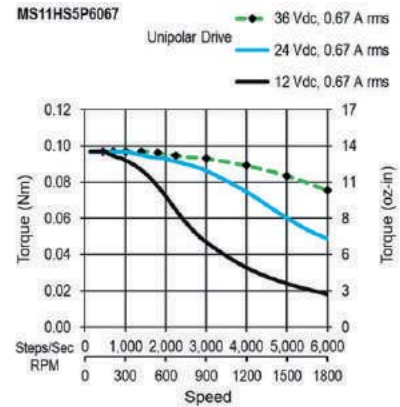
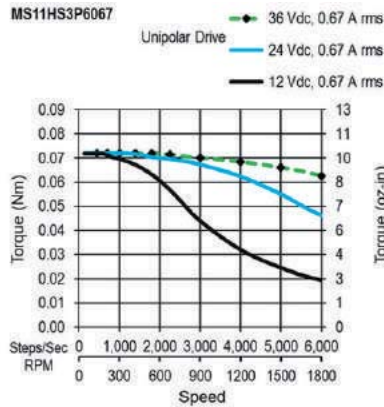
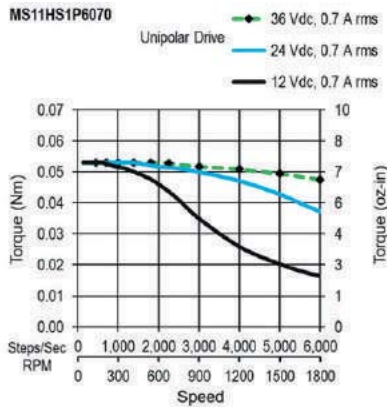
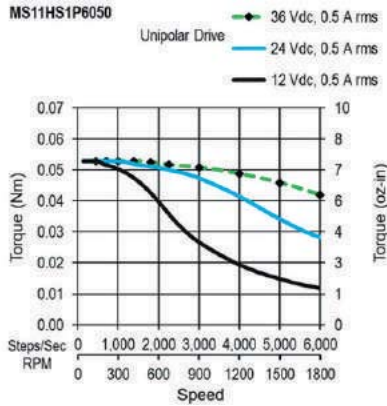
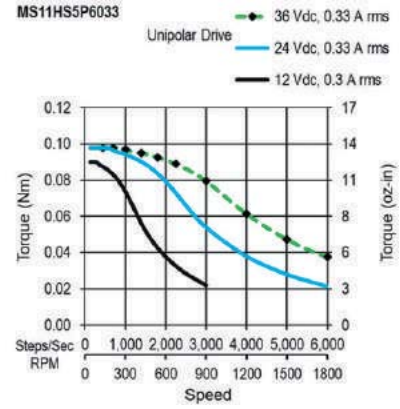
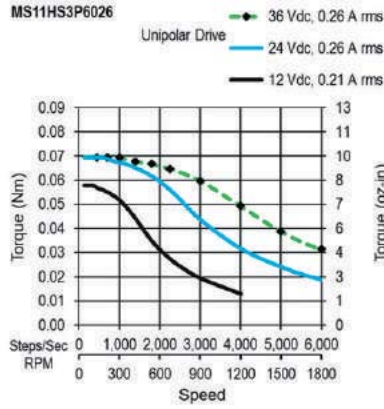
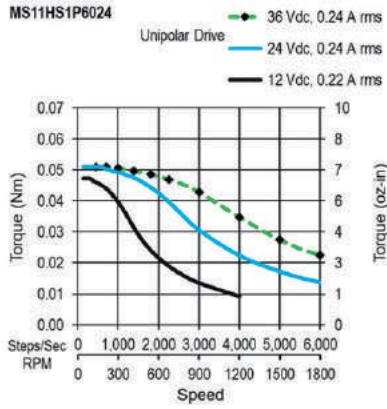

14HK Series: 0.9° - Size 14 Encapsulated



- Phases 2
- Steps / Revolution 400
- Step Accuracy ±5%
- Shaft Load (20,000 Hours at 1000 RPM)
 - Axial 25 N (5.6 Lbs.) Push
65 N (15 Lbs.) Pull
 - Radial 30 N (6.5 Lbs.) At End of Shaft
- IP Rating 40
- Approvals RoHS
- Operating Temp. -20°C to +50°C
- Insulation Class B, 130°C
- Insulation Resistance 100 MegOhms

14HK - 4 Lead Bipolar

Length	Model Number	Connect	Rated Current	Holding Torque		Winding		Detent Torque		Rotor Inertia		Motor Weight	
	Single Shaft	P=Side Plug L=Leads	Amps (mounted)	Nm Typ.	oz-in TYP.	@20 °C	Typ.	mNm	oz-in	g cm ²	oz-in ²	kg	Lbs
12.8 mm (0.5 in.)	14HK0405N	L	0.3	0.044	6	16.3	8.5						
	^ 14HK0406N	L	0.5	0.044	6	6.3	3.1	4	0.57	4	0.022	0.05	0.11
	^ 14HK0407N	L	0.6	0.044	6	4.2	2.1						
	^ 14HK0408N	L	0.8	0.044	6	2.6	1.21						
20.2 mm (0.8 in.)	14HK2404N	L	0.3	0.12	17	26	21						
	^ 14HK2405N	L	0.5	0.12	17	11.7	9.5	10	1.4	11	0.06	0.11	0.24
	^ 14HK2406N	L	0.6	0.12	17	7.1	5.4						
	^ 14HK2407N	L	0.8	0.12	17	4.4	3.2						

^ Preferred model

Dimensions: mm (in)

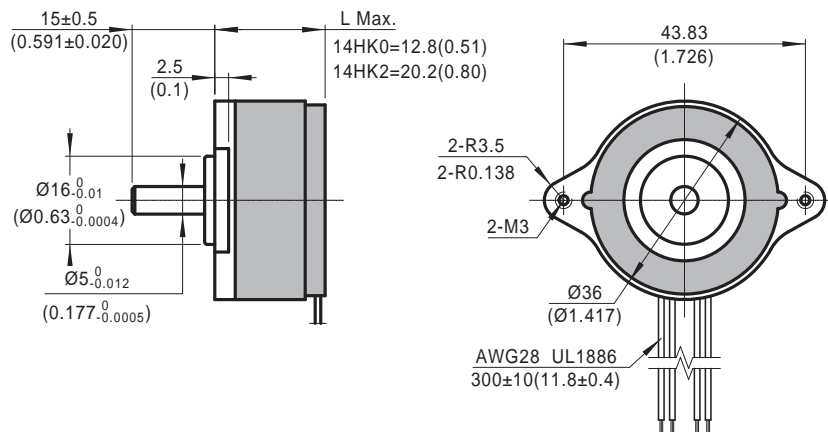
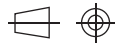

14HK0-0.9° Bipolar

14HK2-0.9° Bipolar

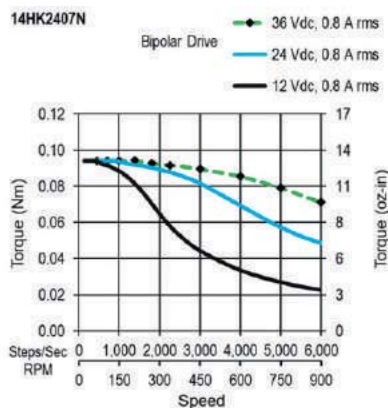
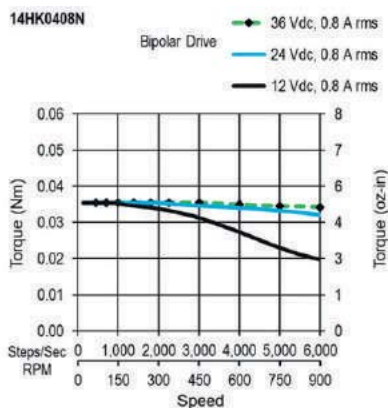
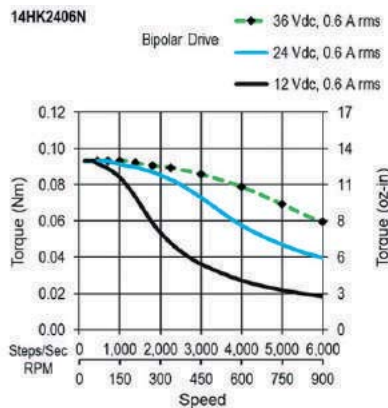
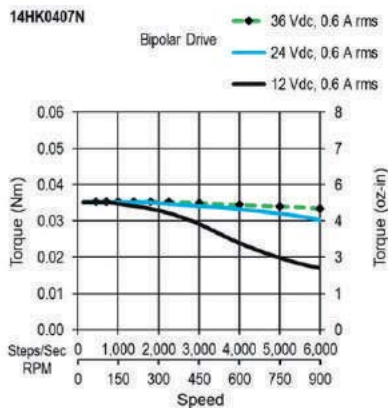
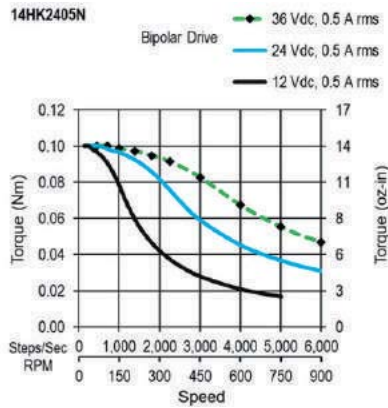
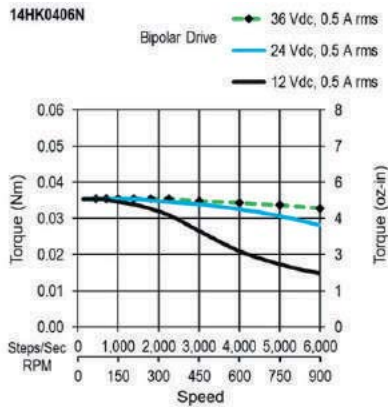
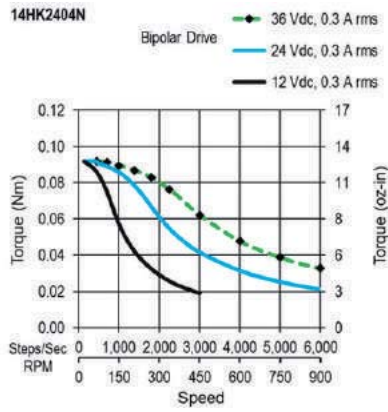
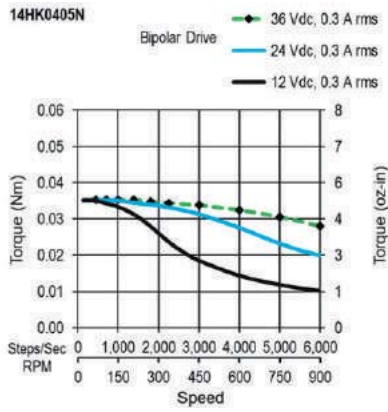

MS14HA - 4 Lead Bi-Polar

Length	Model Number	Connect	Rated Current	Holding Torque		Winding Ohms mH		Detent Torque		Rotor Inertia		Motor Weight	
	Single Shaft	P=Side Plug L=Leads	Amps (mounted)	Nm Typ.	oz-in TYP.	@20 C	Typ.	mNm	oz-in	g cm ²	oz-in ²	kg	Lbs
27.3 mm (1.07 in.)	MS14HA1P4026	P	0.26	0.12	16	45	56						
	^ MS14HA1P4070	P	0.7	0.12	17	6.1	8.2						
	^ MS14HA1P4100	P	1	0.12	17	3.1	3.9	4	0.57	12	0.066	0.15	0.33
	^ MS14HA1P4150	P	1.5	0.12	17	1.43	1.8						
36 mm (1.42 in.)	MS14HA3P4032	P	0.32	0.19	27	37	51						
	^ MS14HA3P4075	P	0.75	0.18	25	6	8.6						
	^ MS14HA3P4100	P	1	0.18	25	3.3	4.9	8	1.1	20	0.11	0.21	0.46
	^ MS14HA3P4150	P	1.5	0.18	25	1.61	2.2						
55.5 mm (2.19 in.)	MS14HA5P4040	P	0.4	0.32	45	30	49						
	^ MS14HA5P4100	P	1	0.32	45	5.1	8.2						
	^ MS14HA5P4150	P	1.5	0.32	45	2.1	3.6	10	1.4	35	0.19	0.24	0.53
	^ MS14HA5P4200	P	2	0.32	45	1.34	2.1						

^ Preferred model

MS14HA - 6 Lead Uni-Polar

Length	Model Number	Connect	Rated Current	Holding Torque		Winding Ohms mH		Detent Torque		Rotor Inertia		Motor Weight	
	Single Shaft	P=Side Plug L=Leads	Amps (mounted)	Nm Typ.	oz-in TYP.	@20 C	Typ.	mNm	oz-in	g cm ²	oz-in ²	kg	Lbs
27.3 mm (1.07 in.)	MS14HA1P6026	P	0.26	0.09	13	44	27						
	MS14HA1P6060	P	0.6	0.09	13	8.2	5.3	4	0.57	12	0.066	0.15	0.33
	MS14HA1P6100	P	1	0.09	13	3.1	2						
36 mm (1.42 in.)	MS14HA3P6032	P	0.32	0.13	18	37	21						
	MS14HA3P6070	P	0.7	0.14	20	7.5	5.3	8	1.1	20	0.11	0.21	0.46
	MS14HA3P6110	P	1.1	0.14	20	3	2						
55.5 mm (2.19 in.)	MS14HA5P6040	P	0.4	0.25	35	31	26						
	MS14HA5P6085	P	0.85	0.26	37	7.1	6.1	10	1.4	35	0.19	0.24	0.53
	MS14HA5P6120	P	1.2	0.25	35	3.5	2.9						

^ Preferred model

Mating Connector With Leads (order separately)

Dimensions: mm (in)

4 Lead Part Number 4634 1402 04581

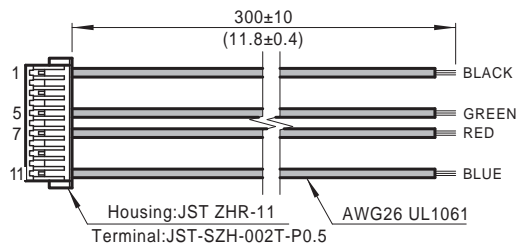

6 Lead Part Number 4634 1402 04489

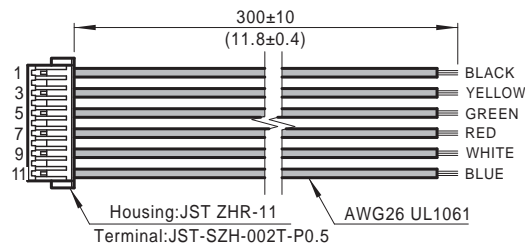

MS14HA1-0.9° Bipolar

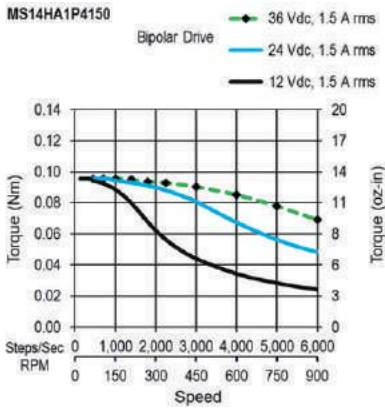
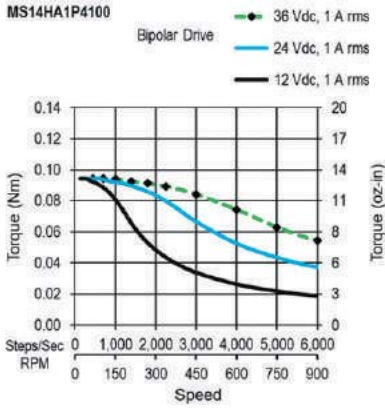
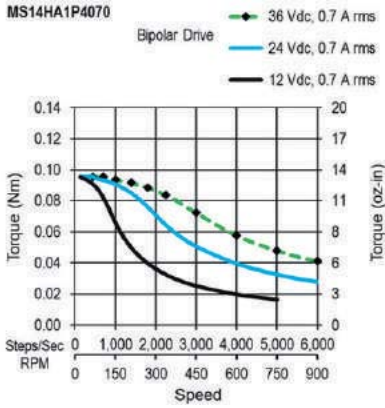
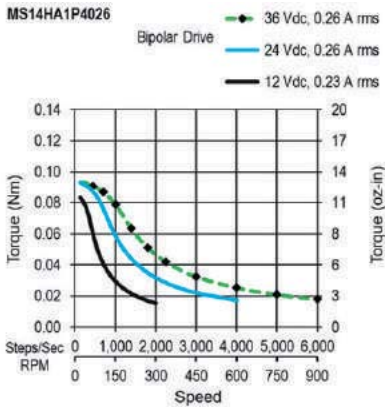

MS14HA3-0.9° Bipolar

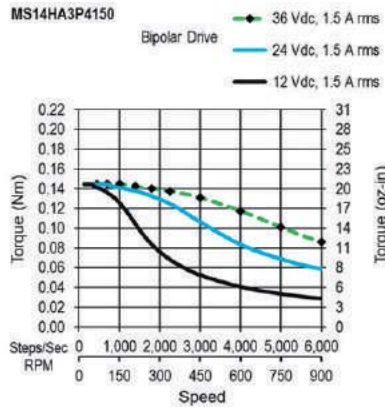
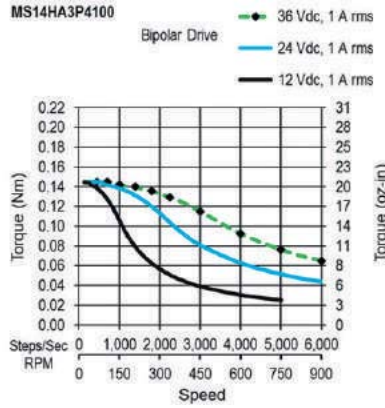
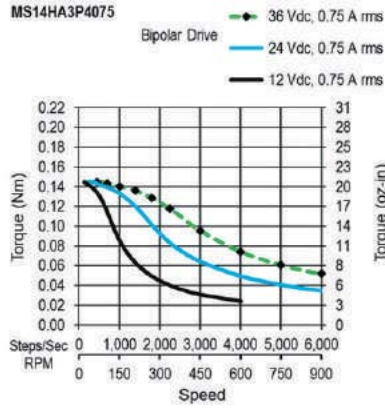
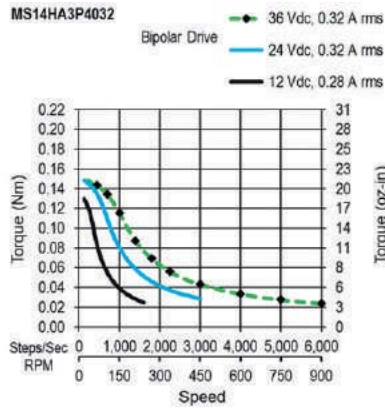

MS14HA5-0.9° Bipolar

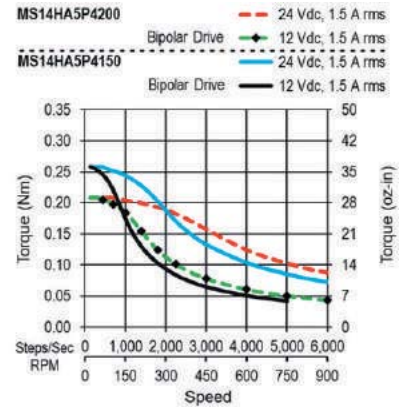
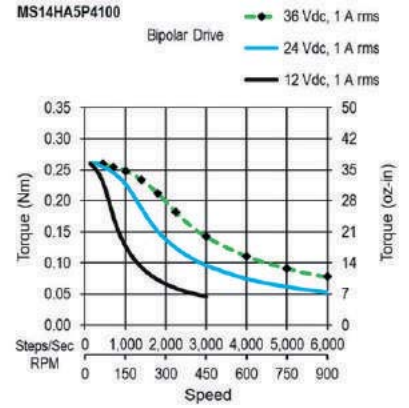
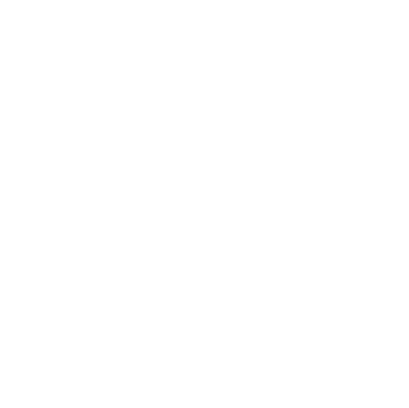
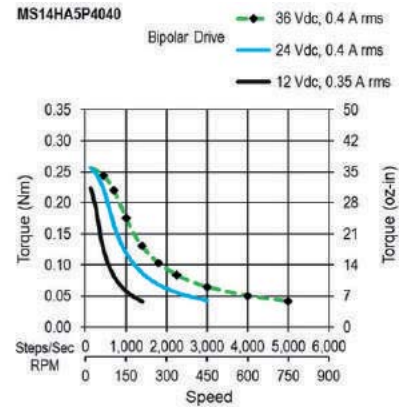

MS14HA1-0.9° Unipolar

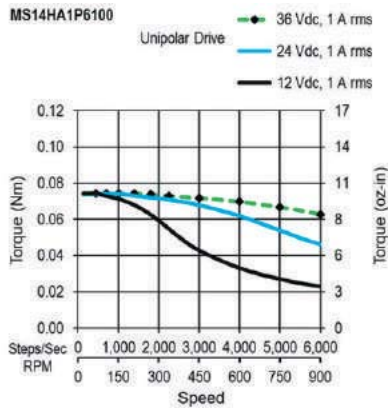
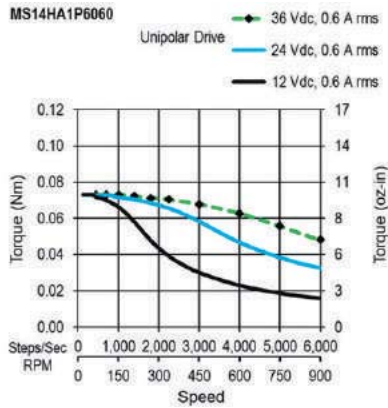
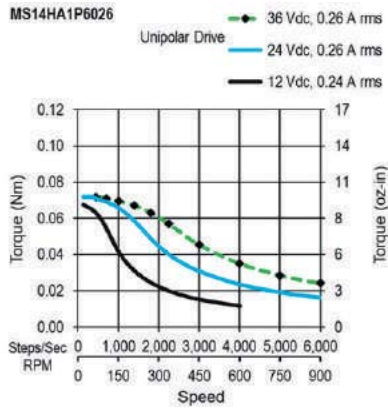

MS14HA3-0.9° Unipolar

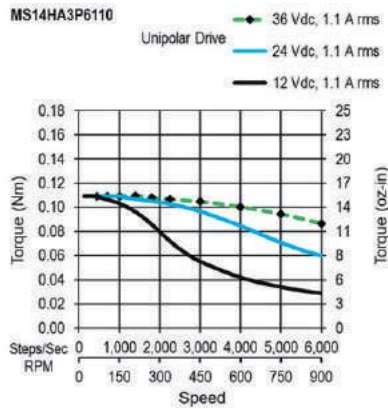
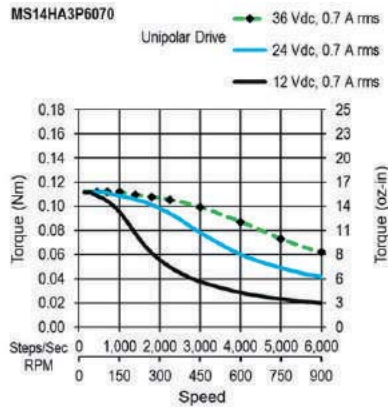
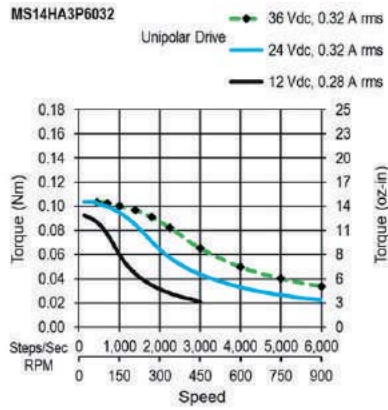

MS14HA5-0.9° Unipolar

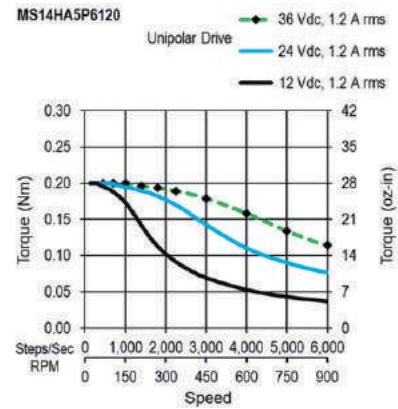
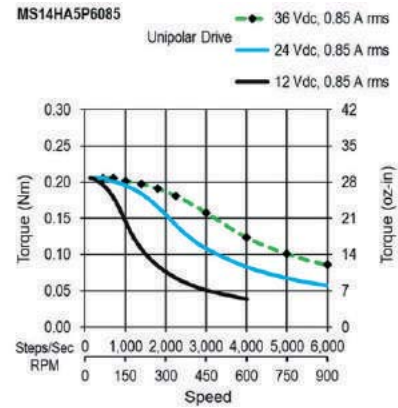
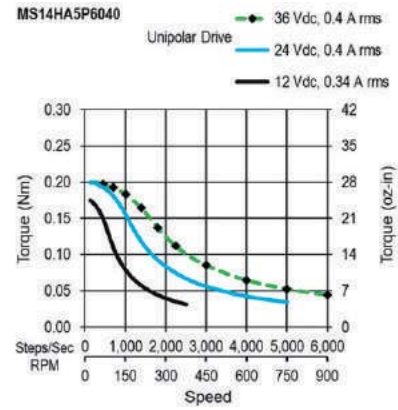

MS14HS - 4 Lead Bi-Polar

Length	Model Number	Connect	Rated Current	Holding Torque		Winding Ohms mH		Detent Torque		Rotor Inertia		Motor Weight	
	Single Shaft	P=Side Plug L=Leads	Amps (mounted)	Nm Typ.	oz-in TYP.	@20 C	Typ.	mNm	oz-in	g cm ²	oz-in ²	kg	Lbs
27.3 mm (1.07 in.)	MS14HS1P4026	P	0.26	0.14	20	49	50						
	^ MS14HS1P4070	P	0.7	0.14	20	6.6	7.4						
	^ MS14HS1P4100	P	1	0.14	20	3.3	3.5	10	1.4	12	0.066	0.15	0.33
	^ MS14HS1P4150	P	1.5	0.14	20	1.55	1.62						
36 mm (1.42 in.)	MS14HS3P4032	P	0.32	0.24	34	37	52						
	^ MS14HS3P4075	P	0.75	0.23	33	6	8.9	15	2.1	20	0.11	0.21	0.46
	^ MS14HS3P4100	P	1	0.23	33	3.4	5						
	^ MS14HS3P4150	P	1.5	0.23	33	1.62	2.2						
55.5 mm (2.19 in.)	MS14HS5P4040	P	0.4	0.39	55	30	50						
	^ MS14HS5P4100	P	1	0.40	57	5.1	8.3	18	2.5	35	0.19	0.24	0.53
	^ MS14HS5P4150	P	1.5	0.40	57	2.2	3.6						
	^ MS14HS5P4200	P	2	0.40	57	1.34	2.1						

^ Preferred model

MS14HS - 6 Lead Uni-Polar

Length	Model Number	Connect	Rated Current	Holding Torque		Winding Ohms mH		Detent Torque		Rotor Inertia		Motor Weight	
	Single Shaft	P=Side Plug L=Leads	Amps (mounted)	Nm Typ.	oz-in TYP.	@20 C	Typ.	mNm	oz-in	g cm ²	oz-in ²	kg	Lbs
27.3 mm (1.07 in.)	MS14HS1P6022	P	0.22	0.11	15	68	34						
	MS14HS1P6060	P	0.6	0.11	15	8.9	4.8	10	1.4	12	0.066	0.15	0.33
	MS14HS1P6100	P	1	0.11	16	3.3	1.81						
36 mm (1.42 in.)	MS14HS3P6032	P	0.32	0.17	24	37	22						
	MS14HS3P6070	P	0.7	0.18	25	7.5	5.4	15	2.1	20	0.11	0.21	0.46
	MS14HS3P6110	P	1.1	0.18	25	3	2.1						
55.5 mm (2.19 in.)	MS14HS5P6040	P	0.4	0.30	42	31	26						
	MS14HS5P6085	P	0.85	0.31	44	7.1	6.2	18	2.5	35	0.19	0.24	0.53
	MS14HS5P6120	P	1.2	0.30	42	3.5	2.9						

^ Preferred model

Mating Connector With Leads (order separately)

Dimensions: mm (in)

4 Lead Part Number 4634 1402 04581

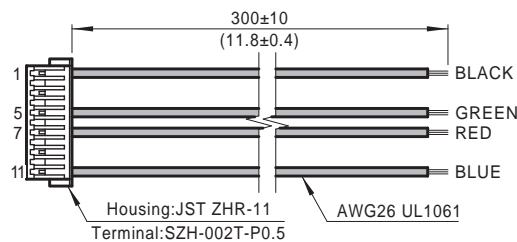

6 Lead Part Number 4634 1402 04489

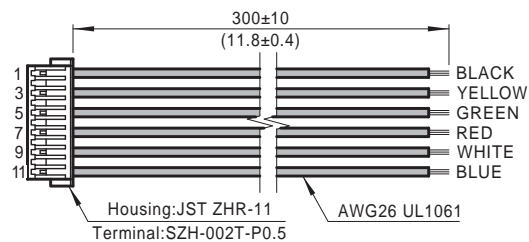

MS14HS1 - Bipolar

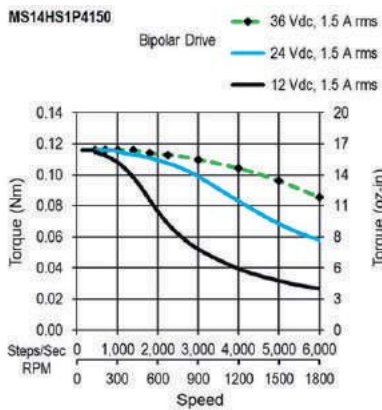
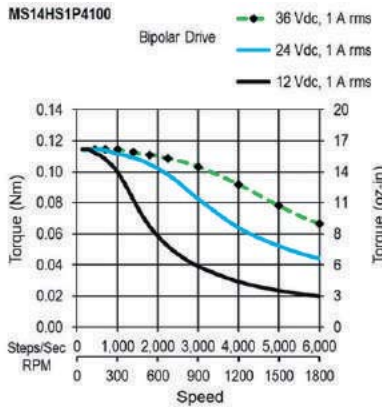
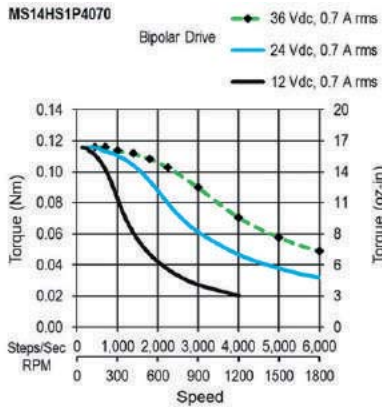
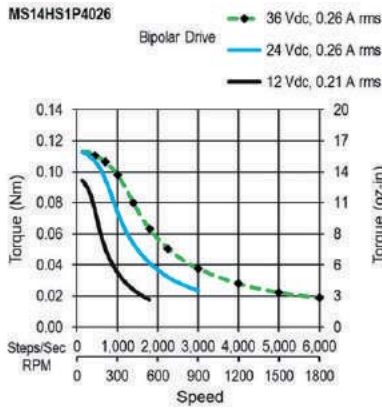

MS14HS3 - Bipolar

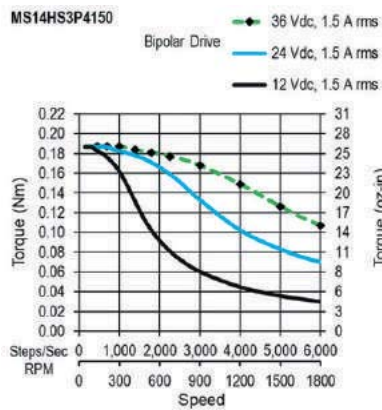
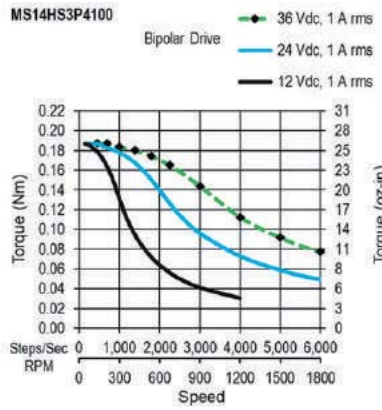
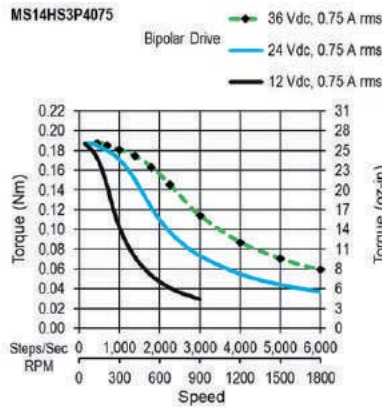
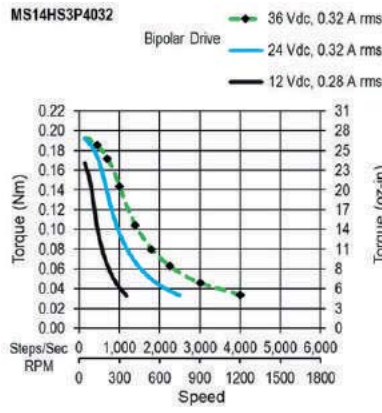

MS14HS5 - Bipolar

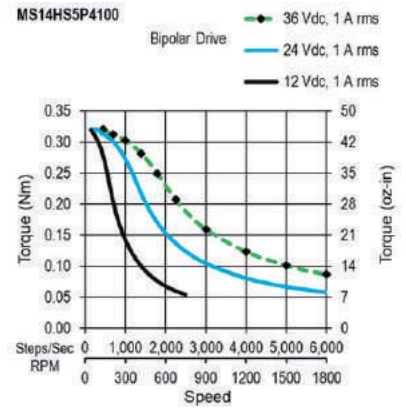
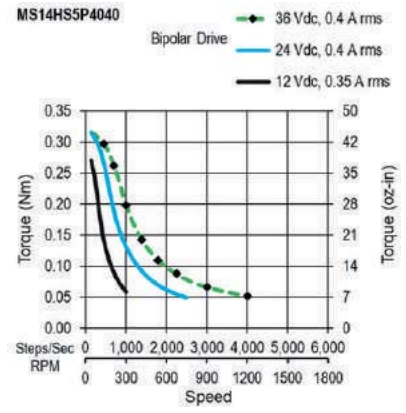

MS14HS1 - Unipolar

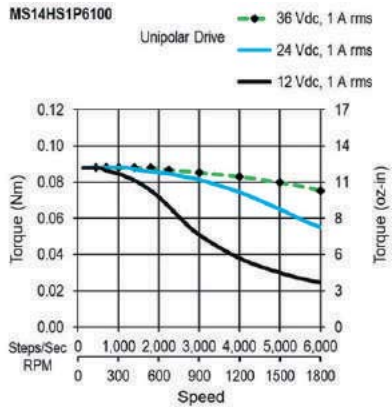
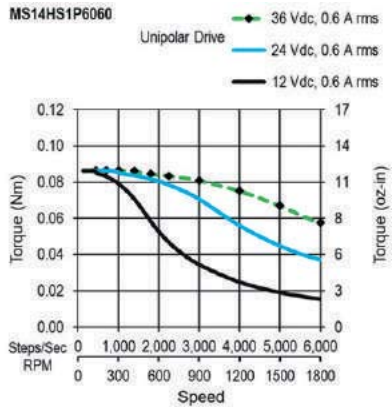
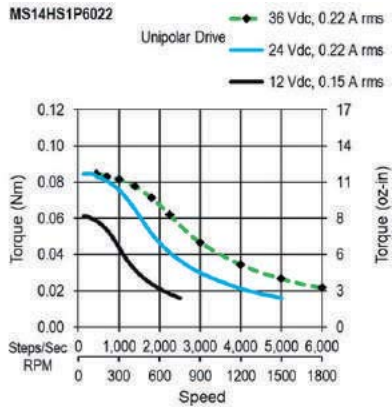

MS14HS3 - Unipolar

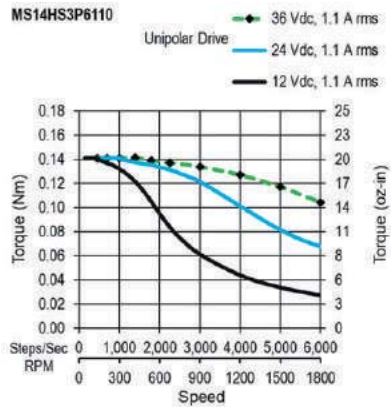
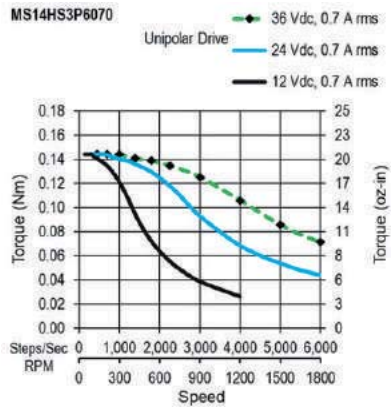
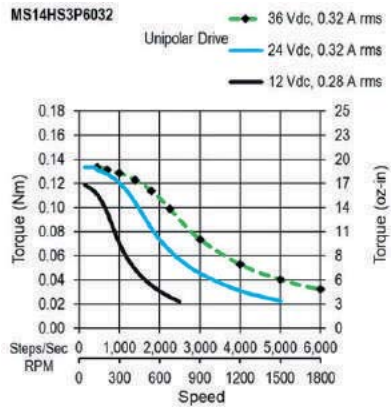

MS14HS5 - Unipolar

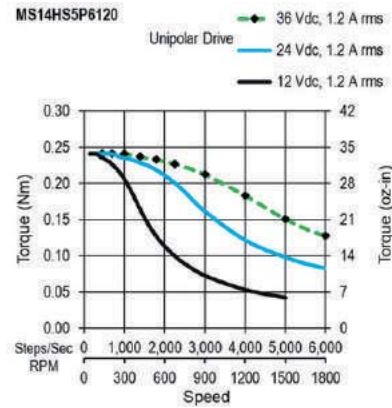
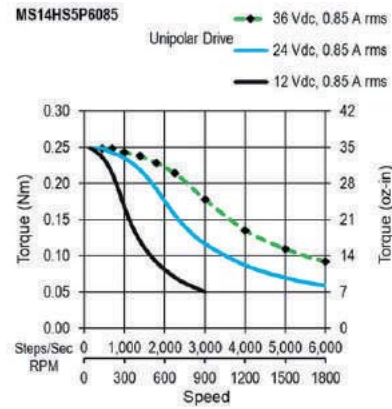
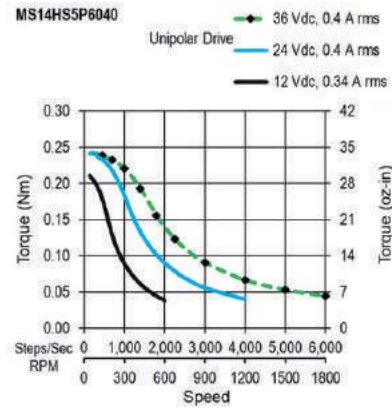

MS16HR7- Bipolar

MS16HR0- Bipolar

MS16HR4- Bipolar

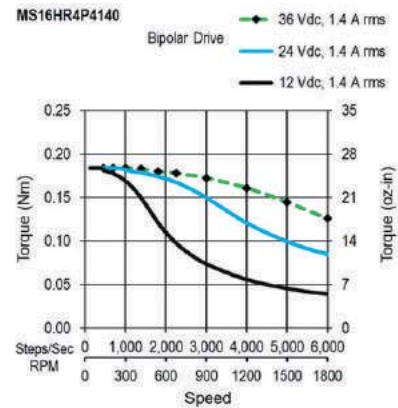
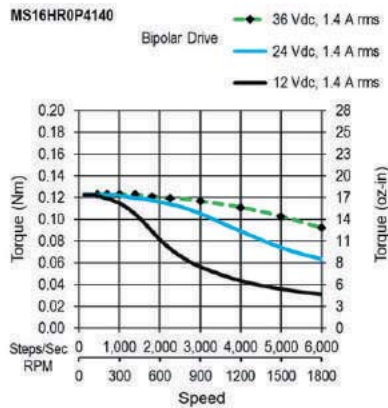
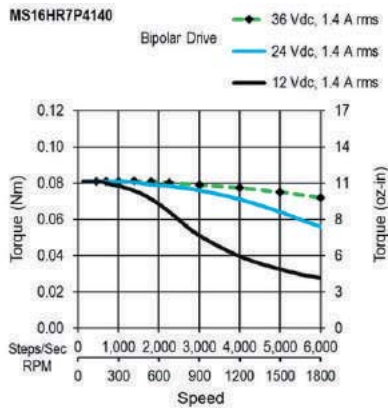
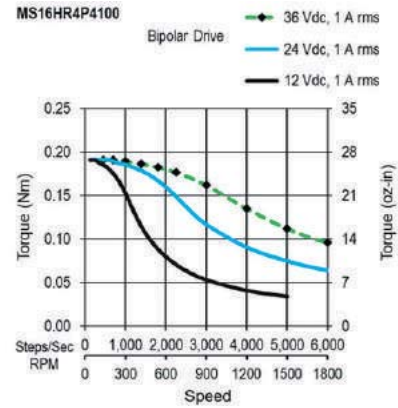
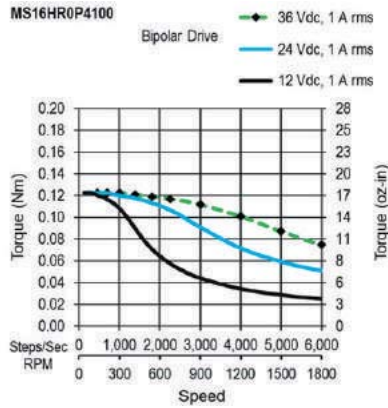
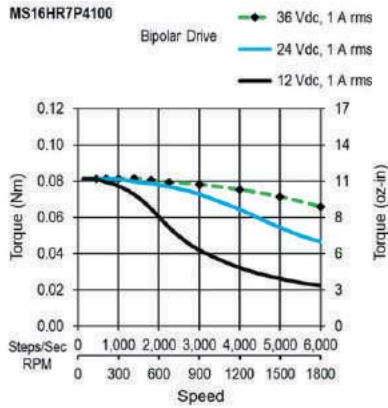
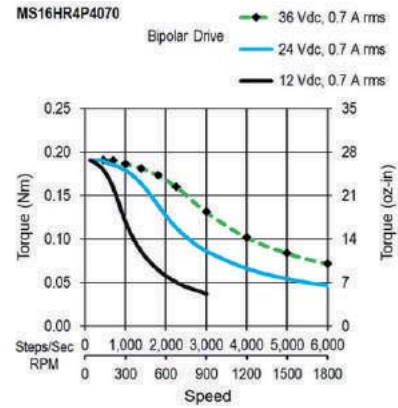
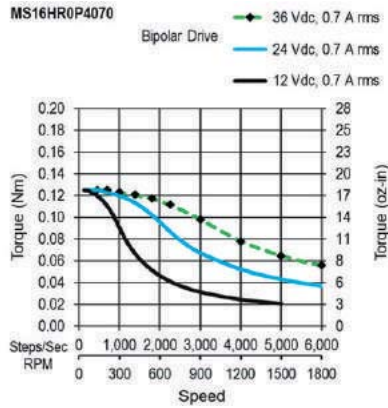
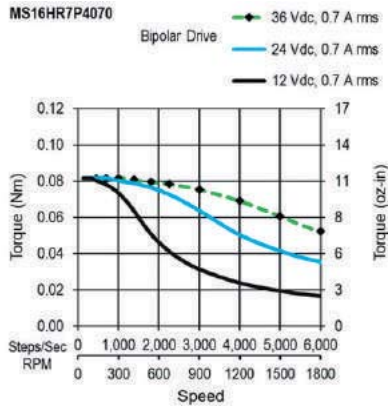
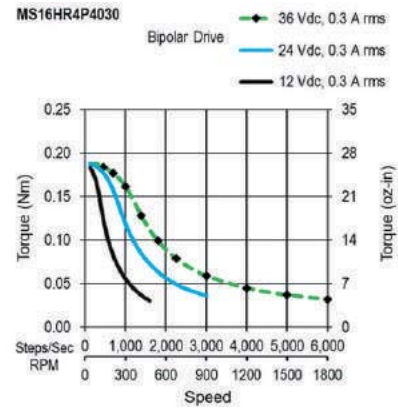
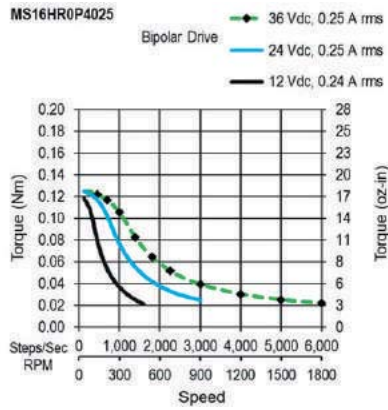
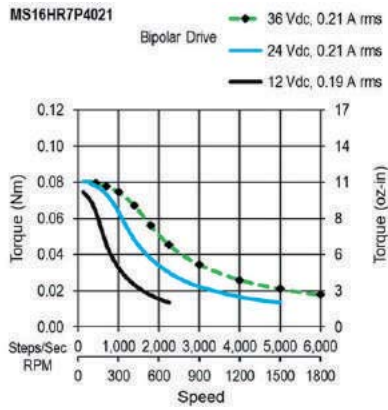

MS16HS - 4 Lead Bi-Polar

Length	Model Number	Connect	Rated Current	Holding Torque		Winding Ohms mH		Detent Torque		Rotor Inertia		Motor Weight	
	Single Shaft	P=Side Plug L=Leads	Amps (mounted)	Nm Typ.	oz-in TYP.	@20 C	Typ.	mNm	oz-in	g cm ²	oz-in ²	kg	Lbs
20.8 mm (0.82 in.)	MS16HS7P4027	P	0.27	0.10	14	41	36						
	^ MS16HS7P4070	P	0.7	0.10	14	5.6	5.6						
	^ MS16HS7P4100	P	1	0.10	14	3	2.8	5	0.71	14	0.077	0.11	0.24
	^ MS16HS7P4150	P	1.5	0.10	14	1.45	1.28						
26 mm (1.02 in.)	MS16HS0P4029	P	0.29	0.20	28	40	52						
	^ MS16HS0P4070	P	0.7	0.20	28	6.8	9.5	8	1.1	20	0.11	0.15	0.33
	^ MS16HS0P4100	P	1	0.20	28	3.6	4.7						
	^ MS16HS0P4150	P	1.5	0.20	28	1.53	2						
33 mm (1.3 in.)	MS16HS4P4037	P	0.37	0.26	37	31	50						
	^ MS16HS4P4070	P	0.7	0.26	37	8.4	14	12	1.7	27	0.15	0.21	0.46
	^ MS16HS4P4100	P	1	0.27	38	4.4	7						
	^ MS16HS4P4150	P	1.5	0.27	38	1.89	3.1						

^ Preferred model

MS16HS - 6 Lead Uni-Polar

Length	Model Number	Connect	Rated Current	Holding Torque		Winding Ohms mH		Detent Torque		Rotor Inertia		Motor Weight	
	Single Shaft	P=Side Plug L=Leads	Amps (mounted)	Nm Typ.	oz-in TYP.	@20 C	Typ.	mNm	oz-in	g cm ²	oz-in ²	kg	Lbs
20.8 mm (0.82 in.)	MS16HS7P6024	P	0.24	0.07	10	50	21						
	MS16HS7P6070	P	0.7	0.07	10	5.5	2.6	5	0.71	14	0.077	0.11	0.24
	MS16HS7P6100	P	1	0.07	10	2.7	1.23						
26 mm (1.02 in.)	MS16HS0P6027	P	0.27	0.15	21	45	27						
	MS16HS0P6070	P	0.7	0.16	23	7	4.7	8	1.1	20	0.11	0.15	0.33
	MS16HS0P6100	P	1	0.15	21	3.4	2.2						
33 mm (1.3 in.)	MS16HS4P6036	P	0.36	0.20	28	33	26						
	MS16HS4P6085	P	0.85	0.20	28	5.8	4.7	12	1.7	27	0.15	0.21	0.46
	MS16HS4P6120	P	1.2	0.20	28	3	2.3						

^ Preferred model

Mating Connector With Leads (order separately)

Dimensions: mm (in)

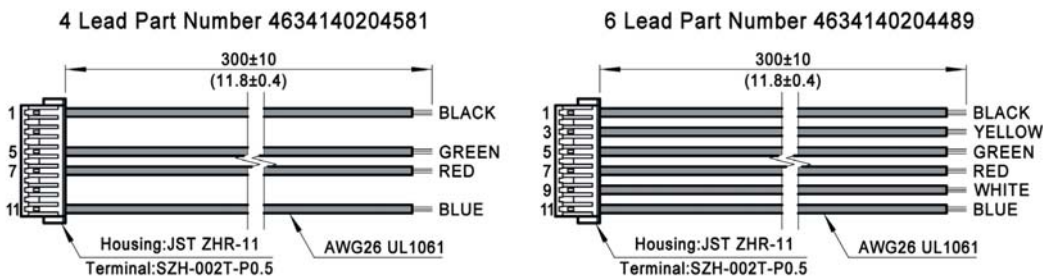

MS16HS7- Bipolar

MS16HS0- Bipolar

MS16HS4- Bipolar

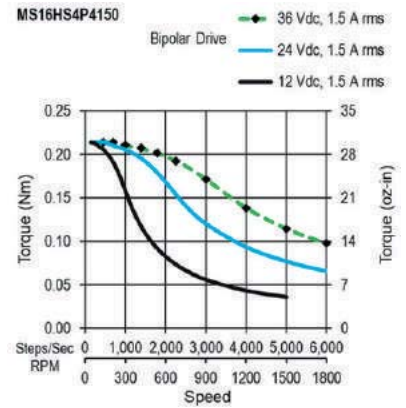
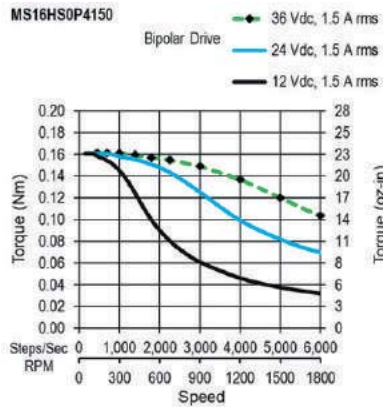
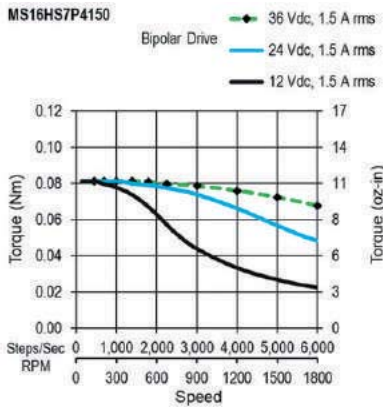
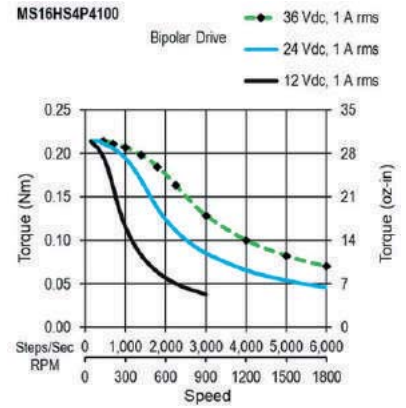
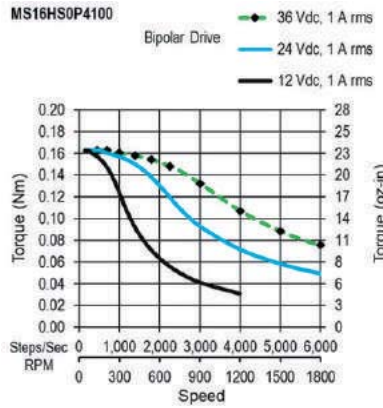
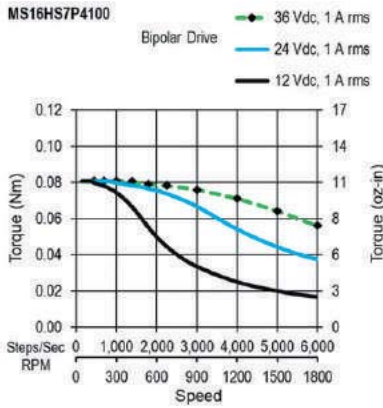
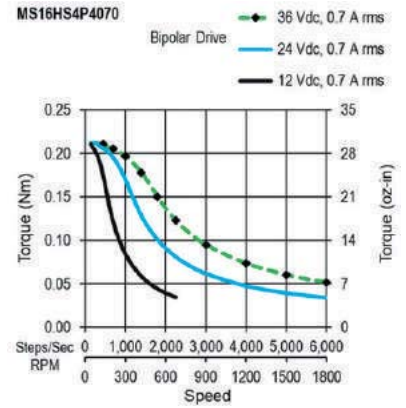
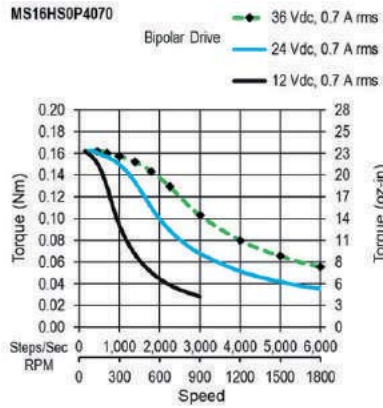
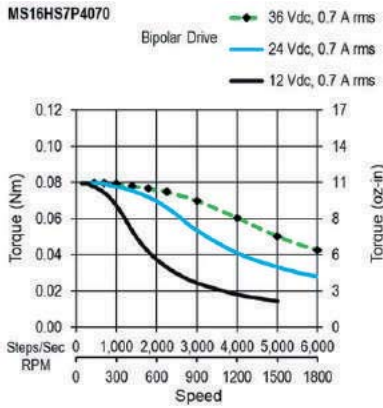
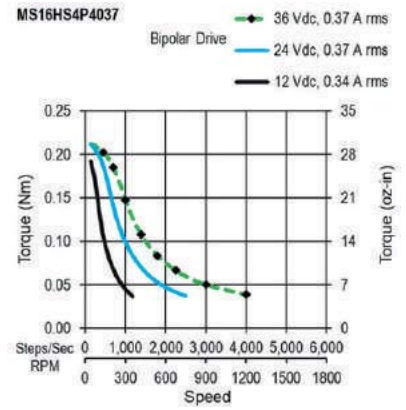
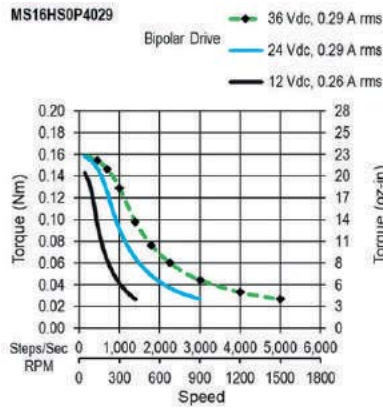
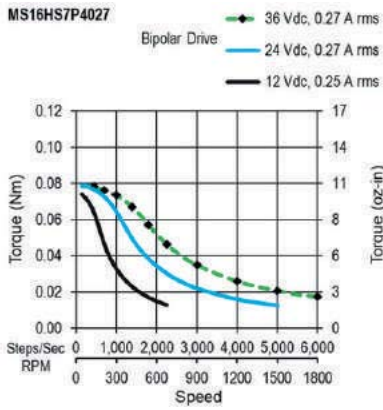

MS16HS7- Unipolar

MS16HS0- Unipolar

MS16HS4- Unipolar

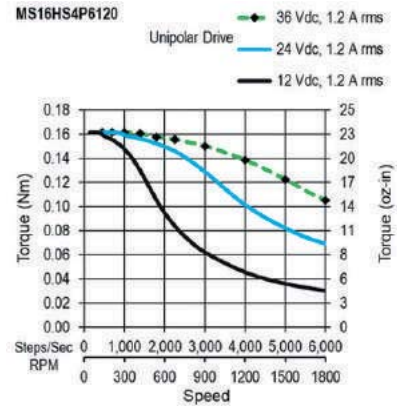
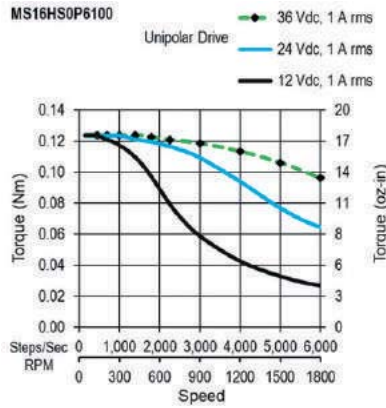
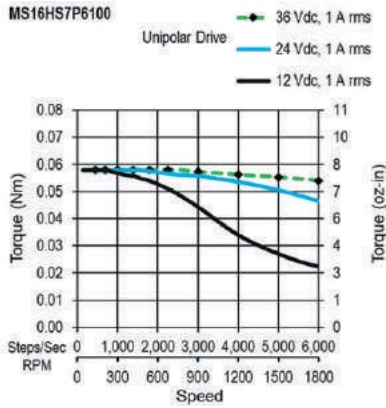
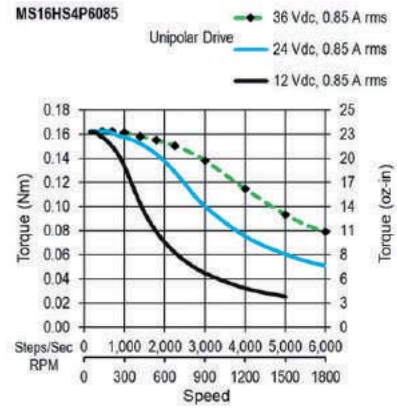
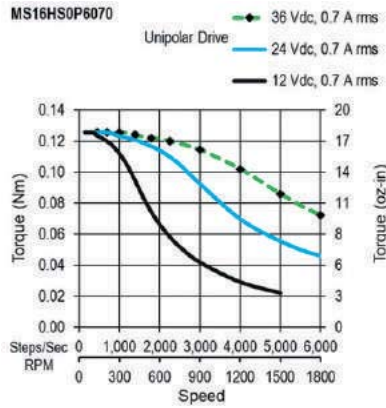
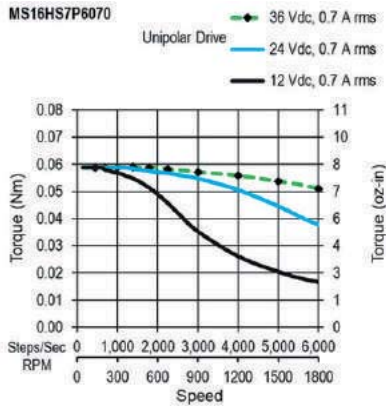
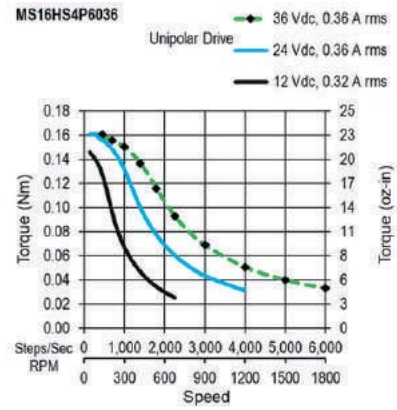
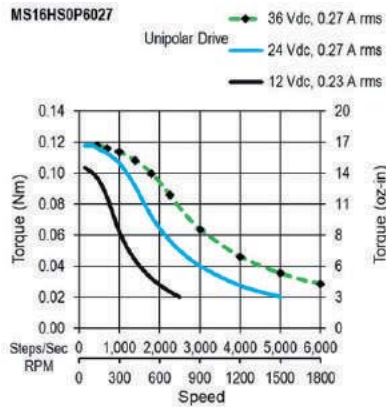
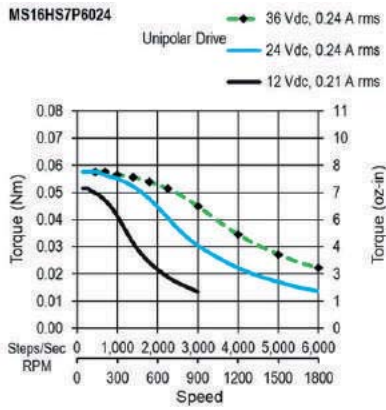

MS17HA Series: 0.9° - Size 17



- Phases 2
- Steps / Revolution 400
- Step Accuracy ±5%
- Shaft Load (20,000 Hours at 1000 RPM)
 - Axial 25 N (5.6 Lbs.) Push
65 N (15 Lbs.) Pull
 - Radial 30 N (6.5 Lbs.) At Flat Center
- IP Rating 40
- Approvals UL Recognized File E465363, RoHS
- Operating Temp. -20°C to +50°C
- Insulation Class B, 130°C
- Insulation Resistance 100 MegOhms

MS17HA 4 P 4 040 -M

Basic Motor Length (Max)

4	34.3mm (1.35 in.)	Short
2	39.8mm (1.57 in.)	1 Stack
6	48.3mm (1.90 in.)	2 Stack

Electrical Connection

P Plug-in Connector

Number of Connections

4	4 Lead-Bipolar
6	6 Lead-Unipolar(or Bipolar)

Options

Omit	No Options
-M	5 mm Diameter Rear Shaft With Encoder Mounting Holes

Winding

Current rating x 100

Dimensions: mm (in)

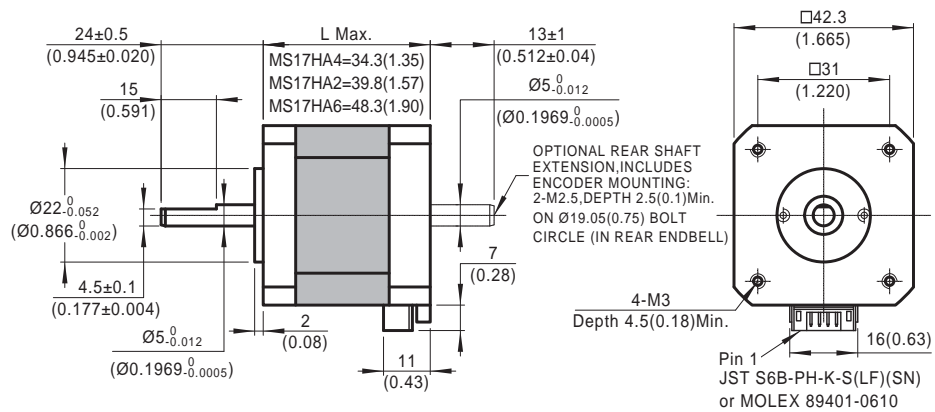
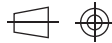

MS17HA - 4 Lead Bi-Polar

Length	Model Number	Connect	Rated Current	Holding Torque		Winding Ohms mH		Detent Torque		Rotor Inertia		Motor Weight	
	Single Shaft	P=Side Plug L=Leads	Amps (mounted)	Nm Typ.	oz-in TYP.	@20 C	Typ.	mNm	oz-in	g cm ²	oz-in ²	kg	Lbs
34.3 mm (1.35 in.)	MS17HA4P4040	P	0.4	0.31	44	28	76						
	^ MS17HA4P4100	P	1	0.30	42	4	11.4						
	^ MS17HA4P4150	P	1.5	0.29	41	1.63	4.4	12	1.7	38	0.21	0.21	0.46
	^ MS17HA4P4200	P	2	0.30	42	1.06	2.7						
39.8 mm (1.57 in.) 1 Stack	MS17HA2P4040	P	0.4	0.41	58	24	73						
	^ MS17HA2P4100	P	1	0.41	58	3.9	11.7						
	^ MS17HA2P4150	P	1.5	0.42	59	1.98	5.7	16	2.3	57	0.31	0.28	0.62
	^ MS17HA2P4200	P	2	0.41	58	1.05	2.9						
48.3 mm (1.9 in.) 2 Stack	MS17HA6P4050	P	0.5	0.58	82	24	81						
	^ MS17HA6P4100	P	1	0.56	79	4.9	17.6						
	^ MS17HA6P4150	P	1.5	0.55	78	2.2	7.5	25	3.5	82	0.45	0.35	0.77
	^ MS17HA6P4200	P	2	0.56	79	1.31	4.4						

^ Preferred model

MS17HA - 6 Lead Uni-Polar

Length	Model Number	Connect	Rated Current	Holding Torque		Winding Ohms mH		Detent Torque		Rotor Inertia		Motor Weight	
	Single Shaft	P=Side Plug L=Leads	Amps (mounted)	Nm Typ.	oz-in TYP.	@20 C	Typ.	mNm	oz-in	g cm ²	oz-in ²	kg	Lbs
34.3 mm (1.35 in.)	MS17HA4P6038	P	0.38	0.25	35	30	41						
	MS17HA4P6085	P	0.85	0.23	33	4.9	6.7	12	1.7	38	0.21	0.21	0.46
	MS17HA4P6120	P	1.2	0.24	34	2.7	3.8						
39.8 mm (1.57 in.) 1 Stack	MS17HA2P6040	P	0.4	0.34	48	28	41						
	MS17HA2P6085	P	0.85	0.34	48	6	8.7	16	2.3	57	0.31	0.28	0.62
	MS17HA2P6130	P	1.3	0.33	47	2.5	3.7						
48.3 mm (1.9 in.) 2 Stack	MS17HA6P6040	P	0.4	0.43	61	29	50						
	MS17HA6P6080	P	0.8	0.44	62	7.6	13.1						
	MS17HA6P6130	P	1.3	0.45	64	3.2	5.5	25	3.5	82	0.45	0.35	0.77
	MS17HA6P6200	P	2	0.44	62	1.3	2.1						

^ Preferred model

Mating Connector With Leads (order separately)

Dimensions: mm (in)

4 Lead Part Number 4634 1402 00723

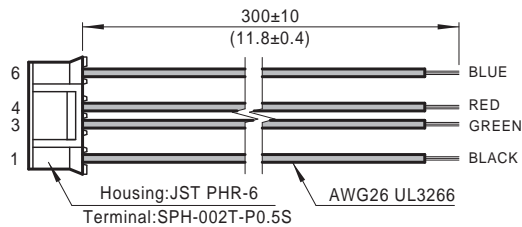

6 Lead Part Number 4634 1402 00922

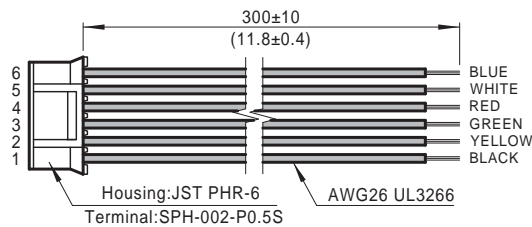

MS17HA4-0.9° Bipolar

MS17HA2-0.9° Bipolar

MS17HA6-0.9° Bipolar

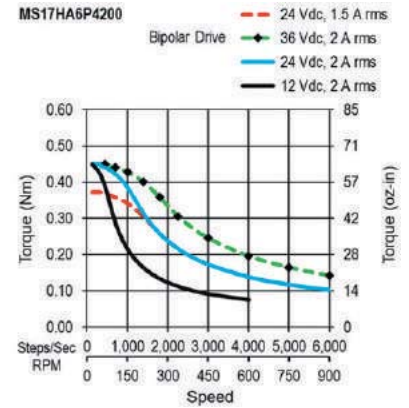
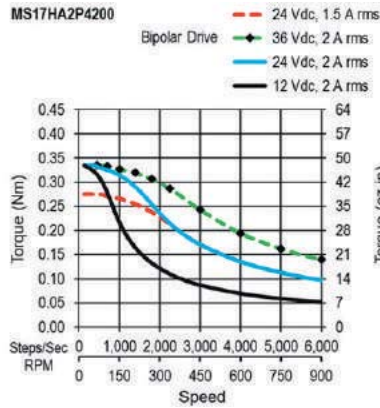
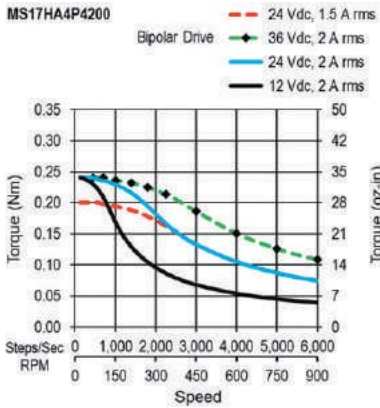
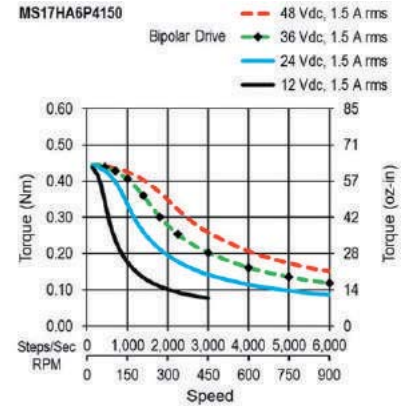
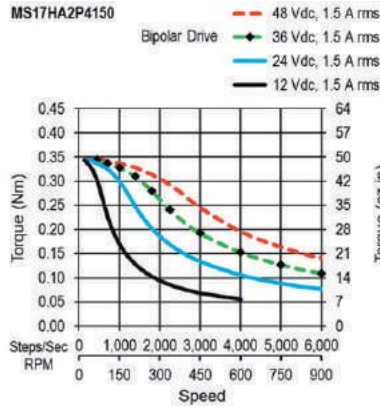
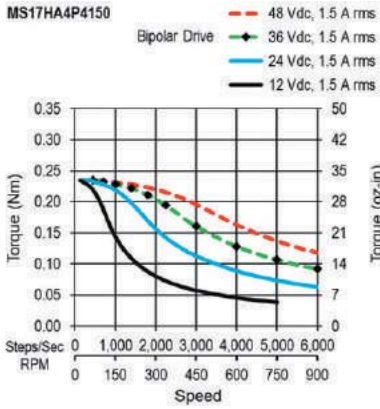
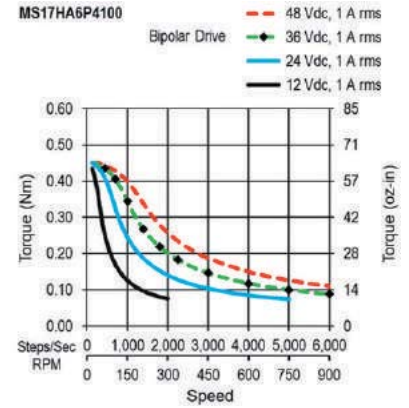
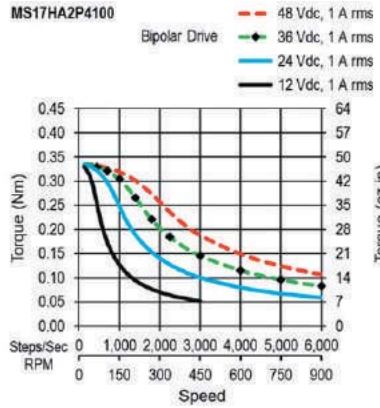
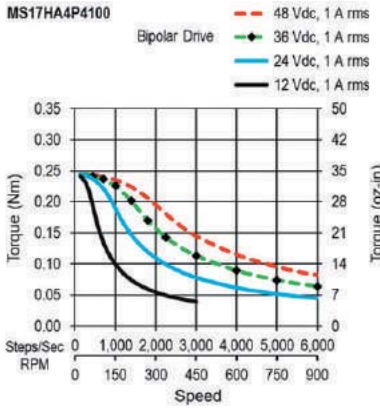
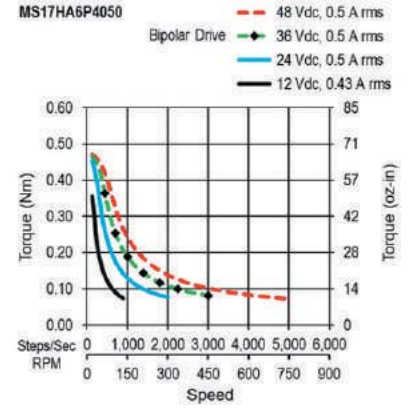
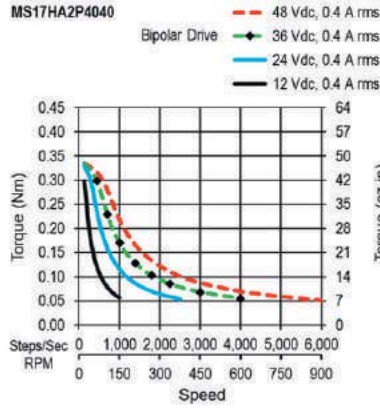
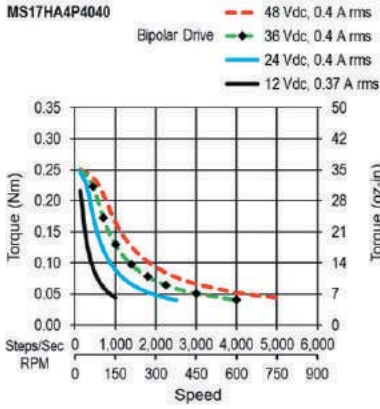

MOONS' Technology

2 Phase Step Motors

3 Phase Step Motors

Technical

MS17HA4-0.9° Unipolar

MS17HA2-0.9° Unipolar

MS17HA6-0.9° Unipolar

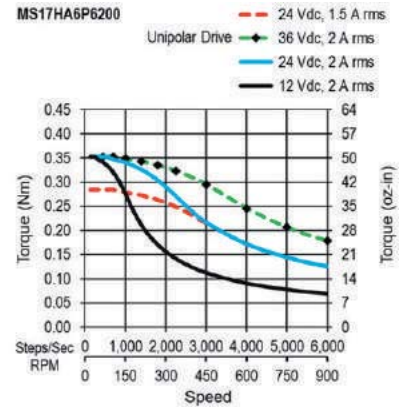
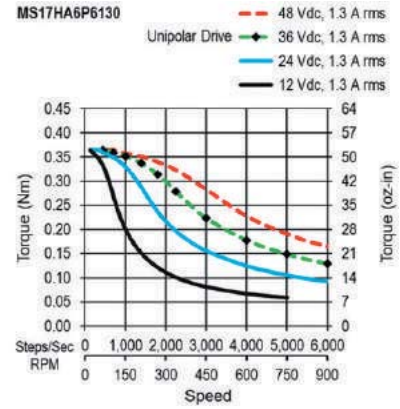
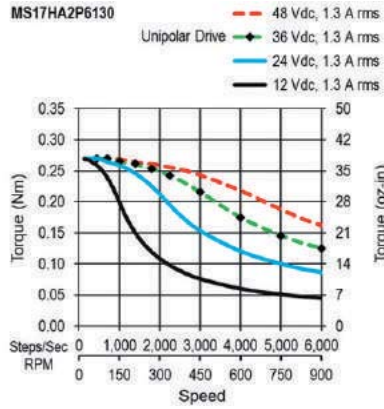
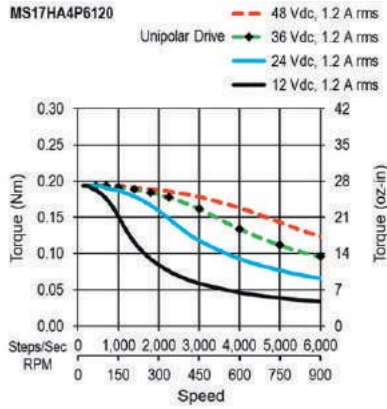
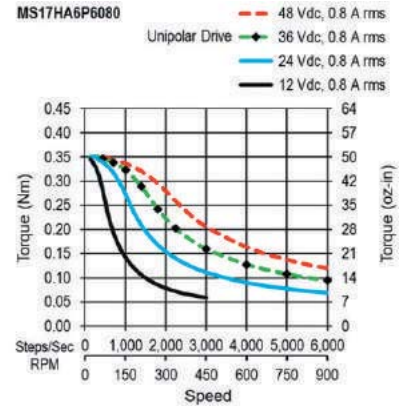
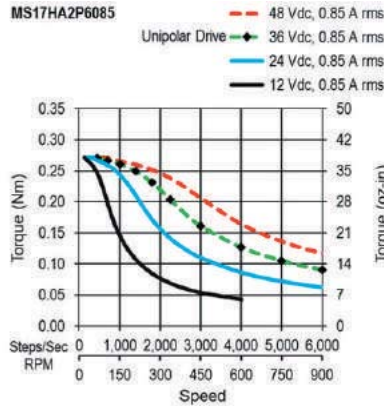
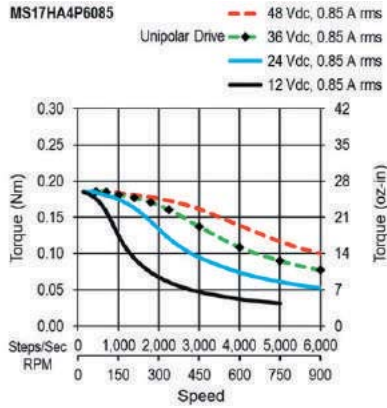
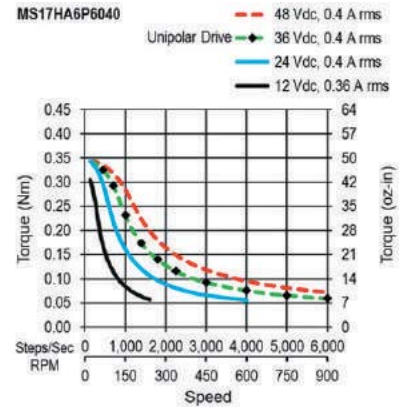
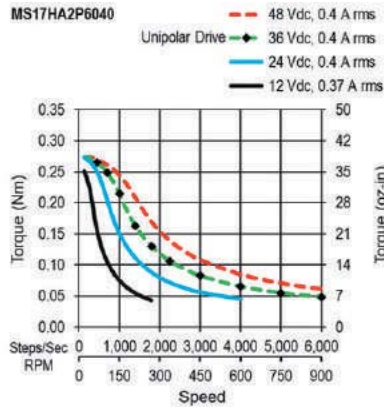
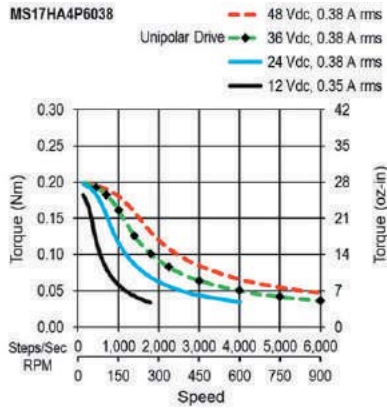

MS17HD Series: 1.8° - Size 17



- Phases 2
- Steps / Revolution 200
- Step Accuracy ±5%
- Shaft Load (20,000 Hours at 1000 RPM)
 - Axial 25 N (5.6 Lbs.) Push
65 N (15 Lbs.) Pull
 - Radial 29 N (6.5 Lbs.) At Flat Center
- IP Rating 40
- Approvals UL Recognized File E465363, RoHS
- Operating Temp. -20°C to +50°C
- Insulation Class B, 130°C
- Insulation Resistance 100 MegOhms

MS17HD 4 P 4 040 -M

Basic Motor Length (Max)

5	25.3mm (1.0 in.)	
4	34.3mm (1.35 in.)	
2	39.8mm (1.57 in.)	1 Stack
6	48.3mm (1.90 in.)	2 Stack
B	62.8mm (2.47 in.)	3 Stack

Electrical Connection

P Plug-in Connector

Number of Connections

4	4 Lead-Bipolar
6	6 Lead-Unipolar(or Bipolar)

Options

Omit	No Options
-M	5 mm Diameter Rear Shaft With Encoder Mounting Holes

Winding

Current rating x 100

Dimensions: mm (in)

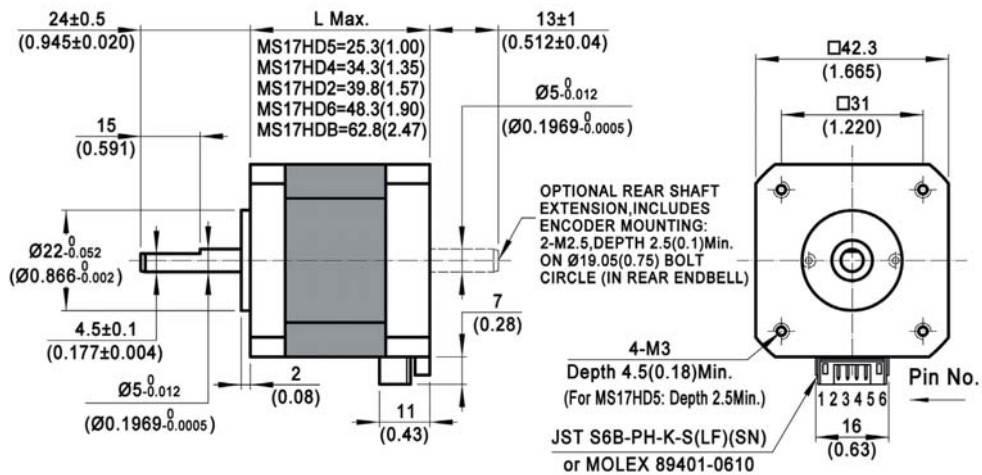
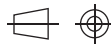

MS17HD - 4 Lead Bi-Polar

Length	Model Number	Connect	Rated Current	Holding Torque		Winding Ohms mH		Detent Torque		Rotor Inertia		Motor Weight	
	Single Shaft	P=Side Plug L=Leads	Amps (mounted)	Nm Typ.	oz-in TYP.	@20 C	Typ.	mNm	oz-in	g cm ²	oz-in ²	kg	Lbs
25.3 mm (1 in.)	MS17HD5P4027	P	0.27	0.20	28	42	50						
	^ MS17HD5P4070	P	0.7	0.21	30	6.2	8.3						
	^ MS17HD5P4100	P	1	0.21	30	3.1	4	5	0.71	20	0.11	0.15	0.33
	^ MS17HD5P4150	P	1.5	0.20	28	1.25	1.56						
34.3 mm (1.35 in.)	MS17HD4P4040	P	0.4	0.34	48	30	51						
	^ MS17HD4P4065	P	0.65	0.32	45	8.7	15.4						
	^ MS17HD4P4100	P	1	0.33	47	4.2	7.5	12	1.7	38	0.21	0.21	0.46
	^ MS17HD4P4150	P	1.5	0.32	45	1.7	2.9						
39.8 mm (1.57 in.) 1 Stack	MS17HD2P4040	P	0.4	0.48	68	24	56						
	^ MS17HD2P4100	P	1	0.48	68	3.9	8.9						
	^ MS17HD2P4150	P	1.5	0.50	71	1.98	4.3	15	2.1	57	0.31	0.28	0.62
	^ MS17HD2P4200	P	2	0.48	68	1.04	2.2						
48.3 mm (1.9 in.) 2 Stack	MS17HD6P4050	P	0.5	0.67	95	24	53						
	^ MS17HD6P4100	P	1	0.63	89	4.9	11.5						
	^ MS17HD6P4150	P	1.5	0.62	88	2.2	4.9	25	3.5	82	0.45	0.36	0.79
	^ MS17HD6P4200	P	2	0.63	89	1.3	2.9						
62.8 mm (2.47 in.) 3 Stack	^ MS17HDBP4100	P	1	0.82	120	5.6	14.6						
	^ MS17HDBP4150	P	1.5	0.88	120	3	7.7	30	4.2	123	0.67	0.6	1.3
	^ MS17HDBP4200	P	2	0.83	120	1.49	3.8						

^ Preferred model

MS17HD - 6 Lead Uni-Polar

Length	Model Number	Connect	Rated Current	Holding Torque		Winding Ohms mH		Detent Torque		Rotor Inertia		Motor Weight	
	Single Shaft	P=Side Plug L=Leads	Amps (mounted)	Nm Typ.	oz-in TYP.	@20 C	Typ.	mNm	oz-in	g cm ²	oz-in ²	kg	Lbs
25.3 mm (1 in.)	MS17HD5P6030	P	0.3	0.16	23	38	23						
	MS17HD5P6070	P	0.7	0.16	23	6.3	4.2	5	0.71	20	0.11	0.15	0.33
	MS17HD5P6100	P	1	0.16	23	3.2	2.1						
34.3 mm (1.35 in.)	MS17HD4P6038	P	0.38	0.26	37	31	27						
	MS17HD4P6085	P	0.85	0.24	34	5.1	4.5	12	1.7	38	0.21	0.21	0.46
	MS17HD4P6120	P	1.2	0.25	35	2.9	2.5						
39.8 mm (1.57 in.) 1 Stack	MS17HD2P6040	P	0.4	0.38	54	28	31						
	MS17HD2P6085	P	0.85	0.38	54	6	6.7	15	2.1	57	0.31	0.28	0.62
	MS17HD2P6130	P	1.3	0.38	54	2.5	2.8						
48.3 mm (1.9 in.) 2 Stack	MS17HD6P6040	P	0.4	0.48	68	29	33						
	MS17HD6P6080	P	0.8	0.49	69	7.6	8.6						
	MS17HD6P6130	P	1.3	0.51	72	3.2	3.6	25	3.5	82	0.45	0.36	0.79
	MS17HD6P6200	P	2	0.50	71	1.3	1.4						

^ Preferred model

Mating Connector With Leads (order separately)

Dimensions: mm (in)

4 Lead Part Number 4634140200723

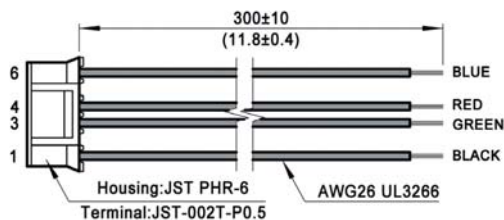

6 Lead Part Number 4634140200922

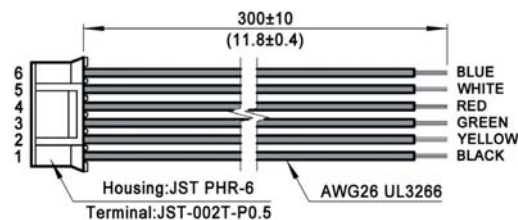

MS17HD5 - Bipolar

MS17HD4 - Bipolar

MS17HD2 - Bipolar

MS17HD6 - Bipolar

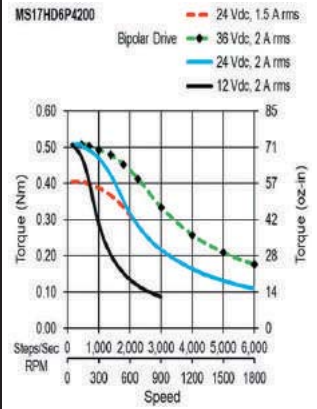
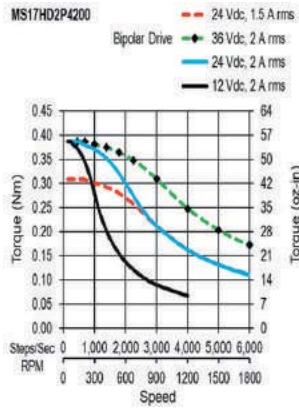
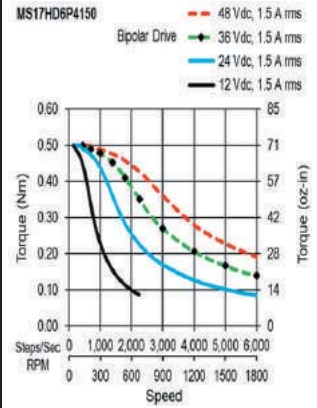
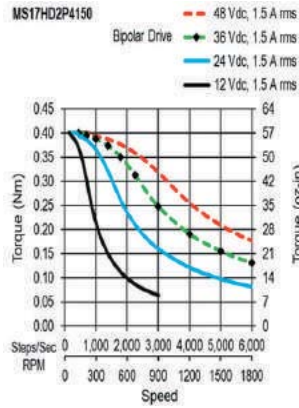
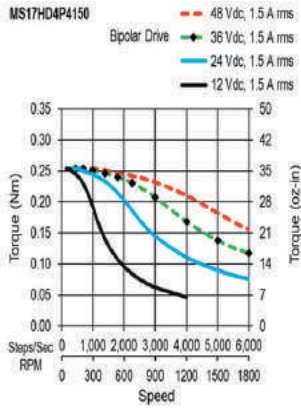
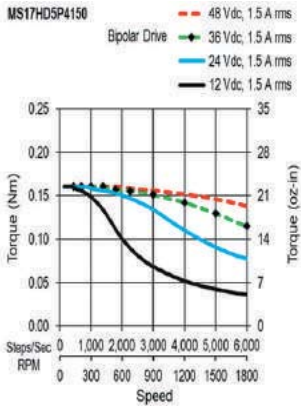
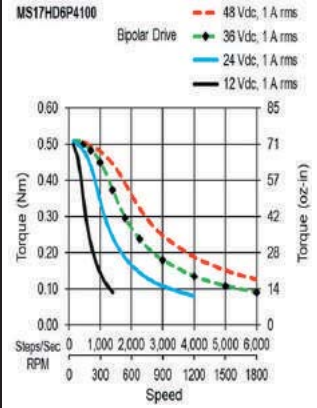
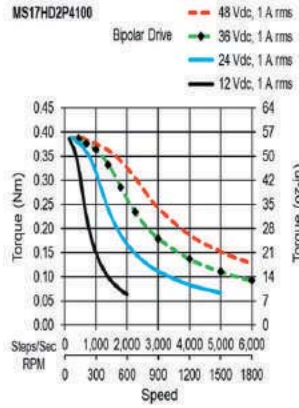
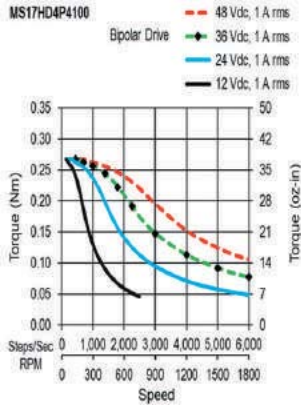
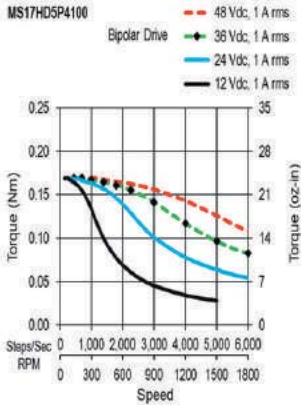
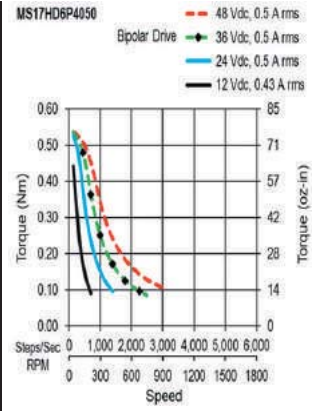
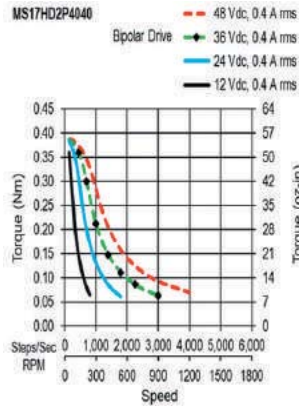
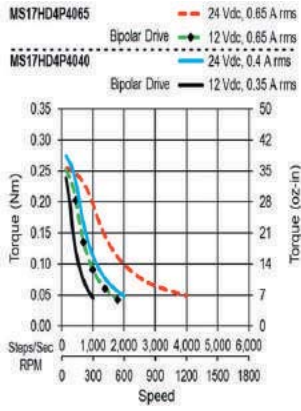
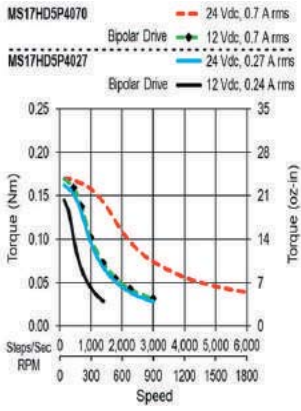

MOONS Technology

2 Phase Step Motors

3 Phase Step Motors

Technical

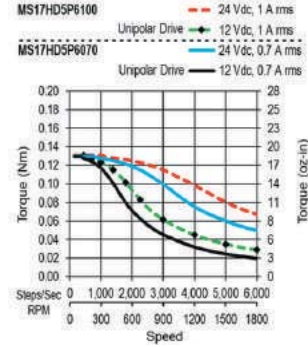
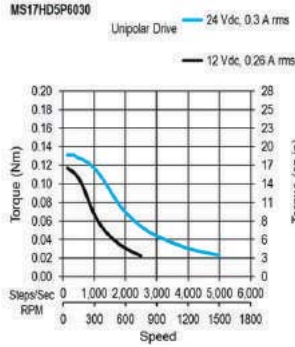

MS17HD4 - Unipolar

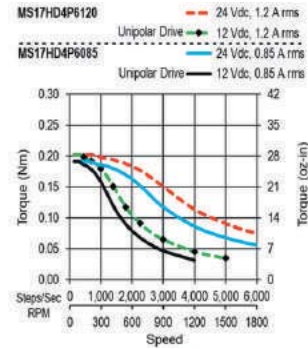
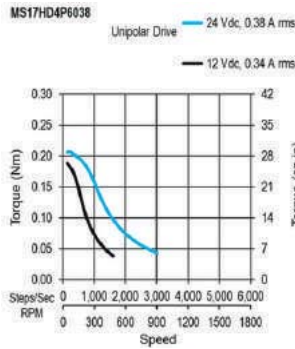
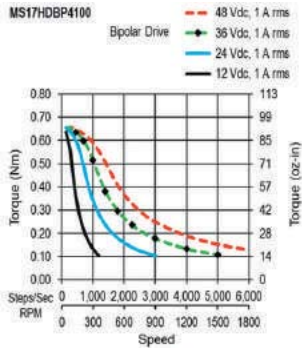

MS17HD2 - Unipolar

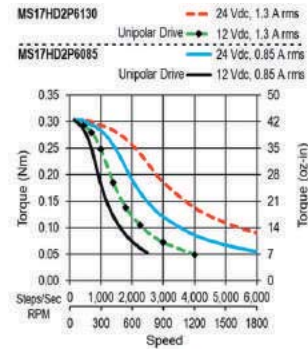
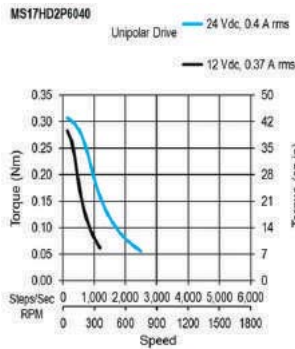
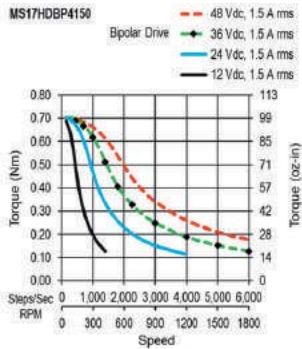

MS17HD6 - Unipolar

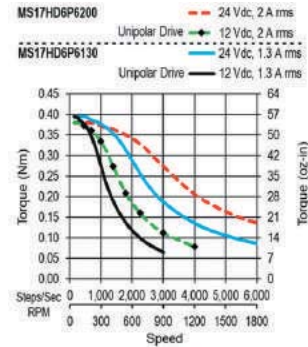
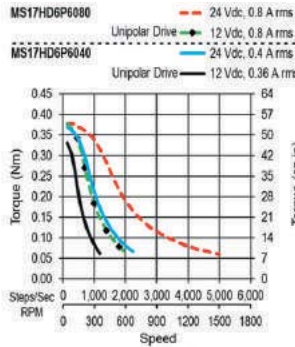
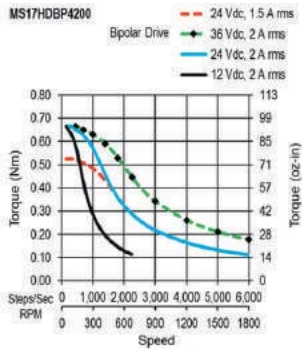

MS23HA Series: 0.9° - Size 23



- Phases 2
- Steps / Revolution 400
- Step Accuracy ±5%
- Shaft Load (20,000 Hours at 1000 RPM)
 - Axial 40 N (9 Lbs.) Push
130 N (30 Lbs.) Pull
 - Radial 70 N (15.5 Lbs.) At Flat Center
- IP Rating 40
- Approvals UL Recognized File E465363, RoHS
- Operating Temp. -20°C to +50°C
- Insulation Class B, 130°C
- Insulation Resistance 100 MegOhms

MS23HA 0 P 4 100 -E

Basic Motor Length (Max)

0	39mm (1.54 in.)	
8	55mm (2.17 in.)	1 Stack
A	77mm (3.03 in.)	2 Stack

Electrical Connection

P Plug-in Connector

Options

Omit	No Options
-E	0.25 inch diameter rear shaft With Encoder Mounting Holes

Winding

Current rating x 100

Number of Connections

4	4 Lead-Bipolar
6	6 Lead-Unipolar(or Bipolar)

MS23HA - 4 Lead Bi-Polar

Length	Model Number	Connect	Rated Current	Holding Torque		Winding		Detent Torque		Rotor Inertia		Motor Weight	
				Amps (mounted)	Nm Typ. oz-in TYP.	@20 C	Typ. mH	mNm	oz-in	g cm ²	oz-in ²	kg	Lbs
39 mm (1.54 in.)	^ MS23HA0P4100	P	1	0.70	99	6.3	23						
	^ MS23HA0P4160	P	1.6	0.71	100	2.6	9.2	24	3.4	121.5	0.66	0.42	0.93
	^ MS23HA0P4220	P	2.2	0.71	100	1.39	4.9						
	^ MS23HA0L4350	L	3.5	0.70	99	0.56	1.85						
55 mm (2.17 in.) 1 Stack	^ MS23HA8P4100	P	1	1.50	210	7.6	50						
	^ MS23HA8P4150	P	1.5	1.40	200	3.1	21						
	^ MS23HA8P4220	P	2.2	1.50	210	1.6	10.5	45	6.4	221	1.2	0.6	1.3
	^ MS23HA8L4360	L	3.6	1.50	210	0.63	3.9						
	^ MS23HA8L4550	L	5.5	1.50	210	0.28	1.56						
77 mm (3.03 in.) 2 Stack	^ MS23HAAP4100	P	1	2.30	330	8.8	61						
	^ MS23HAAP4150	P	1.5	2.40	340	4.3	29						
	^ MS23HAAP4200	P	2	2.30	330	2.3	15.2	70	9.9	391	2.1	1	2.2
	^ MS23HAAP4300	P	3	2.40	340	1.1	6.9						
	^ MS23HAAL4500	L	5	2.30	330	0.39	2.4						

^ Preferred model

Dimensions: mm (in)

Mating Connector with 4 Leads: 300 ±10 (12 ±.5) long (order separately) Part Number: 4634 1402 01891

Motors with leads: Lead wire is 22 AWG UL3266, 300 ±10 (12 ±.5) long

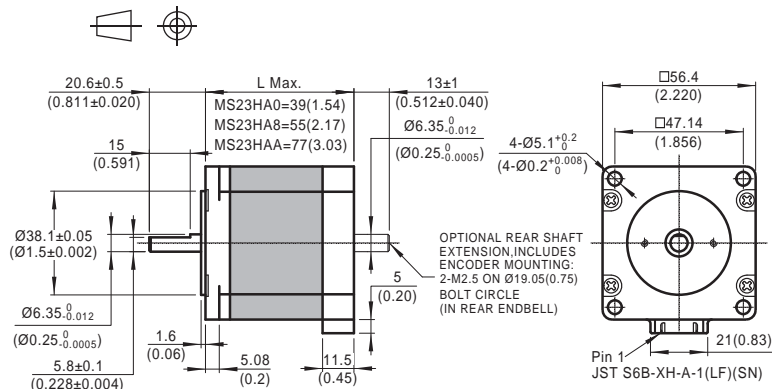

MS23HA0

MS23HA8

MS23HAA

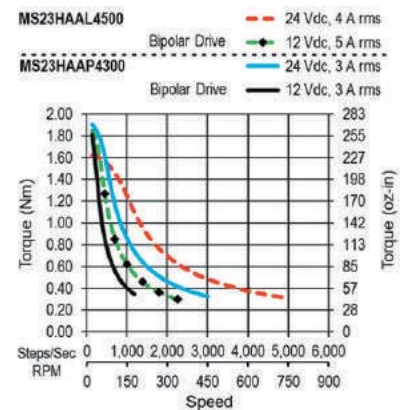
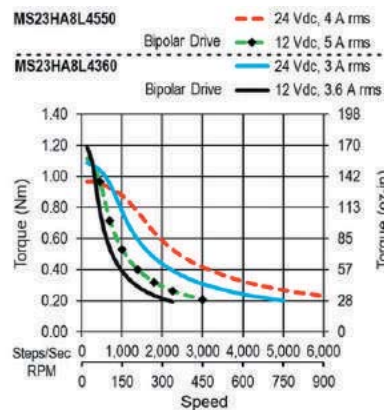
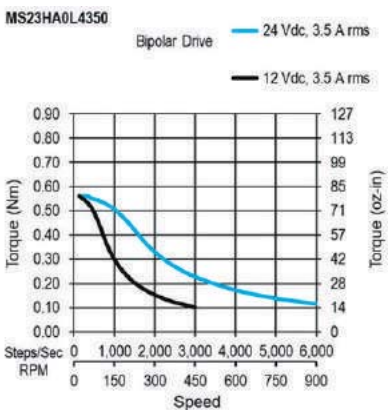
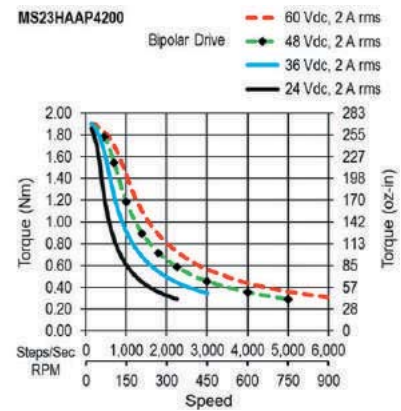
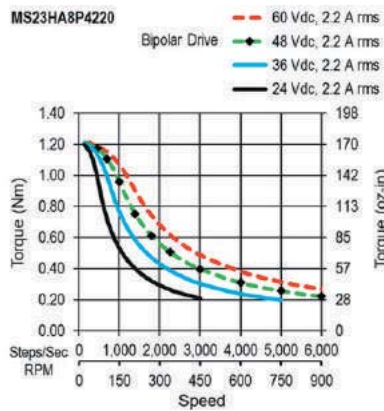
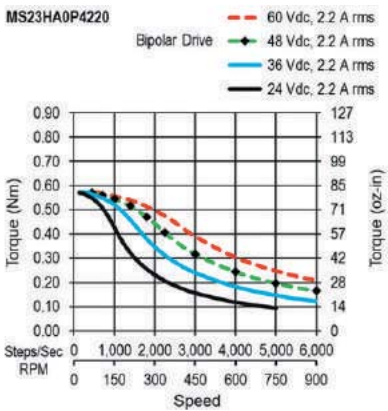
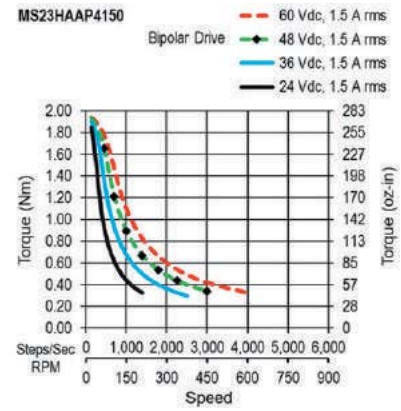
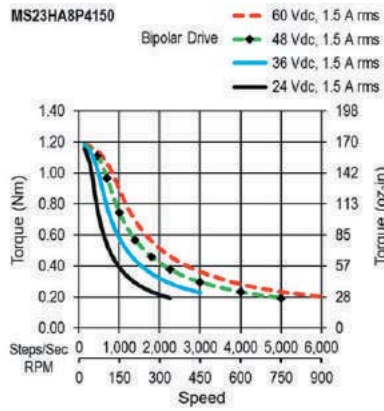
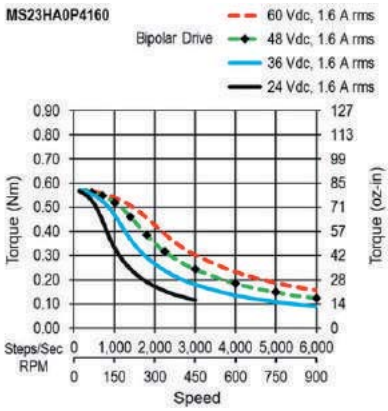
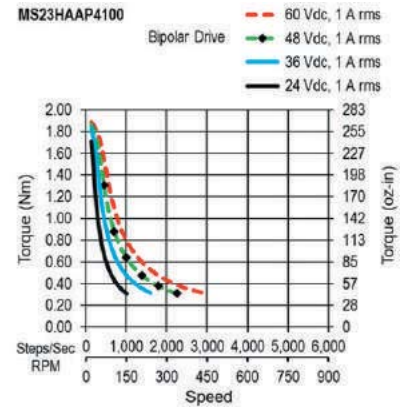
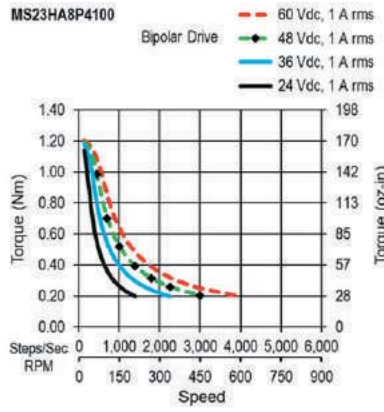
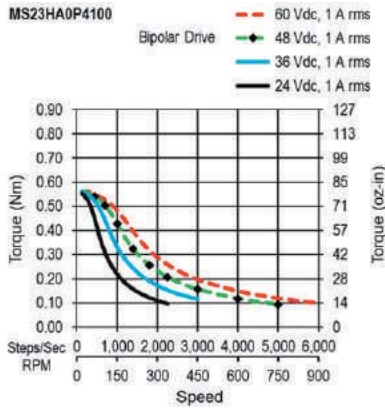

ML23HS / PL23HS Series: 1.8° - Size 23



- Phases 2
- Steps / Revolution 200
- Step Accuracy ±5%
- Shaft Load (20,000 Hours at 1000 RPM)
 - Axial 40 N (9 Lbs.) Push
130 N (30 Lbs.) Pull
 - Radial 70 N (15.5 Lbs.) At Flat Center
- IP Rating 40
- Approvals UL Recognized File E465363, RoHS
- Operating Temp. -20°C to +50°C
- Insulation Class B, 130°C
- Insulation Resistance 100 MegOhms

M L23HS 0 P 4 100 -E

Motor Technology

- M High Torque Step Motor
- P PowerPlus Step Motor

Basic Motor Length (Max)

0	39mm (1.54 in.)	
4	45mm (1.77 in.)	
8	55mm (2.17 in.)	1 Stack
A	77mm (3.03 in.)	2 Stack
C	112mm (4.41 in.)	3 Stack

Electrical Connection

- L Leads
- P Plug-in Connector

Options

- Omit No Options
- E 0.25 inch Diameter Rear Shaft with Encoder Mounting Holes

Winding

- ### Current rating x 100

Number of Connections

- 4 4 Lead-Bipolar
- 6 6 Lead-Unipolar(or Bipolar)

Dimensions: mm (in)

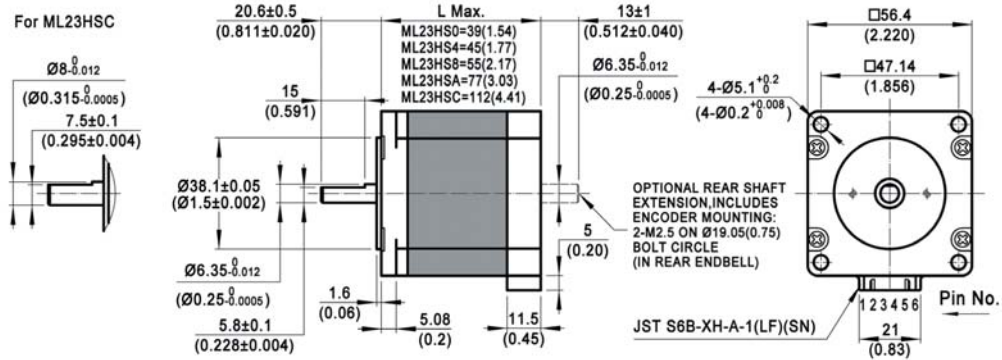
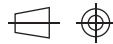

ML23HS - 4 Lead Bi-Polar

Length	Model Number	Connect	Rated Current	Holding Torque		Winding Ohms mH		Detent Torque		Rotor Inertia		Motor Weight	
	Single Shaft	P=Side Plug L=Leads	Amps (mounted)	Nm Typ.	oz-in TYP.	@20 C	Typ.	mNm	oz-in	g cm ²	oz-in ²	kg	Lbs
39 mm (1.54 in.)	^ ML23HS0P4100	P	1	0.82	120	6.3	15.9						
	^ ML23HS0P4160	P	1.6	0.83	120	2.6	6.5						
	^ ML23HS0P4220	P	2.2	0.84	120	1.39	3.5	24	3.4	121.5	0.66	0.42	0.93
	^ ML23HS0L4350	L	3.5	0.82	120	0.56	1.3						
45 mm (1.77 in.)	^ ML23HS4P4100	P	1	1.20	170	7.3	22						
	^ ML23HS4P4150	P	1.5	1.20	170	3.1	9.2						
	^ ML23HS4P4210	P	2.1	1.20	170	1.62	4.8	28	4	155	0.85	0.48	1.1
	^ ML23HS4L4340	L	3.4	1.20	170	0.65	1.8						
55 mm (2.17 in.) 1 Stack	^ ML23HS8P4100	P	1	1.50	210	7.6	33						
	^ ML23HS8P4150	P	1.5	1.50	210	3.1	13.6						
	^ ML23HS8P4220	P	2.2	1.50	210	1.6	6.9	45	6.4	221	1.2	0.6	1.3
	^ ML23HS8L4360	L	3.6	1.50	210	0.63	2.6						
	^ ML23HS8L4550	L	5.5	1.50	210	0.28	1.03						
77 mm (3.03 in.) 2 Stack	^ ML23HSAP4100	P	1	2.30	330	8.8	39						
	^ ML23HSAP4150	P	1.5	2.30	330	4.3	18.5						
	^ ML23HSAP4200	P	2	2.30	330	2.3	9.8	75	11	391	2.1	1	2.2
	^ ML23HSAP4300	P	3	2.30	330	1.1	4.5						
	^ ML23HSAL4500	L	5	2.30	330	0.39	1.53						
112 mm (4.41 in.) 3 Stack	^ ML23HSCP4150	P	1.5	3.20	450	5.1	27						
	^ ML23HSCP4200	P	2	3.20	450	2.7	13.7						
	^ ML23HSCP4300	P	3	3.20	450	1.29	6.4	120	17	610	3.3	1.5	3.3
	^ ML23HSCL4500	L	5	3.20	450	0.51	2.1						

^ Preferred model

PL23HS - PowerPlus - 4 Lead Bi-Polar

Length	Model Number	Connect	Rated Current	Holding Torque		Winding Ohms mH		Detent Torque		Rotor Inertia		Motor Weight	
	Single Shaft	P=Side Plug L=Leads	Amps (mounted)	Nm Typ.	oz-in TYP.	@20 C	Typ.	mNm	oz-in	g cm ²	oz-in ²	kg	Lbs
55 mm (2.17 in.) 1 Stack	^ PL23HS8P4100	P	1	2.30	330	7.6	26						
	^ PL23HS8P4150	P	1.5	2.20	310	3.1	10.7						
	^ PL23HS8P4220	P	2.2	2.30	330	1.6	5.4	100	14	260	1.4	0.65	1.4
	^ PL23HS8L4360	L	3.6	2.30	330	0.63	2						
	^ PL23HS8L4550	L	5.5	2.20	310	0.28	0.8						
77 mm (3.03 in.) 2 Stack	^ PL23HSAP4100	P	1	3.30	470	8.8	32						
	^ PL23HSAP4150	P	1.5	3.40	480	4.3	15.2						
	^ PL23HSAP4200	P	2	3.30	470	2.3	8.1	150	21	460	2.5	1.1	2.4
	^ PL23HSAP4300	P	3	3.30	470	1.1	3.7						
	^ PL23HSAL4500	L	5	3.30	470	0.39	1.27						

^ Preferred model

Mating Connector With Leads (order separately)

Dimensions: mm (in)

4 Lead Part Number 4634140201891

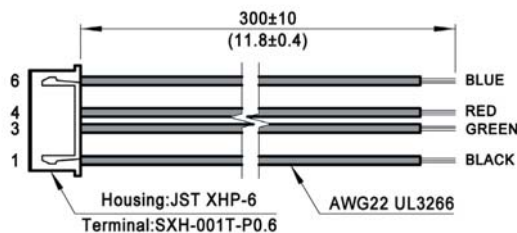

ML23HS0

ML23HS4

ML23HS8

ML23HSA

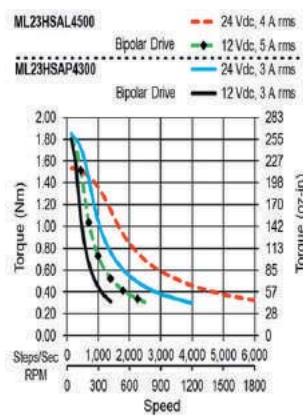
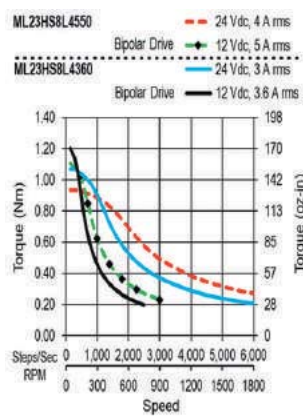
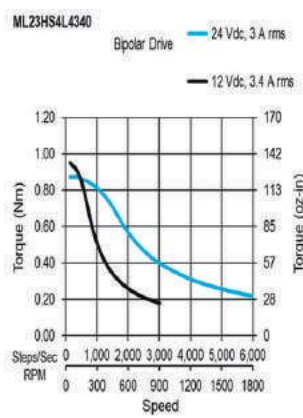
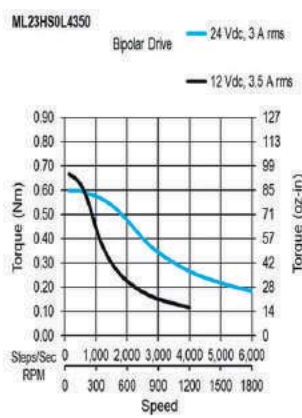
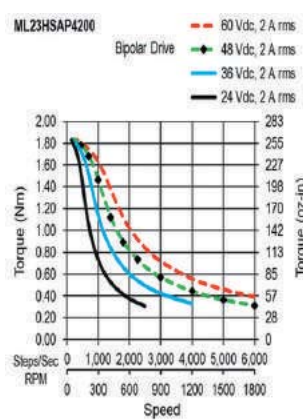
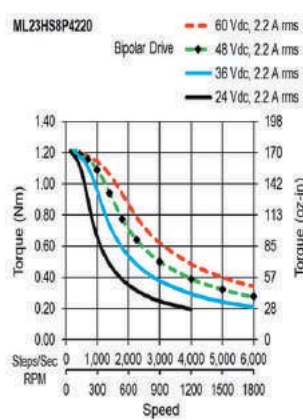
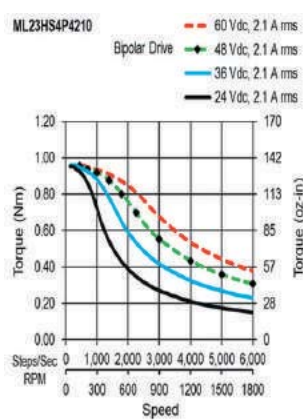
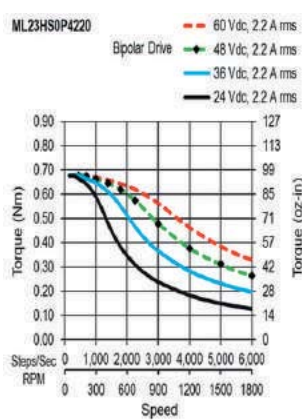
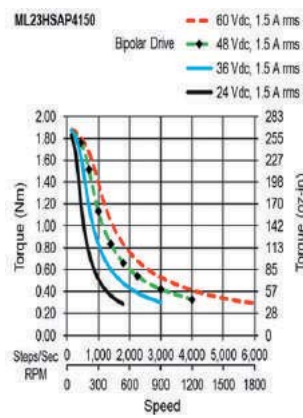
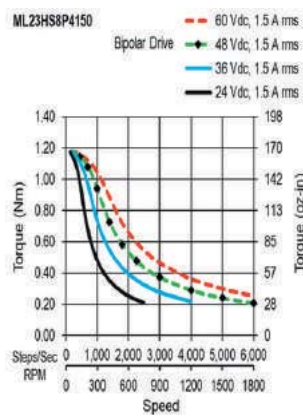
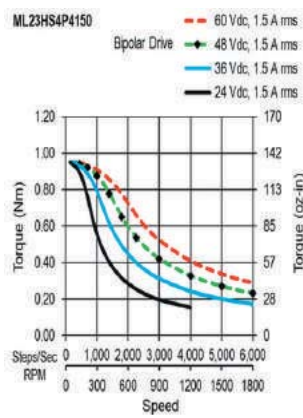
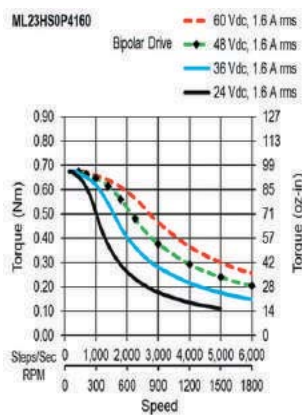
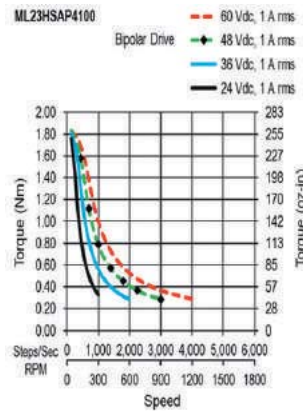
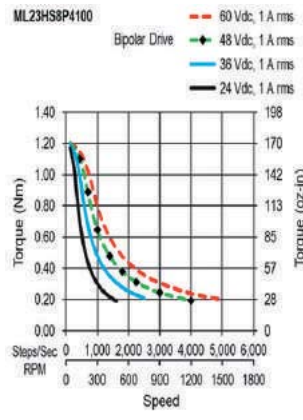
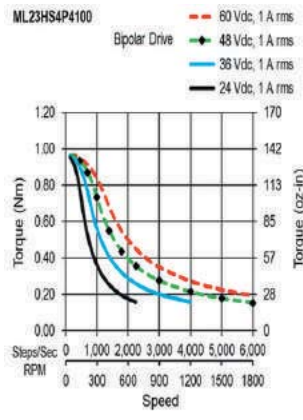
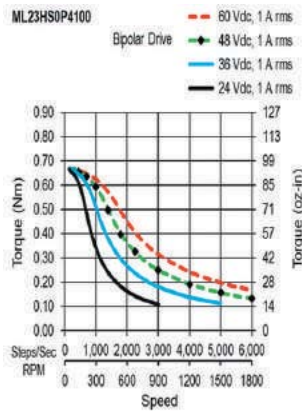

ML23HSC

PowerPlus PL23HS8

PowerPlus PL23HSA

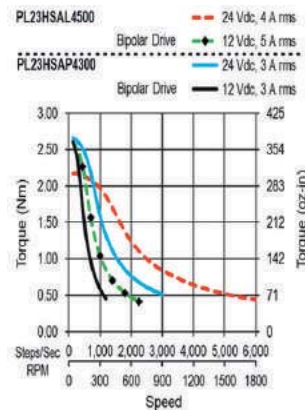
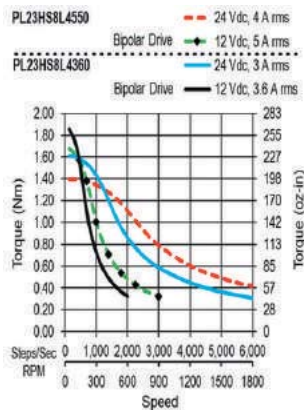
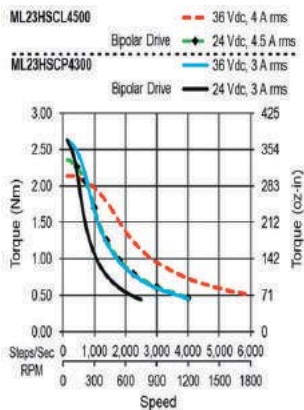
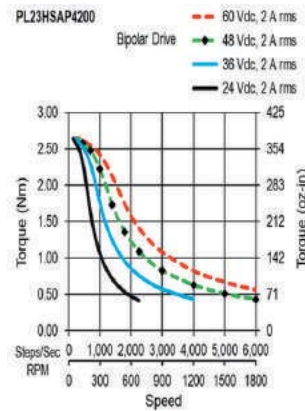
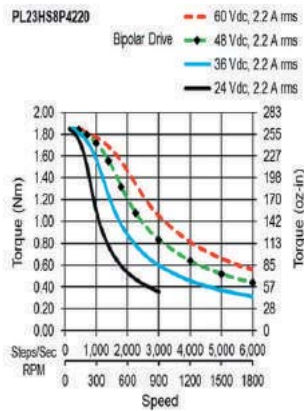
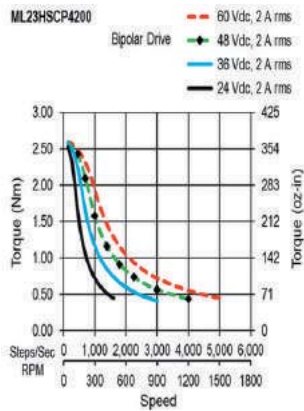
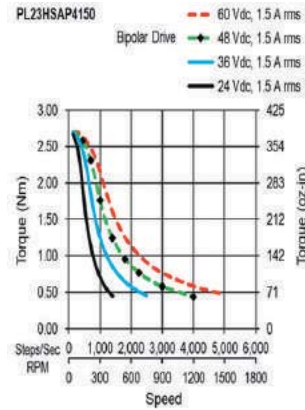
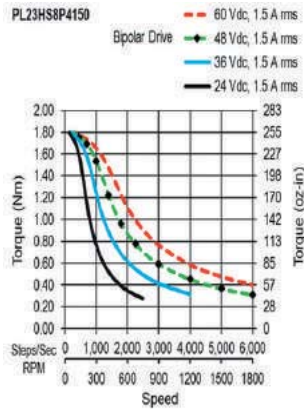
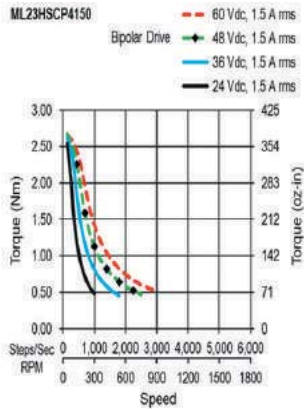
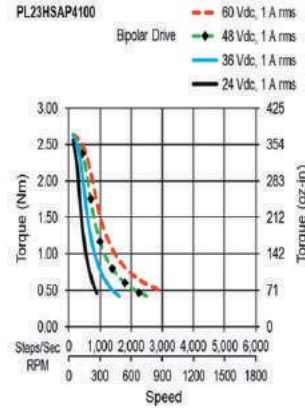
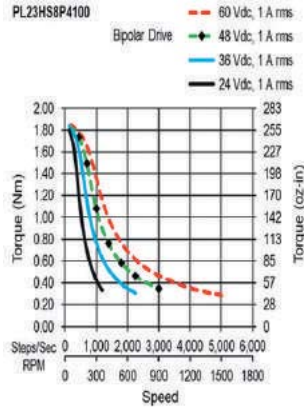

MS24HS1

MS24HS2

MS24HS3

MS24HS5

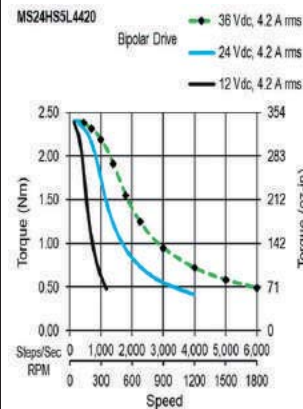
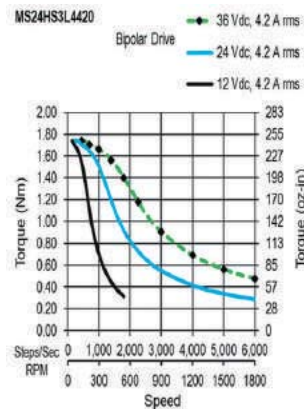
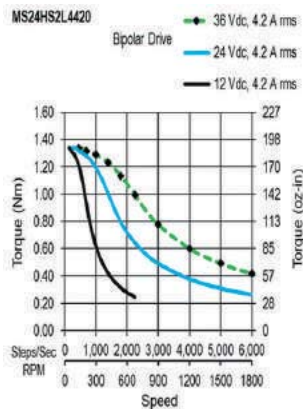
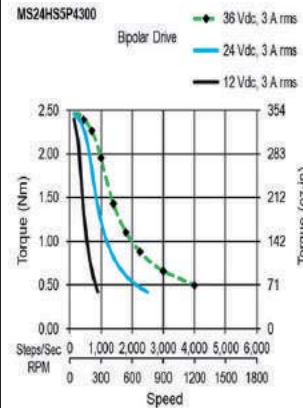
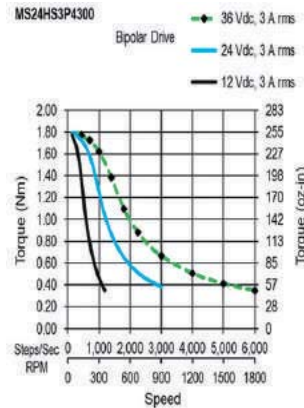
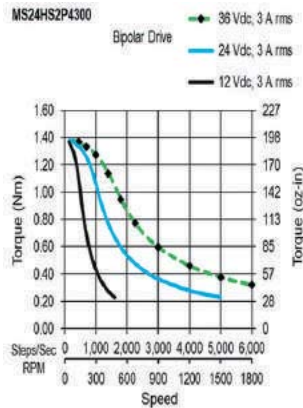
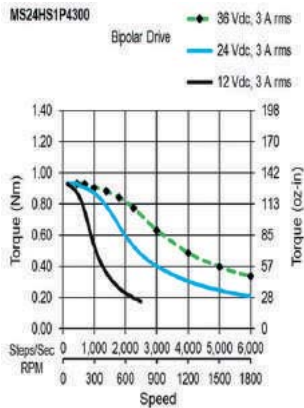
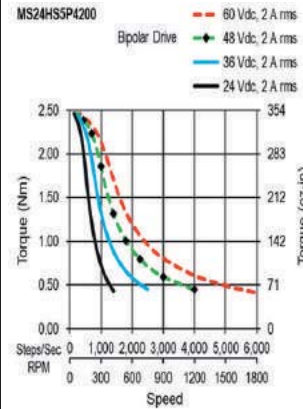
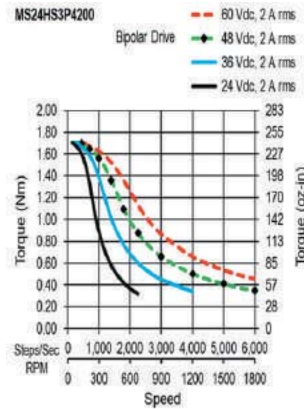
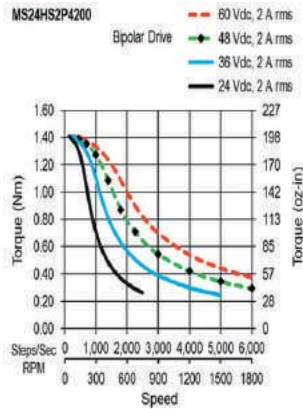
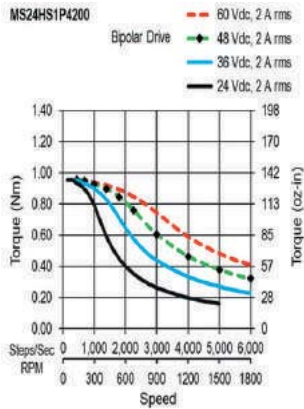
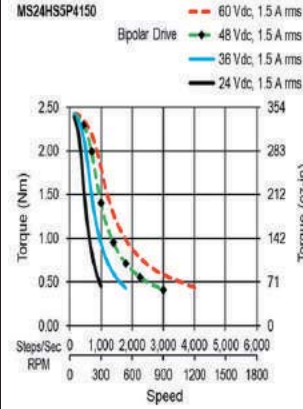
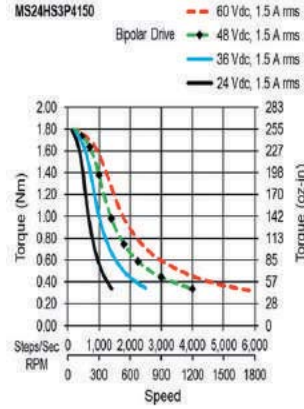
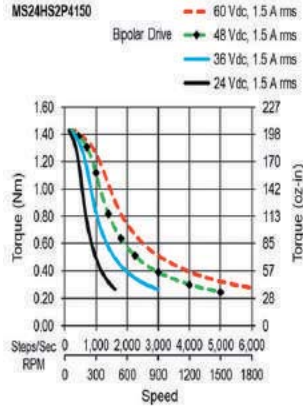
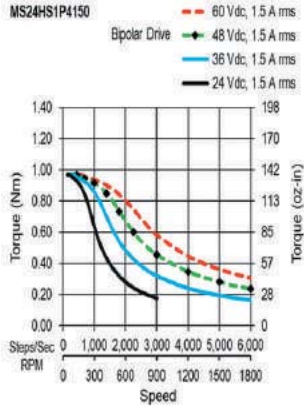

ML34HD / PL34HD Series: 1.8° - Size 34



- Phases 2
- Steps / Revolution 200
- Step Accuracy ±5%
- Shaft Load (20,000 Hours at 1000 RPM)
 - Axial 65 N (15 Lbs.) Push
155 N (35 Lbs.) Pull
 - Radial 220 N (50 Lbs.) At Flat Center
- IP Rating 40
- Approvals UL Recognized File E465363, RoHS
- Operating Temp. -20°C to +50°C
- Insulation Class B, 130°C

M L34HD 0 L 8 350 -E

Motor Technology

- M High Torque Step Motor
- P PowerPlus Step Motor

Basic Motor Length (Max)

0	67mm (2.64 in.)	1 Stack
1	97mm (3.82 in.)	2 Stack
2	126mm (4.96 in.)	3 Stack
3	157mm (6.18 in.)	4 Stack

L Leads

Options

- Omit No Options
- E 0.375 inch Diameter Rear Shaft with Encoder Mounting Holes

Winding

- ### Current rating x 100
- X## for 11 to 19 amps:
X10= 11 amps, X40 = 14 amps

Number of Connections

- 4 4 Lead-Bipolar
- 8 8 Lead-Unipolar(or Bipolar)

MS34HD – 4 Lead & 8 Lead

Length	Model Number	Connect	Rated Current	Holding Torque		Winding		Detent Torque		Rotor Inertia		Motor Weight	
				Amps (mounted)	Nm Typ. oz-in TYP.	@20 C	Typ.	mNm	oz-in	g cm ²	oz-in ²	kg	Lbs
67 mm (2.64 in.) 1 Stack	^ ML34HD0L4160	L	1.6	3.70	520	3.9	42						
	ML34HD0L4350	L	3.5	3.80	540	0.95	9.5						
	ML34HD0L4500	L	5	3.80	540	0.48	4.5	90	13	915	5	1.6	3.5
	ML34HD0L4700	L	7	3.80	540	0.26	2.4						
	ML34HD0L4X00	L	10	3.80	540	0.14	1.13						
97 mm (3.82 in.) 2 Stack	^ ML34HD1L4200	L	2	7.20	1,000	3.6	50						
	ML34HD1L4350	L	3.5	7.20	1,000	1.34	15.9						
	ML34HD1L4500	L	5	7.20	1,000	0.61	8	150	21	1480	8.1	2.7	6
	ML34HD1L4700	L	7	7.20	1,000	0.36	4						
	ML34HD1L4X00	L	10	7.20	1,000	0.19	2						
126 mm (4.96 in.) 3 Stack	^ ML34HD2L4200	L	2	10.00	1,400	4.1	59						
	ML34HD2L4350	L	3.5	9.90	1,400	1.44	18.7						
	ML34HD2L4500	L	5	9.80	1,400	0.72	8.7	200	28	2200	12	3.8	8.4
	ML34HD2L4700	L	7	9.90	1,400	0.38	4.7						
	ML34HD2L4X00	L	10	9.80	1,400	0.22	2.2						
157 mm (6.18 in.) 4 Stack	^ ML34HD3L4230	L	2.3	13.20	1,900	3.9	58						
	ML34HD3L4350	L	3.5	13.20	1,900	1.81	25						
	ML34HD3L4500	L	5	13.20	1,900	0.9	11.7	250	35	3110	17	4.9	11
	ML34HD3L4700	L	7	13.20	1,900	0.47	6.3						
	ML34HD3L4X00	L	10	13.20	1,900	0.24	2.9						
67 mm (2.64 in.) 1 Stack	^ ML34HD0L8350	L Series	3.5	3.80	540	0.98	9.5						
		L Parallel	7	3.80	540	0.25	2.4	90	13	915	5	1.6	3.5
	^ ML34HD0L8500	L Series	5	3.80	540	0.5	4.5						
L Parallel		10	3.80	540	0.126	1.13							
97 mm (3.82 in.) 2 Stack	^ ML34HD1L8350	L Series	3.5	7.20	1,000	1.37	15.9						
		L Parallel	7	7.20	1,000	0.34	4	150	21	1480	8.1	2.7	6
	^ ML34HD1L8500	L Series	5	7.20	1,000	0.71	8						
L Parallel		10	7.20	1,000	0.177	2							
126 mm (4.96 in.) 3 Stack	^ ML34HD2L8350	L Series	3.5	9.90	1,400	1.48	18.7						
		L Parallel	7	9.90	1,400	0.37	4.7	200	28	2200	12	3.8	8.4
	^ ML34HD2L8500	L Series	5	9.80	1,400	0.82	8.7						
		L Parallel	10	9.80	1,400	0.21	2.2						
157 mm (6.18 in.) 4 Stack	^ ML34HD3L8350	L Series	3.5	13.20	1,900	1.85	23						
		L Parallel	7	13.20	1,900	0.46	5.9	250	35	3110	17	4.9	11
	^ ML34HD3L8500	L Series	5	13.20	1,900	0.92	10.9						
		L Parallel	10	13.20	1,900	0.23	2.7						

^ Preferred model

Dimensions: mm (in)

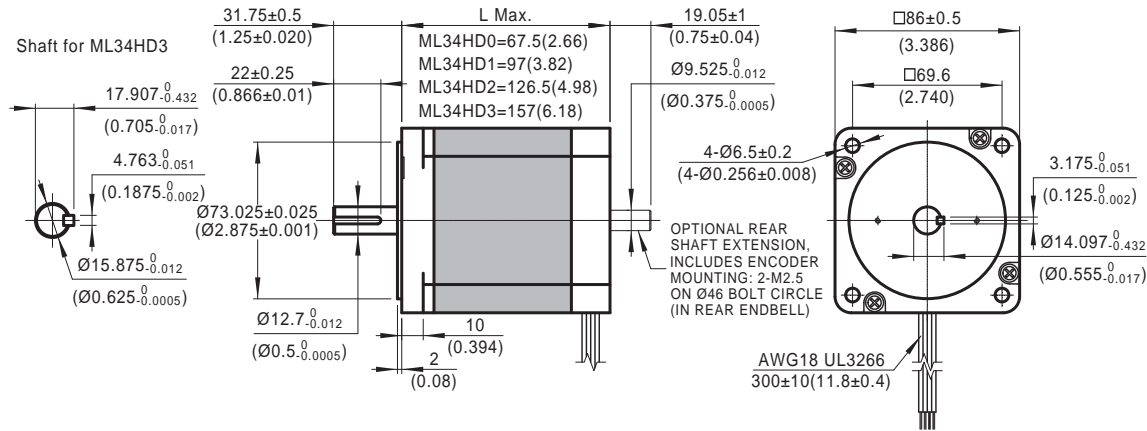
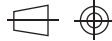

PL34HD – PowerPlus – 4 Lead & 8 Lead

Length	Model Number	Connect	Rated Current	Holding Torque		Winding		Detent Torque		Rotor Inertia		Motor Weight	
						Ohms	mH						
	Single Shaft	P=Side Plug L=Leads	Amps (mounted)	Nm Typ.	oz-in TYP.	@20 C	Typ.	mNm	oz-in	g cm ²	oz-in ²	kg	Lbs
67 mm (2.64 in.) 1 Stack	^ PL34HD0L4160	L	1.6	4.70	670	3.9	33						
	PL34HD0L4350	L	3.5	4.75	670	0.95	7.6						
	PL34HD0L4500	L	5	4.75	670	0.48	3.6	120	17	915	5	1.6	3.5
	PL34HD0L4700	L	7	4.75	670	0.26	1.89						
	PL34HD0L4X00	L	10	4.75	670	0.138	0.91						
97 mm (3.82 in.) 2 Stack	^ PL34HD1L4200	L	2	9.20	1,300	3.6	40						
	PL34HD1L4350	L	3.5	9.00	1,300	1.34	12.8						
	PL34HD1L4500	L	5	9.00	1,300	0.61	6.4	250	35	1480	8.1	2.7	6
	PL34HD1L4700	L	7	9.00	1,300	0.36	3.2						
	PL34HD1L4X00	L	10	9.00	1,300	0.188	1.6						
126 mm (4.96 in.) 3 Stack	^ PL34HD2L4200	L	2	12.30	1,700	4.1	44						
	PL34HD2L4350	L	3.5	12.30	1,700	1.44	14						
	PL34HD2L4500	L	5	12.30	1,700	0.72	6.5	300	42	2200	12	3.8	8.4
	PL34HD2L4700	L	7	12.30	1,700	0.38	3.5						
	PL34HD2L4X00	L	10	12.30	1,700	0.22	1.62						
157 mm (6.18 in.) 4 Stack	^ PL34HD3L4230	L	2.3	15.00	2,100	3.9	47						
	PL34HD3L4350	L	3.5	15.00	2,100	1.81	20						
	PL34HD3L4500	L	5	15.00	2,100	0.9	9.4	375	53	3110	17	4.9	11
	PL34HD3L4700	L	7	15.00	2,100	0.47	5						
	PL34HD3L4X00	L	10	15.00	2,100	0.24	2.3						
67 mm (2.64 in.) 1 Stack	^ PL34HD0L8350	L Series	3.5	4.75	670	0.98	7.6						
	PL34HD0L8500	L Parallel	7	4.75	670	0.25	1.89	120	17	915	5	1.6	3.5
97 mm (3.82 in.) 2 Stack	^ PL34HD1L8350	L Series	3.5	9.00	1,300	1.37	12.8						
	PL34HD1L8500	L Parallel	7	9.00	1,300	0.34	3.2	250	35	1480	8.1	2.7	6
126 mm (4.96 in.) 3 Stack	^ PL34HD2L8350	L Series	3.5	12.30	1,700	1.48	14						
	PL34HD2L8500	L Parallel	7	12.30	1,700	0.37	3.5	300	42	2200	12	3.8	8.4
157 mm (6.18 in.) 4 Stack	^ PL34HD3L8350	L Series	3.5	15.00	2,100	1.85	20						
	PL34HD3L8500	L Parallel	7	15.00	2,100	0.46	5	375	53	3110	17	4.9	11

^ Preferred model

ML34HD0

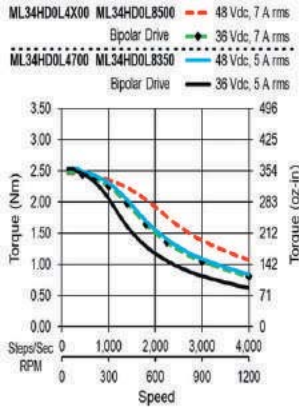
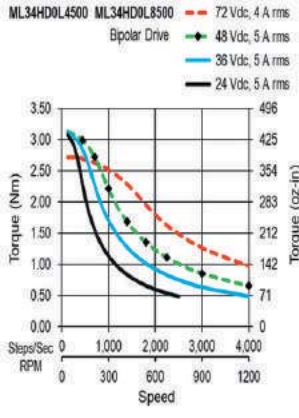
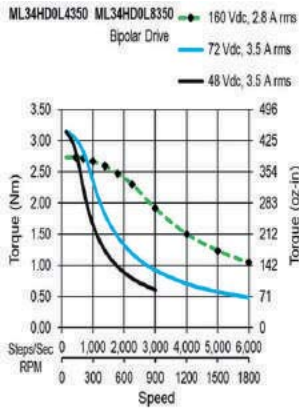
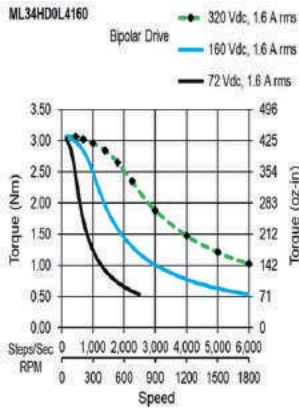

ML34HD1

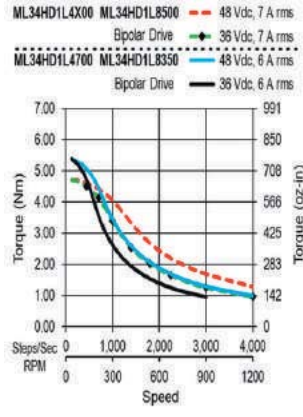
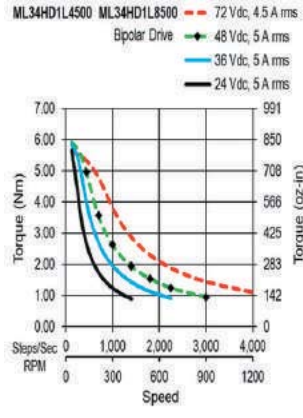
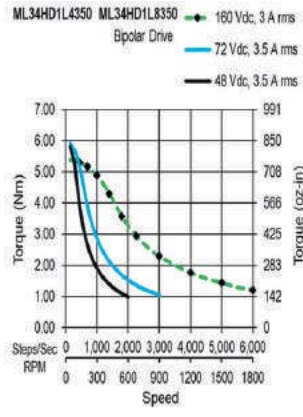
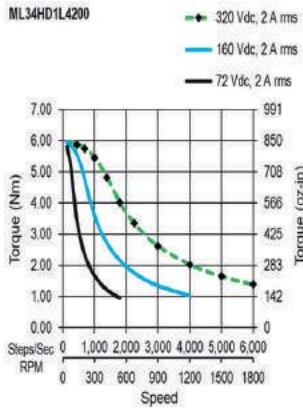

ML34HD2

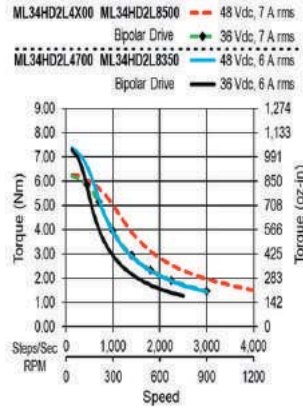
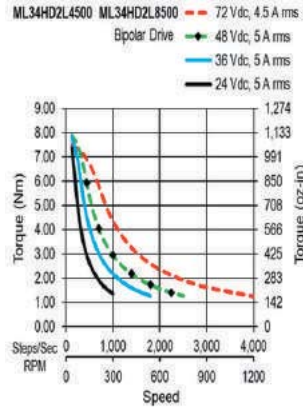
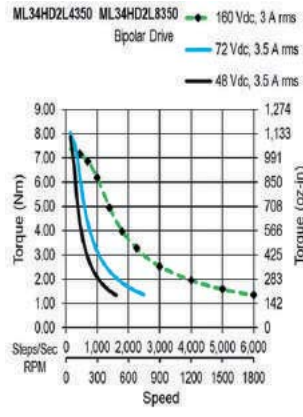
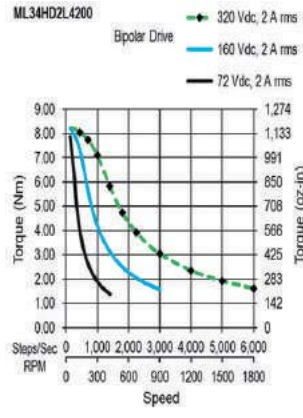

ML34HD3

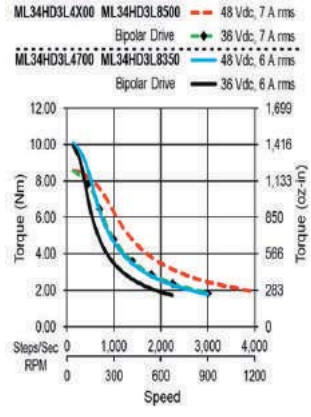
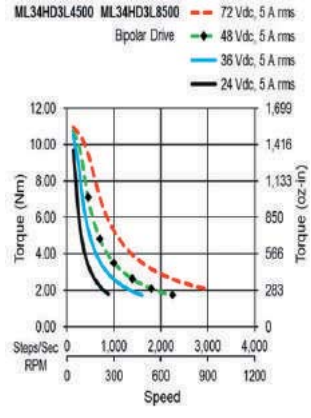
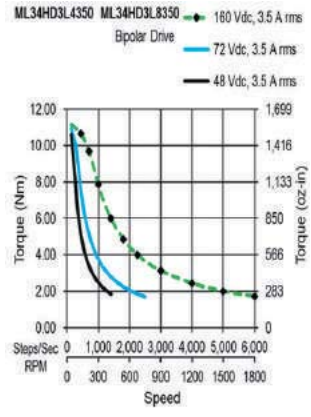
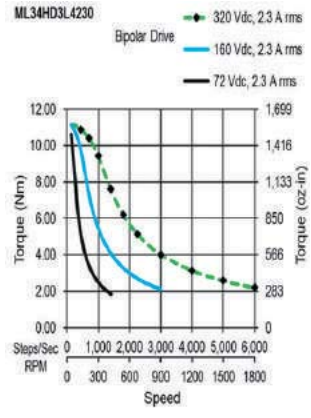

PL34HD0

PL34HD1

PL34HD2

PL34HD3

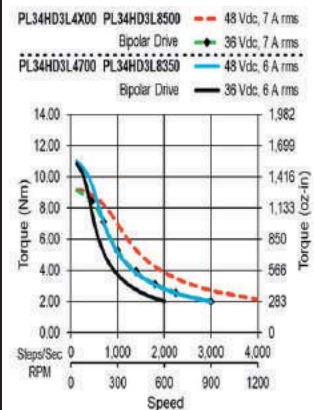
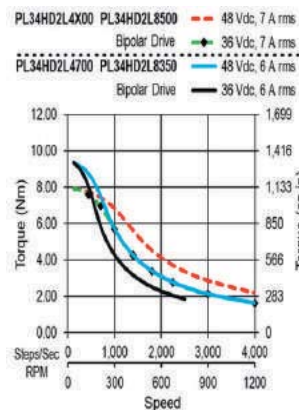
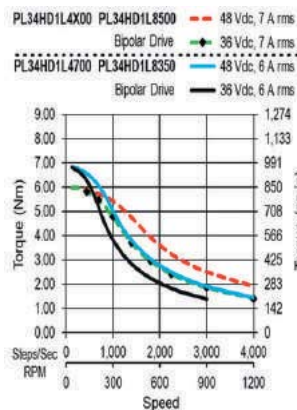
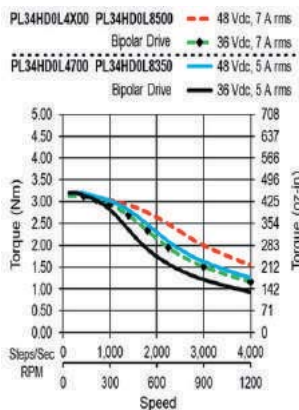
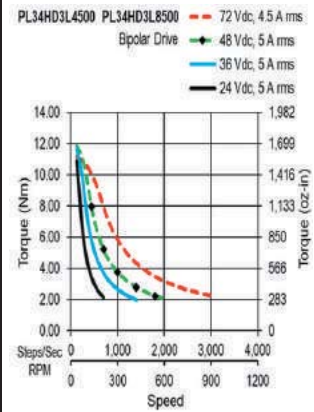
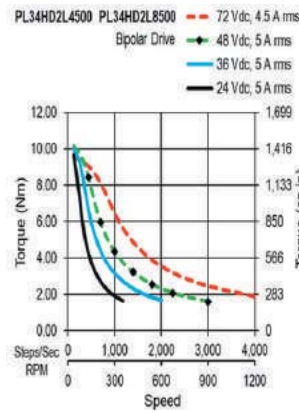
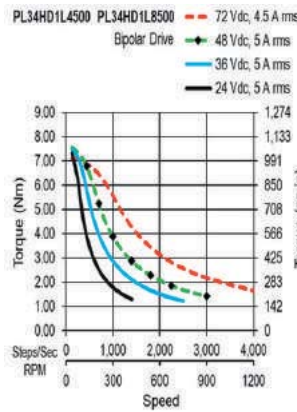
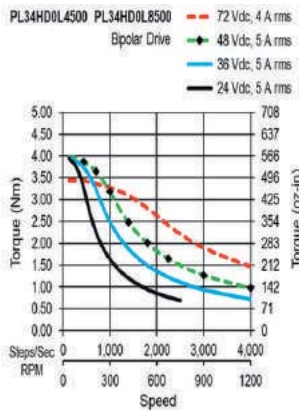
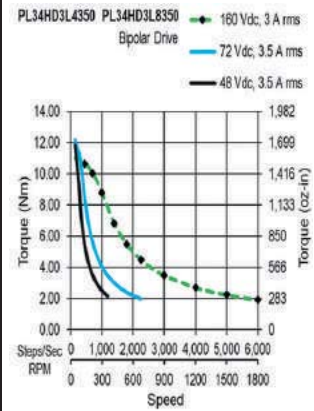
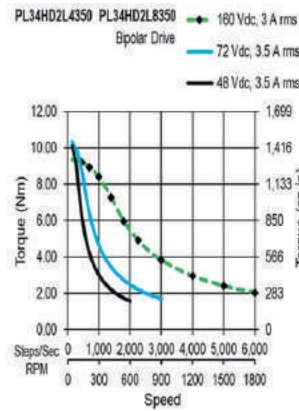
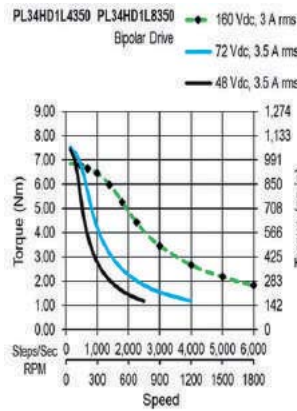
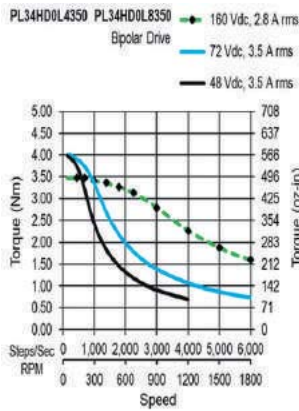
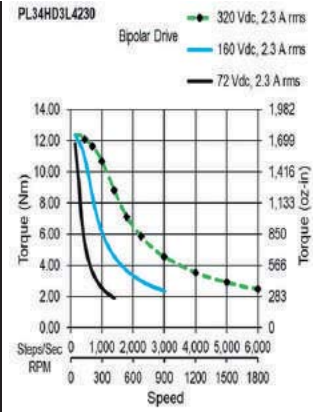
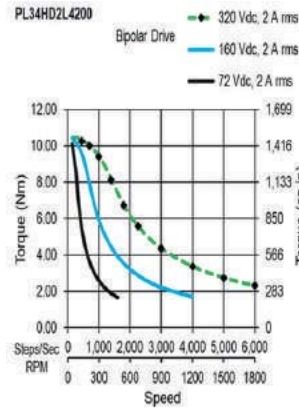
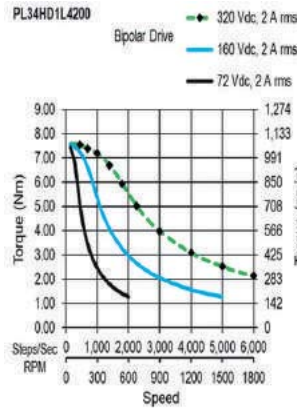
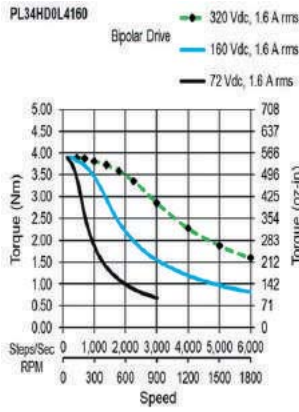

ML42HS Series: 1.8° - Size 42

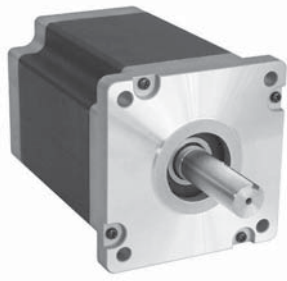

- Phases 2
- Steps / Revolution 200
- Step Accuracy ±5%
- Shaft Load (20,000 Hours at 1000 RPM)
 - Axial 250 N (56 Lbs.) Push & Pull
 - Radial 450 N (100 Lbs.) At Keyway Center
- IP Rating 40
- Approvals UL Recognized File E465363, RoHS
- Operating Temp. - 20°C to +40°C
- Insulation Class B, 130°C
- Insulation Resistance 100 MegOhms

M L42HS 0 L 8 350

Motor Technology

- M High Torque Step Motor
- P PowerPlus Step Motor

Basic Motor Length (Max)

0	100mm (3.94 in.)	1 Stack
2	151mm (5.95 in.)	2 Stack
3	202mm (7.95 in.)	3 Stack

Electrical Connection

L Leads

Winding

- ### Current rating x 100
- X## for 11 to 19 amps:
- X10= 11 amps, X40 = 14 amps

Number of Connections

- 4 4 Lead-Bipolar
- 8 8 Lead-Unipolar(or Bipolar)

ML42HS – 4 Lead & 8 Lead

Length	Model Number	Connect	Rated Current	Holding Torque		Winding		Detent Torque		Rotor Inertia		Motor Weight	
				Amps (mounted)	Nm Typ.	oz-in TYP.	@20 C	Typ.	mNm	oz-in	g cm ²	oz-in ²	kg
100 mm (3.94 in.) 1 Stack	^ ML42HS0L4210	L	2.1	12.10	1,700	4.1	69						
	ML42HS0L4420	L	4.2	12.20	1,700	1.16	17.4						
	ML42HS0L4600	L	6	12.30	1,700	0.61	8.9	500	71	5500	30	4.8	11
	ML42HS0L4840	L	8.4	12.20	1,700	0.31	4.4						
	ML42HS0L4X20	L	12	12.30	1,700	0.167	2.2						
151 mm (5.94 in.) 2 Stack	^ ML42HS2L4240	L	2.4	22.00	3,100	4.2	78						
	ML42HS2L4600	L	6	22.00	3,100	0.75	12.4						
	ML42HS2L4800	L	8	22.00	3,100	0.41	7.3	650	92	10900	60	8	18
	ML42HS2L4X20	L	12	22.00	3,100	0.177	3.1						
	ML42HS2L4X60	L	16	22.00	3,100	0.116	1.82						
202 mm (7.95 in.) 3 Stack	^ ML42HS3L4270	L	2.7	31.00	4,400	4.2	84						
	ML42HS3L4600	L	6	31.00	4,400	1.02	18.6						
	ML42HS3L4800	L	8	32.00	4,500	0.55	10.9	800	110	16200	89	11.6	26
	ML42HS3L4X20	L	12	31.00	4,400	0.24	4.7						
	ML42HS3L4X60	L	16	32.00	4,500	0.152	2.7						
100 mm (3.94 in.) 1 Stack	ML42HS0L8420	L Series	4.2	12.20	1,700	1.19	17.4						
		L Parallel	8.4	12.20	1,700	0.3	4.4						
	ML42HS0L8600	L Series	6	12.30	1,700	0.64	8.9	500	71	5500	30	4.8	11
		L Parallel	12	12.30	1,700	0.159	2.2						
151 mm (5.94 in.) 2 Stack	ML42HS2L8600	L Series	6	22.00	3,100	0.68	12.4						
		L Parallel	12	22.00	3,100	0.17	3.1	650	92	10900	60	8	18
	ML42HS2L8800	L Series	8	22.00	3,100	0.43	7.3						
		L Parallel	16	22.00	3,100	0.108	1.82						
202 mm (7.95 in.) 3 Stack	ML42HS3L8600	L Series	6	31.00	4,400	0.91	18.6						
		L Parallel	12	31.00	4,400	0.23	4.7	800	110	16200	89	11.6	26
	ML42HS3L8800	L Series	8	32.00	4,500	0.58	10.9						
		L Parallel	16	32.00	4,500	0.144	2.7						

^ Preferred model

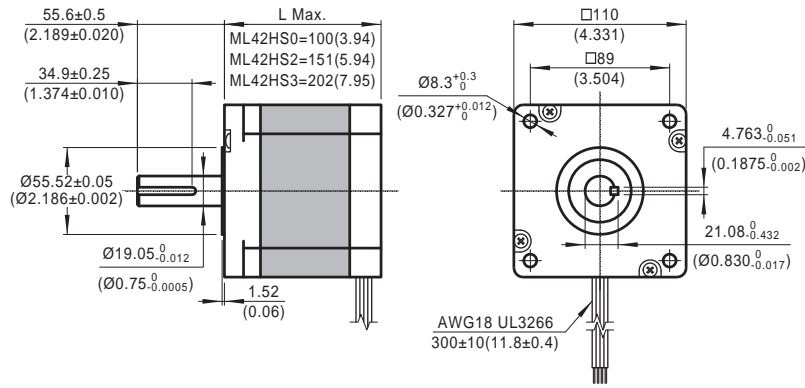
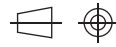

ML42HS0

ML42HS2

ML42HS3

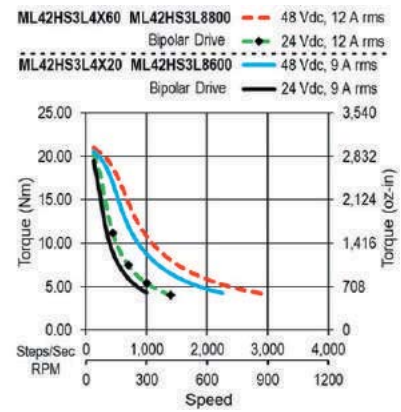
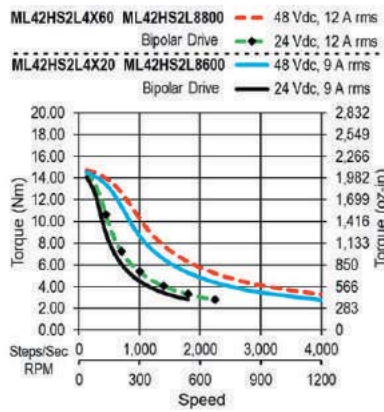
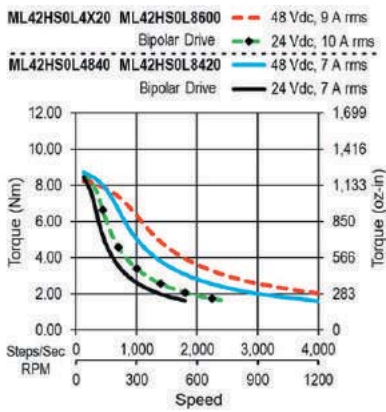
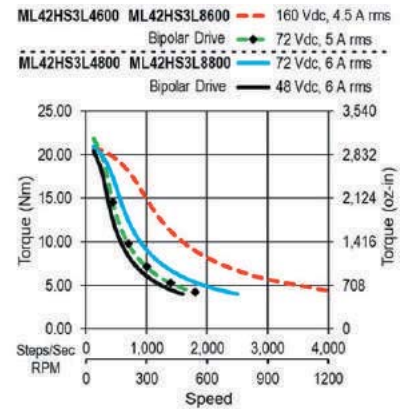
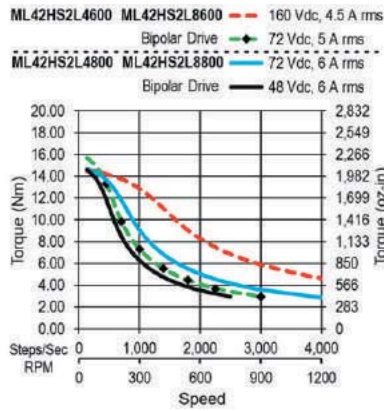
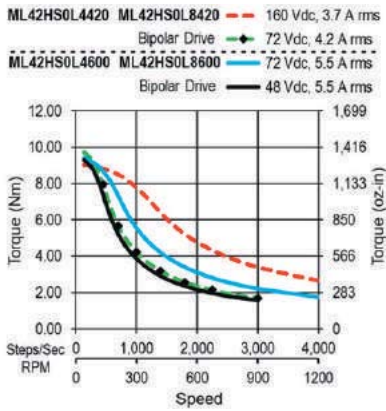
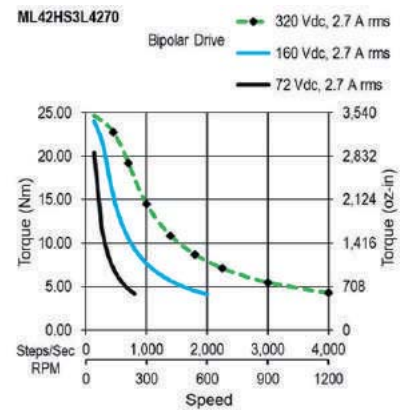
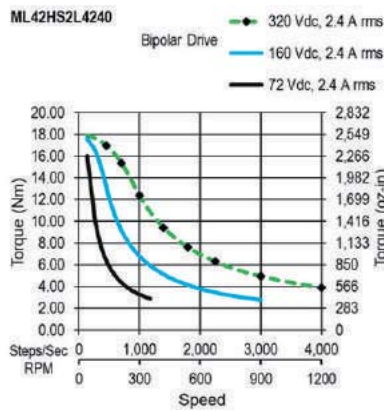
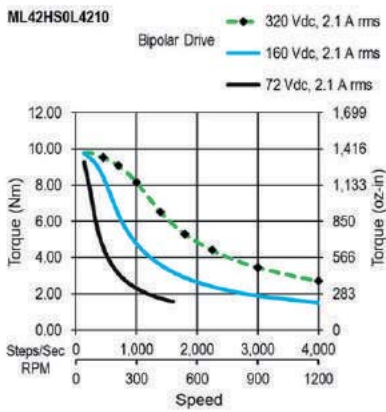

17HC Series: 1.2° - Size 17, 3 Phase Encapsulated



- Phases 3
- Steps / Revolution 300
- Step Accuracy ±5%
- Shaft Load (20,000 Hours at 1000 RPM)
 - Axial 25 N (5.6 Lbs.) Push
65 N (15 Lbs.) Pull
 - Radial 29 N (6.5 Lbs.) At Flat Center
- IP Rating 40
- Approvals RoHS
- Operating Temp. -20°C to +50°C
- Insulation Class B, 130°C
- Insulation Resistance 100 MegOhms

17HC – 3 Phase

Length	Model Number	Connect	Rated Current	Holding Torque		Winding Ohms mH		Detent Torque		Rotor Inertia		Motor Weight	
	Single Shaft	P=Side Plug L=Leads	Amps (mounted)	Nm Typ.	oz-in TYP.	@20 C	Typ.	mNm	oz-in	g cm ²	oz-in ²	kg	Lbs
34 mm (1.34 in.)	^ 17HC2005N	P	0.8	0.36	51	10.6	14.5						
	^ 17HC2006N	P	1.5	0.36	51	3.5	4.8	14	2	57	0.31	0.245	0.54
	^ 17HC2002N	P	2.3	0.36	51	1.67	1.99						
43 mm (1.69 in.)	^ 17HC6003N	P	0.82	0.46	65	13.8	21						
	^ 17HC6004N	P	1.5	0.46	65	4.4	6.5	25	3.5	82	0.45	0.35	0.77
	^ 17HC6005N	P	2.3	0.46	65	1.88	2.7						

^ Preferred model

Dimensions: mm (in)

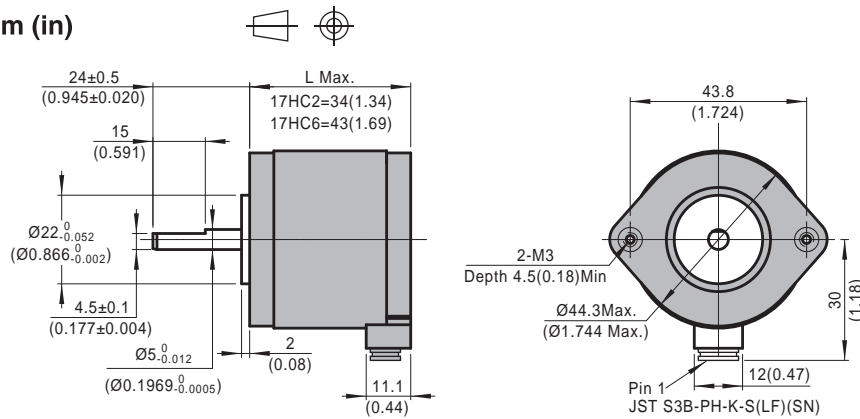

Mating Connector With Leads (order separately)

Dimensions: mm (in)

3 Lead Part Number 4634 1402 04496

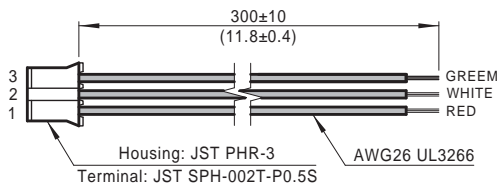

MOONS' 17HC, 3 phase step motors, offer numerous advantages:

- More Torque
- Low Noise
- Low Vibration
- Low Resonance
- Encapsulated Construction

Molded Stator

Encapsulated winding >>>> Runs cooler – Longer life
 Better sealing >>>> Longer life
 Reduced vibration >>>> Smoother moves – Quieter

Large Ball Bearings

Large shaft loads >>>> Fewer design restrictions
 Long Life >>>> Less down time

High Winding Fill

Larger wire size >>>> More torque
 Uses less energy >>>> Longer battery life



17HC2

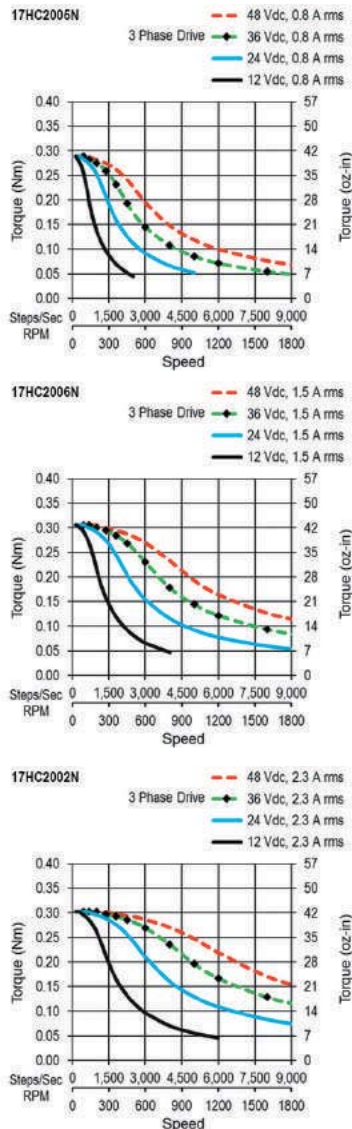

17HC6

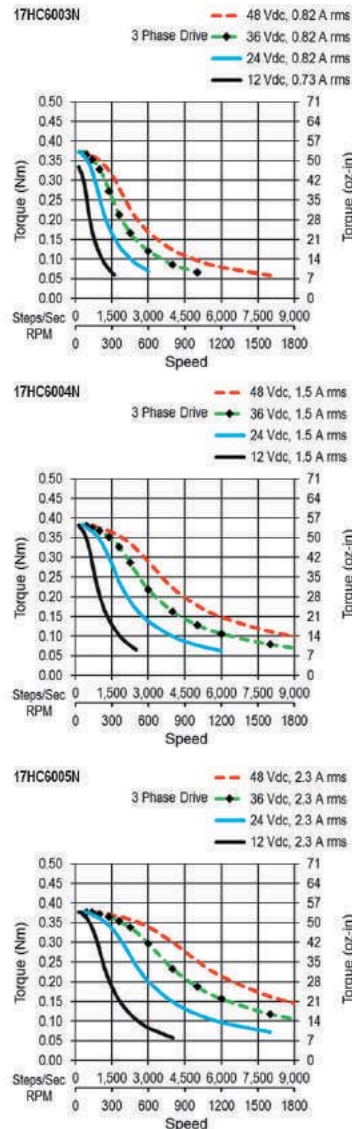

ML24HC – 3 Phase

Length	Model Number	Connect	Rated Current	Holding Torque		Winding Ohms mH		Detent Torque		Rotor Inertia		Motor Weight	
	Single Shaft	P=Side Plug L=Leads	Amps (mounted)	Nm Typ.	oz-in TYP.	@20 C	Typ.	mNm	oz-in	g cm ²	oz-in ²	kg	Lbs
45.5 mm (1.79 in.)	^ ML24HC4P3150	P	1.5	0.72	100	4.8	7.9						
	^ ML24HC4P3230	P	2.3	0.72	100	2.1	3.4	28	4	159	0.87	0.65	1.4
	^ ML24HC4L3410	L	4.1	0.72	100	0.67	1.06						
55.5 mm (2.19 in.) 1 Stack	^ ML24HC8P3150	P	1.5	0.97	140	6	15.1						
	^ ML24HC8P3220	P	2.2	0.97	140	2.7	6.9	45	6.4	221	1.2	0.85	1.9
	^ ML24HC8L3350	L	3.5	0.97	140	1.09	2.7						
	^ ML24HC8L3550	L	5.5	0.97	140	0.52	1.1						
77.5 mm (3.05 in.) 2 Stack	^ ML24HCAP3150	P	1.5	1.60	230	7.7	19.6						
	^ ML24HCAP3220	P	2.2	1.60	230	3.9	9.3	75	11	391	2.1	1.35	3
	^ ML24HCAL3340	L	3.4	1.60	230	1.57	3.7						
	^ ML24HCAL3550	L	5.5	1.60	230	0.64	1.44						

^ Preferred model

PL24HC - PowerPlus – 3 Phase

Length	Model Number	Connect	Rated Current	Holding Torque		Winding Ohms mH		Detent Torque		Rotor Inertia		Motor Weight	
	Single Shaft	P=Side Plug L=Leads	Amps (mounted)	Nm Typ.	oz-in TYP.	@20 C	Typ.	mNm	oz-in	g cm ²	oz-in ²	kg	Lbs
45.5 mm (1.79 in.)	^ PL24HC4P3150	P	1.5	0.87	120	4.8	7						
	^ PL24HC4P3230	P	2.3	0.87	120	2.1	3	55	7.8	159	0.87	0.73	1.6
	^ PL24HC4L3410	L	4.1	0.87	120	0.67	0.94						
55.5 mm (2.19 in.) 1 Stack	^ PL24HC8P3150	P	1.5	1.40	200	6	12.2						
	^ PL24HC8P3220	P	2.2	1.40	200	2.7	5.5	90	13	221	1.2	0.93	2.1
	^ PL24HC8L3350	L	3.5	1.40	200	1.09	2.2						
	^ PL24HC8L3550	L	5.5	1.40	200	0.52	0.88						
77.5 mm (3.05 in.) 2 Stack	^ PL24HCAP3150	P	1.5	2.10	300	7.7	15.7						
	^ PL24HCAP3220	P	2.2	2.10	300	3.9	7.4	150	21	391	2.1	1.45	3.2
	^ PL24HCAL3340	L	3.4	2.10	300	1.57	3						
	^ PL24HCAL3550	L	5.5	2.10	300	0.64	1.15						

^ Preferred model

Mating Connector With Leads (order separately)

Dimensions: mm (in)

3 Lead Part Number 4634 1402 04485

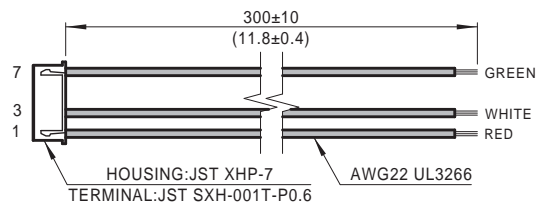

ML24HC4

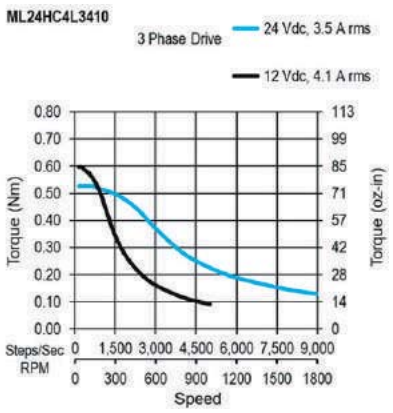
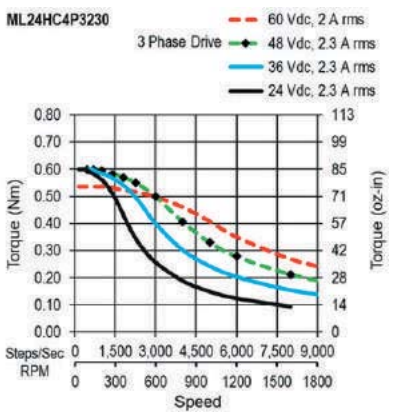
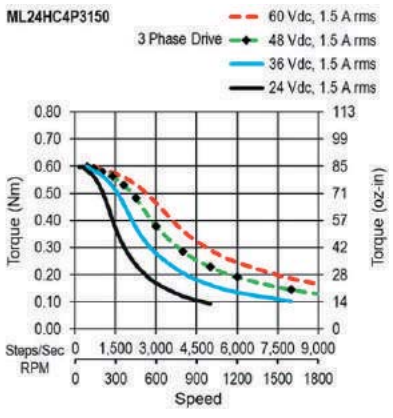

ML24HC8

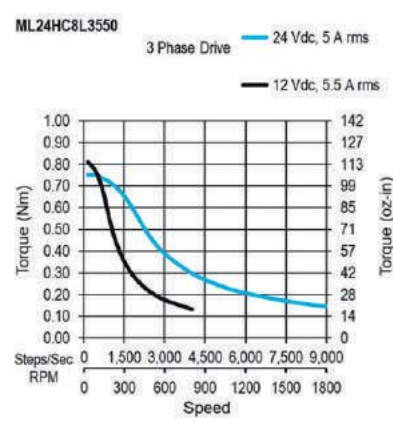
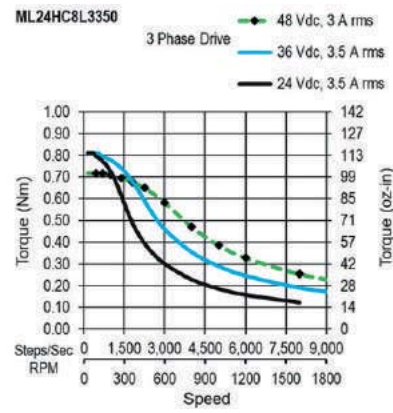
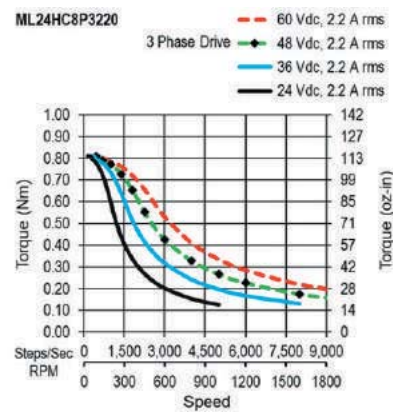
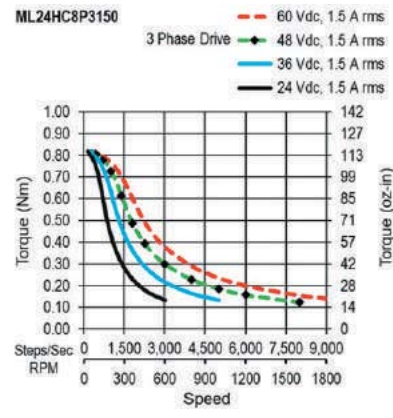

ML24HCA

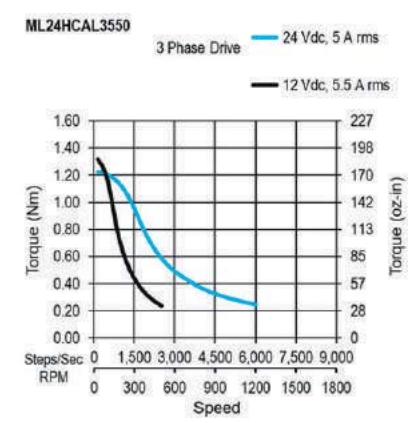
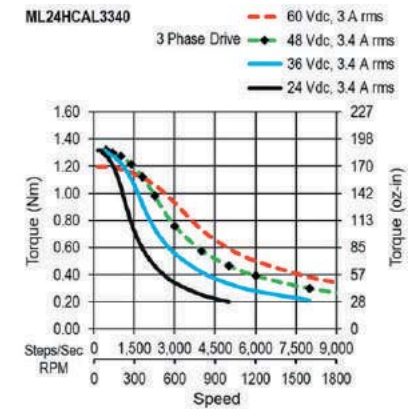
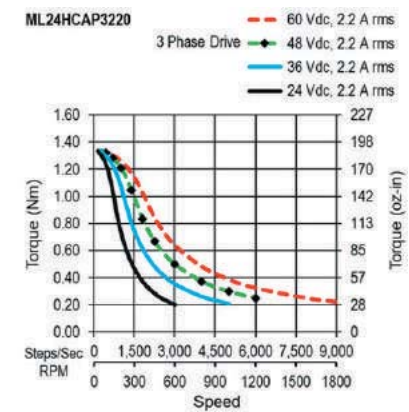
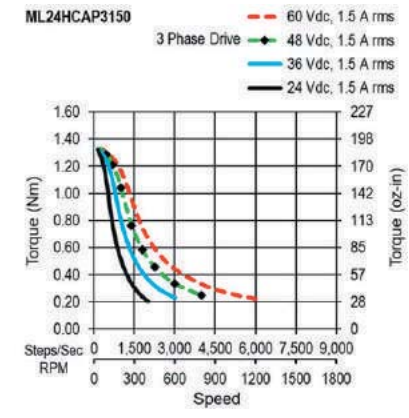

PowerPlus PL24HC4

PowerPlus PL24HC8

PowerPlus PL24HCA

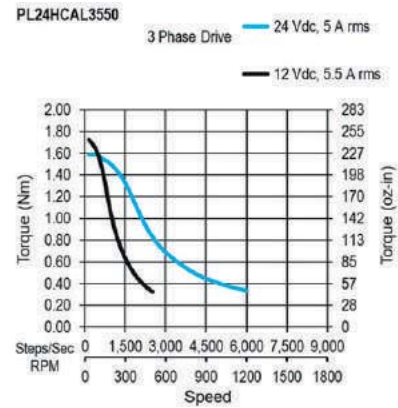
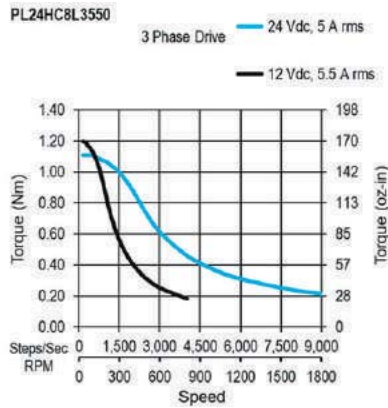
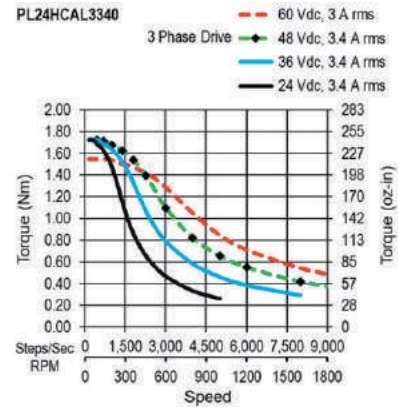
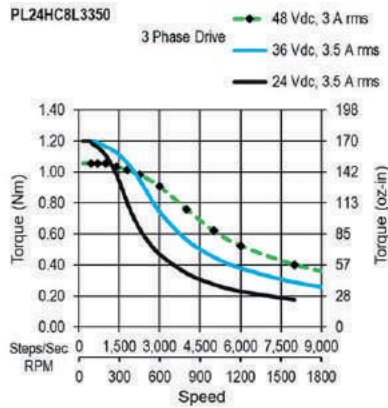
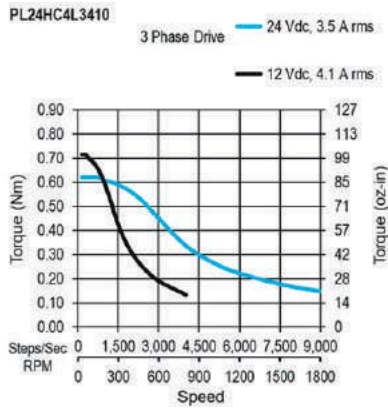
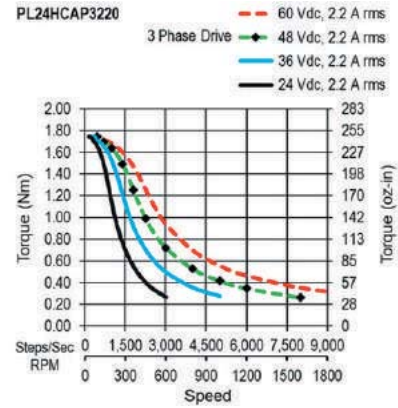
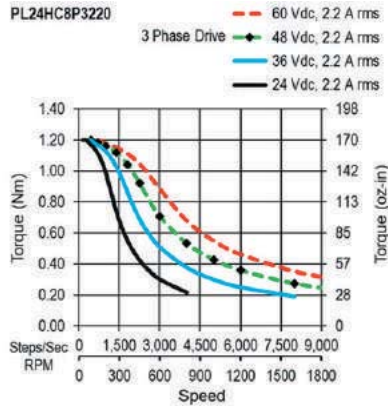
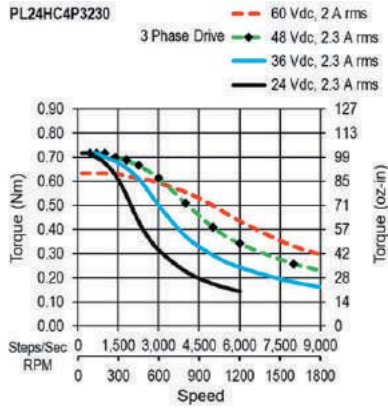
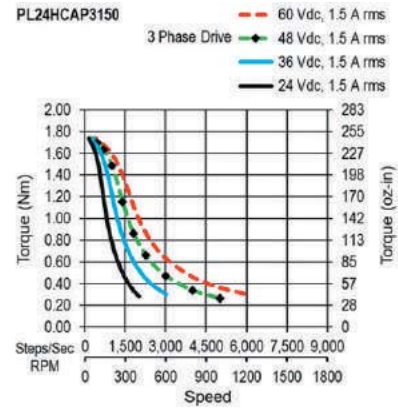
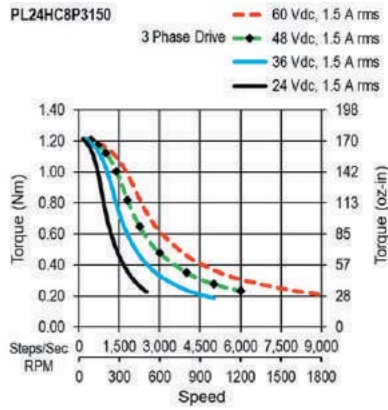
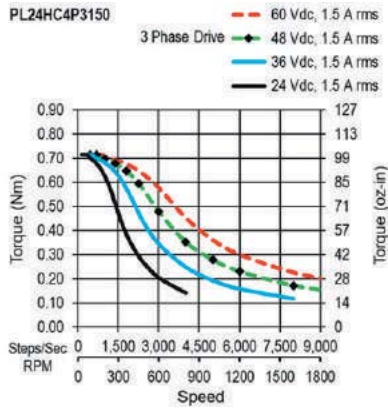

34HC Series: 1.2° - Size 34, 3 Phase



- Phases 3
- Steps / Revolution 300
- Step Accuracy ±5%
- Shaft Load (20,000 Hours at 1000 RPM)
 - Axial 65 N (15 Lbs.) Push
155 N (35 Lbs.) Pull
 - Radial 220 N (50 Lbs.) At Flat Center
- IP Rating 40
- Approvals RoHS
- Operating Temp. -20°C to +50°C
- Insulation Class B, 130°C
- Insulation Resistance 100 MegOhms

34HC - 3 Phase

Length	Model Number	Connect	Rated Current	Holding Torque		Winding		Detent Torque		Rotor Inertia		Motor Weight	
				Amps (mounted)	Nm Typ. oz-in TYP.	@20 C	mH Typ.	mNm	oz-in	g cm ²	oz-in ²	kg	Lbs
67.5 mm (2.66 in.) 1 Stack	^ 34HC0309	L	2	2.80	400	5	19.1						
	^ 34HC0310	L	3	2.80	400	2.3	8.4	100	14	1100	6	1.6	3.5
	^ 34HC0305	L	5.8	2.70	380	0.54	1.95						
97 mm (3.82 in.) 2 Stack	^ 34HC1308	L	2	5.40	760	6	28						
	^ 34HC1309	L	3	5.30	750	2.5	12	230	33	1850	10	2.7	6
	^ 34HC1305	L	5.8	5.00	710	0.62	2.7						
126.5 mm (4.98 in.) 3 Stack	^ 34HC2310	L	2	6.70	950	6.8	36						
	^ 34HC2311	L	3	6.80	960	3.3	16.8	350	50	2750	15	3.8	8.4
	^ 34HC2306	L	5.8	6.80	960	0.88	4.5						

^ Preferred model

Dimensions: mm (in)

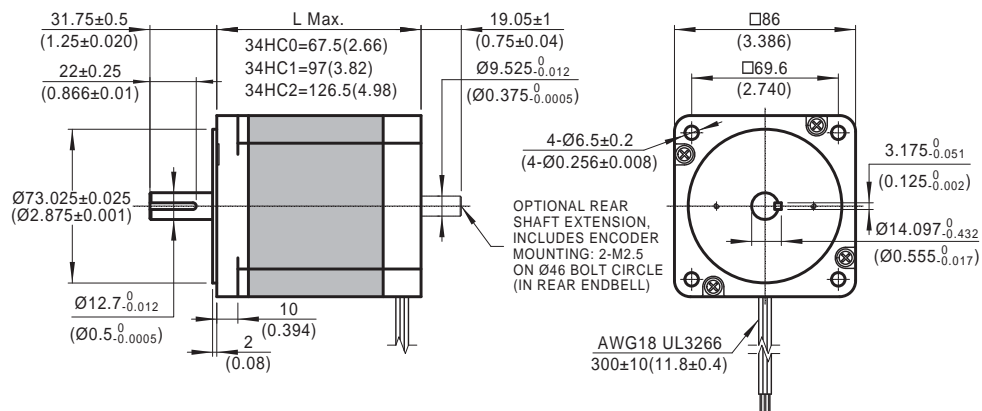
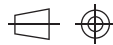

34HC0

34HC1

34HC2

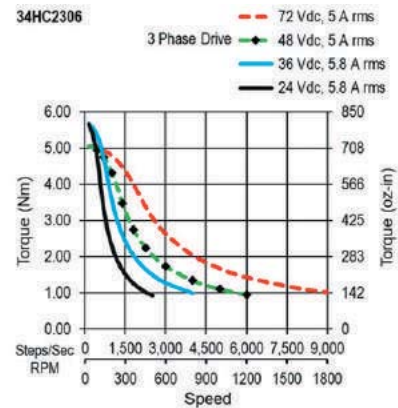
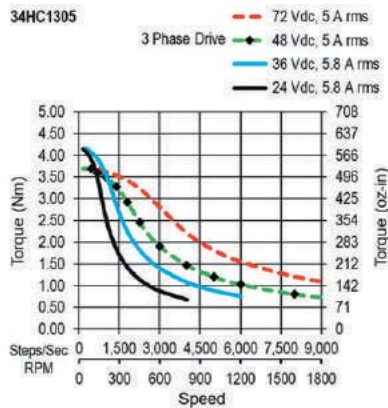
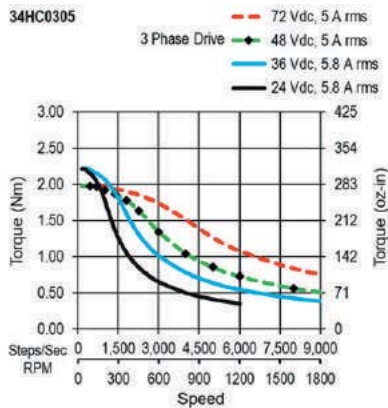
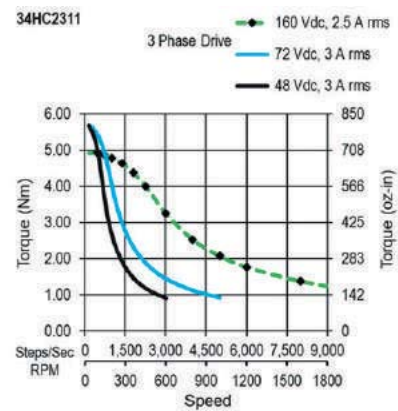
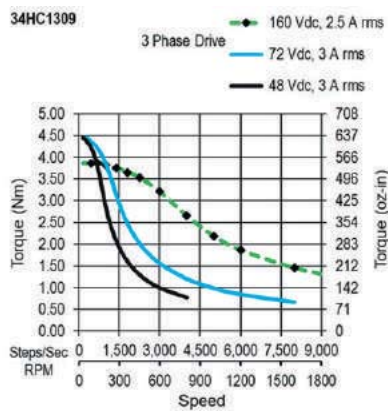
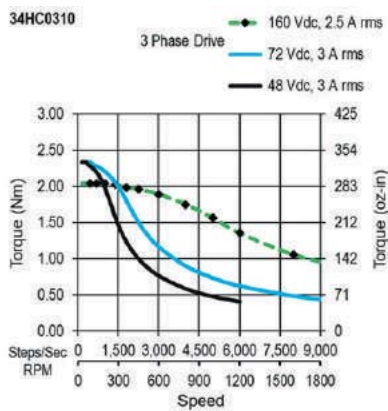
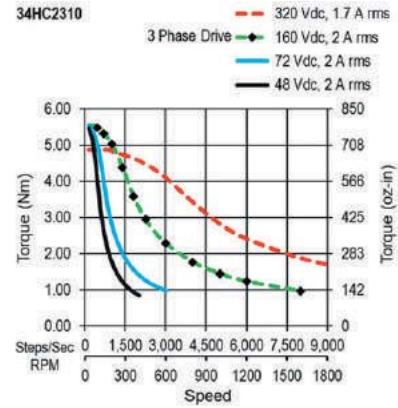
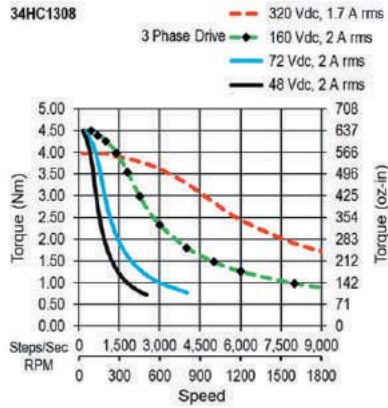
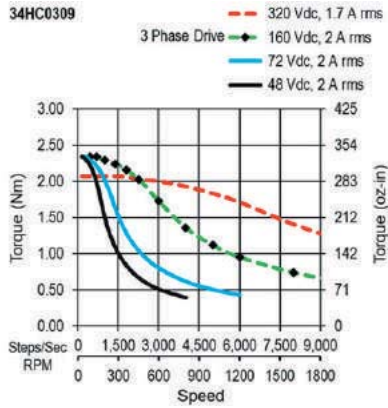

Step Motor Basics – Applications

- **Applications**

MOONS' stepping motors are widely used to create the motion needed in many types of equipment.

Examples include:

- office automation: printers, scanners, copy machines
- stage lighting: pointing, focus, color changes, spot size, special effects
- banking: check processing, credit card manufacturing, money scanners & counters
- medical: body scanning, blood analyzers, chemical analysis
- industrial: textile, packaging, robotics, conveyers, assembly, labeling
- telecommunication: phase shift, Tuning, mobile antenna positioning
- security: camera movement
- automotive: fuel metering, steering control

- **What Is A Stepping Motor**

Stepping Motors provide precise position and speed control, without the need for feedback devices to sense position. The operation of step motors is controlled through electrical pulses that the drive converts to current flowing through the windings of the motor. As the current is switched the motor rotates in precise steps of a fixed angle. The motor and drive constitutes a low cost control system that is precise and simple to construct.

- **Performance Features of MOONS' Stepping Motors**

- **Accurate Position Control**

The number of control pulses defines the motor shaft position. Position error is very small (less than 1/10th of a degree), and non cumulative.

- **Precise Motor Speed**

Step motor running speed, is exactly determined by the frequency of the control pulses. Because the speed is very precise and easy to control, step motors are often used where coordinated motion control is needed.

- **Forward & Reverse, Pause and Holding Function**

Motor torque and position control is effective throughout the entire speed range, including zero speed holding torque. The zero speed holding torque locks the shaft at the desired position to hold the load in place.

- **Low Speed Operation**

Step motors produce a large amount of torque, and are easy to control, at low speeds. This often eliminates the need for speed reduction gearboxes, reduces costs and saves space.

- **Long Life**

The brushless design of step motors leads to motors with a very long life. Step motor life is usually determined by the life of the bearings.

Step Motor Basics – Structure & Operation

• Basic Structure

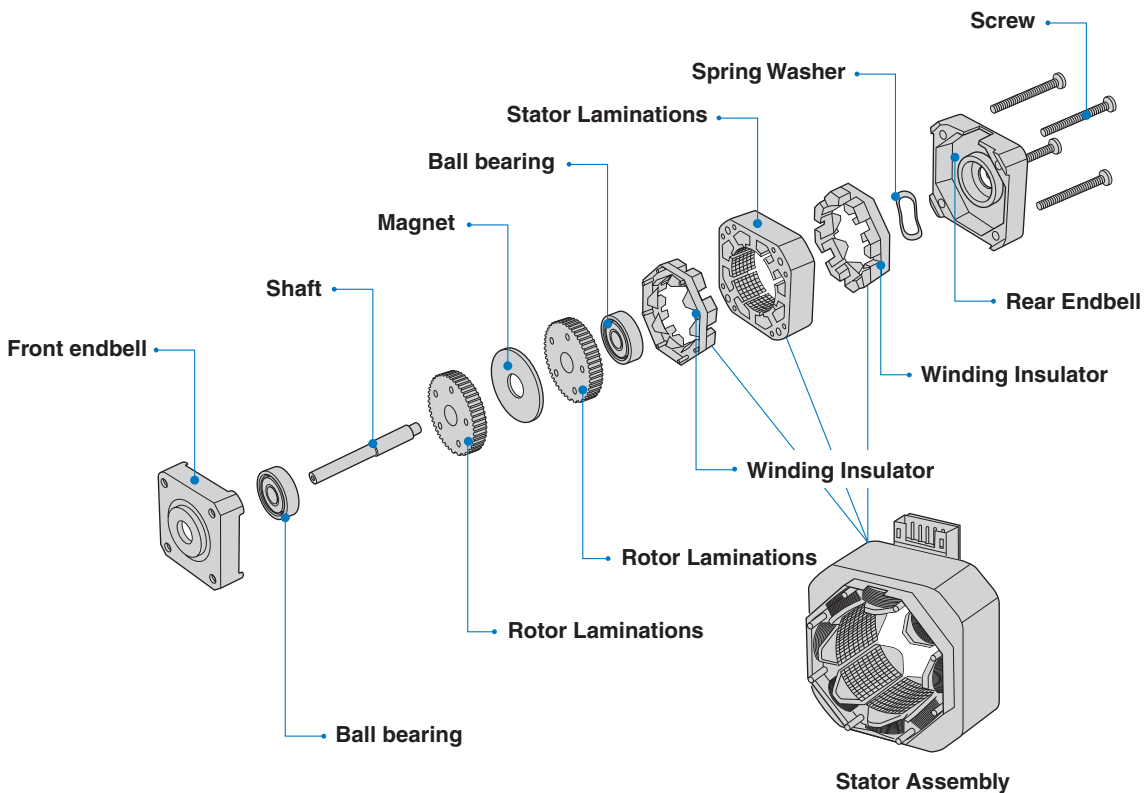

Stator Assembly

• Operating Principles

In response to each individual control pulse and direction signal, the drive applies power to the motor windings to cause the rotor to take a step forward, a step in reverse, or hold in position. For example, in a 1.8 degree two phase step motor: When both phases are energized with DC current, the motor will stop rotating and hold in position. The maximum torque the motor can hold in place with rated DC current, is the rated holding torque. If the current in one phase is reversed, the motor will move 1 step (1.8 degrees) in a known direction.

If the current in the other phase had been reversed, the motor would move 1 step (1.8 degrees) in the other direction. As current is reversed in each phase in sequence, the motor continues to step in the desired direction. These steps are very accurate. For a 1.8 degree step motor, there are exactly 200 steps in one revolution.

Two phase stepping motors are furnished with two types of windings: bipolar or unipolar. In a bipolar motor there is one winding on each phase. The motor moves in steps as the current in each winding is reversed. This requires a drive with eight electronic switches. In a unipolar motor there are two windings on each phase. The two windings on each phase are connected in opposite directions. Phase current is reversed by turning on alternate windings on the same phase. This requires a drive with only four electronic switches. Bipolar operation typically provides 40% more holding torque than unipolar, because 100% of the winding is energized in the bipolar arrangement.

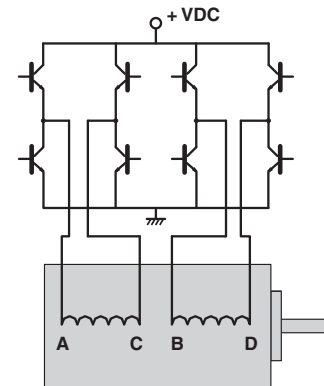

2 phase step motor with bipolar driver

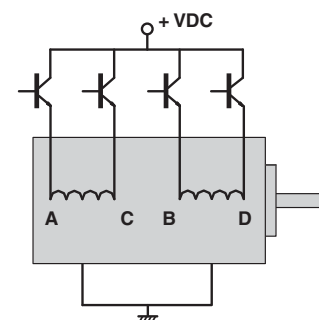

2 phase step motor with unipolar driver

Load Calculations & Tips for Using Step Motors

• Load Calculations

Torque load (Tf)

$$Tf = G * r$$

G: weight

r: radius

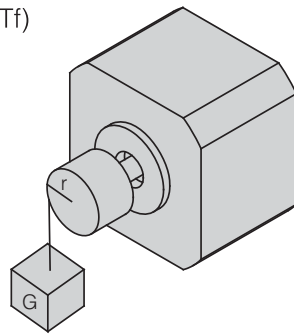

Inertia load (TJ)

$$TJ = J * dw/dt$$

$$J = M * (R1^2 + R2^2) / 2$$

(Kg * cm)

M: mass

R1: outside radius

R2: inside radius

dw/dt: angular acceleration

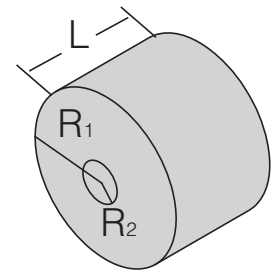

• Speed-Torque Characteristics

The dynamic torque curve is an important aspect of stepping motor's output performance. The followings are some keyword explanations.

A. Working frequency point express the stepping motors rotational speed versus the drive pulse rate.

$$n = q * Hz / (360 * D)$$

n: rev/sec

Hz: the frequency value or the driver pulse rate.

D: the subdividing value of motor driver

q: the step angle of stepping motor

E.g.: 1.8° stepping motor, in the condition of 1/2 subdividing (each step 0.9°) runs at 500Hz its speed is 1.25r/s.

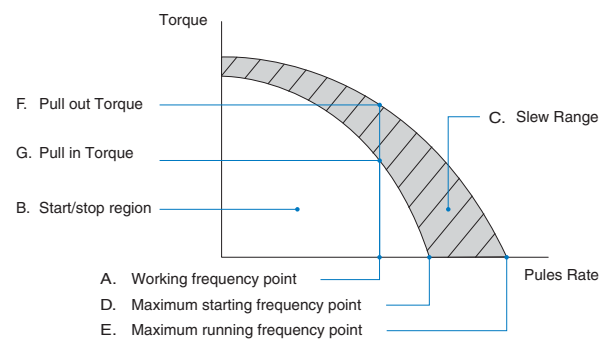

B. Start/Stop region: the region in which a stepping motor can be directly started or stopped.

C. Slew Range: the motor cannot be started directly in this area. It must be started in the start/stop region first and then accelerated to this area. In this area, the motor can not be directly stopped, either. Otherwise this will lead to losing-step. The motor must be decelerated back to the start/stop region before it can be stopped.

D. Maximum starting frequency point at this point, the stepping motor can reach its maximum starting speed under unloaded condition.

E. Maximum running frequency point at this point the stepping motor can reach its maximum running speed under an unloaded condition.

F. Pull-in Torque: the maximum dynamic torque value that a stepping motor can load directly at the particular operating frequency point.

G. Pull-out Torque: the maximum dynamic torque value that a stepping motor can load at the particular operating frequency point when the motor has been started. Because of the inertia of rotation the Pull-Out Torque is always larger than the Pull-In Torque.

Load Calculations & Tips for Using Step Motors

• Calculate the Acceleration Torque

The torque needed to accelerate the system inertia is often larger than the friction torque of the load. This limits how quickly the load can be accelerated.

As shown by the following graph: the dynamic torque performance of a stepping motor is constant at low speeds. But at higher speeds, the torque drops as speed increases (influenced by the motor inductance and drive voltage).

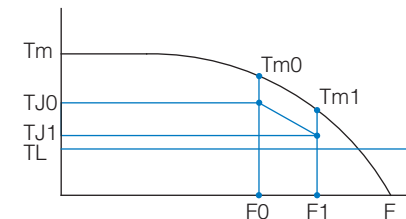
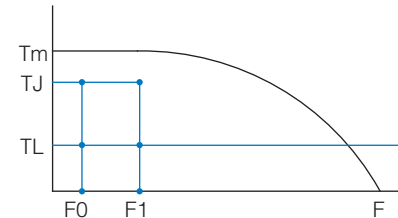
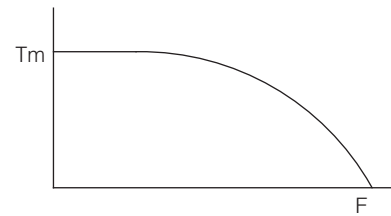

A. Accelerated Motion of Straight Line

Motor's load value is known as T_L , it has to be accelerated from F_0 to F_1 in the shortest time (t_r), what is the value of t_r ?

(1). Generally $T_J = 70\%T_m$

(2). $t_r = 1.8 * 10^{-5} * J * q * (F_1 - F_0) / (T_J - T_L)$

(3). $F(t) = (F_1 - F_0) * t / t_r + F_0, 0 < t < t_r$

B. Exponential Acceleration

(1). Generally

$T_{J0} = 70\%T_{m0}$,

$T_{J1} = 70\%T_{m1}$,

$T_L = 60\%T_{m1}$

(2). $t_r = F_4 * \ln [(T_{J0} - T_L) / (T_{J1} - T_L)]$

(3). $F(t) = F_2 * [1 - e^{-(t/F_4)}] + F_0, 0 < t < t_r$

$F_2 = (T_L - T_{J0}) * (F_1 - F_0) / (T_{J1} - T_{J0})$

$F_4 = 1.8 * 10^{-5} * J * q * F_2 / (T_{J0} - T_L)$

Note: J is the rotational inertia of motor rotor plus the load, q is the angle of each step, it equals the step angle of stepping motor when motor runs in full step.

• Reduction of Vibration and Noise

In a non-loading condition, stepping motors may appear to have vibration or even lose steps when the motor is running at or close to resonant frequency. Solutions for these conditions include:

A. Have the motor operate outside of this speed range.

B. Micro-step is used for increasing a motor's step resolution. By adopting the micro-step driving method, you can divide one step into multiple steps thereby reducing the vibration. This is accomplished by controlling the motor's phase current ratio. Micro-step does not increase step accuracy. However it will allow a motor to run more smoothly and with less noise. When the motor runs in half step mode the motor torque will be 15% less than running in full step mode. If the motor is controlled by sine wave current the motor torque will be reduced by 30% if using the same peak current.

C. Use 0.9° 2 phase step motor, or a three phase step motor.

Step Sequence & Schematic Diagrams

• 2 Phase Motors

Bipolar, Full Step

STEP	Phase 1		Phase 2	
	A	C	B	D
1	+	-	+	-
2	-	+	+	-
3	-	+	-	+
4	+	-	-	+

CW ↓ ↑ CCW

CW & CCW rotation when seen from flange side of the motor.

Unipolar, Full step

STEP	Phase 1			Phase 2		
	A	O	C	B	M	D
1	-	+		-	+	
2		+	-	-	+	
3		+	-		+	-
4	-	+			+	-

CW ↓ ↑ CCW

CW & CCW rotation when seen from flange side of the motor.

• 4 Lead (bipolar)

Lead Color	Connector Pin #		Motor Size	Motor Size	Motor
	Motor Size	Motor Size			
BLK	1	1	8, 11, 17	14, 16	A
GRN	3	5			C
RED	4	7			B
BLU	6	11			D

• 6 Lead (unipolar)

Lead Color	Connector Pin #		Motor Size	Motor Size	Motor
	Motor Size	Motor Size			
BLK	1	1	8, 11, 17	14, 16	A
YEL	2	3			O
GRN	3	5			C
RED	4	7			B
WHT	5	9			M
BLU	6	11			D

• 8 Lead

8 Lead Connection Options

Bipolar Series	Bipolar Parallel	Unipolar
A	A	A
C	C	O
B	B	B
D	D	M
		D

8 lead Motors

Lead Color	Connector Pin #	Motor
BLK	3	A
YEL	7	A̅
ORG	4	C̅
GRN	8	C
RED	6	B
WHT	2	B̅
BRN	5	D̅
BLU	1	D

• 3 Phase Motors

STEP	Phase		
	A	B	C
1	+	-	
2		-	+
3	-		+
4	-	+	
5		+	-
6	+		-

CW ↓ ↑ CCW

CW & CCW rotation when seen from flange side of the motor.

	Connector Pin #		Lead Color
	Size 17	Size 23	
A	1	1	RED
B	2	3	WHT
C	3	7	GRN

Bearing Life & Shaft Loading

Moons' uses high quality bearings optimized for step motors for long life from every motor. To meet the most demanding applications. Most motors can also be provided with larger bearings shafts and custom construction.

These bearing life curves represent the maximum axial and radial loads for 20,000 hours L10 bearing life at various speeds. The shaft radial load limit (and bearing load ratings) are highly dependent on the distance from the mounting face where the load is applied. These curves were calculated with the radial load applied at the distance from the mounting face shown on the curve (usually the center of the flat / keyway).

A common cause for shaft (and bearing) failure, are high radial loads that are created when a pulley is attached to the motor shaft at a large distance from the motor mounting face, and the belt has high tension. To avoid this condition mount pulleys and gears as close to the face of the motor as possible, and avoid over tightening belts. This will dramatically reduce the shaft stress, and increases the life of the bearings.

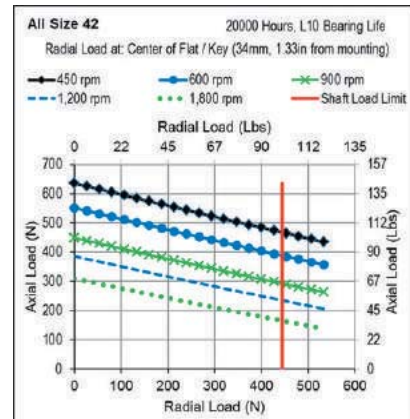
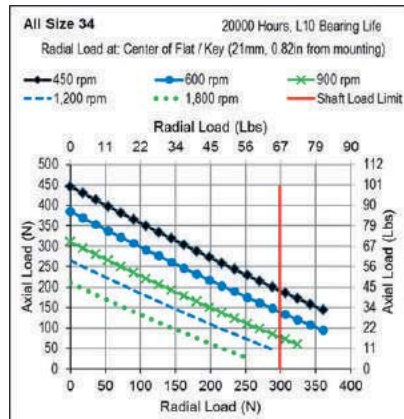
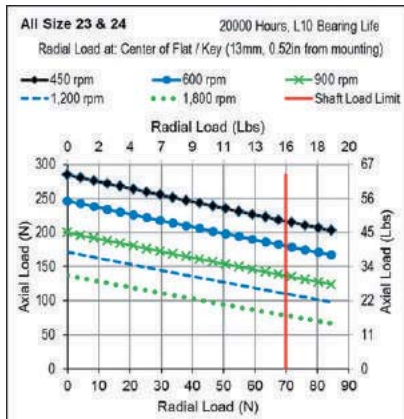
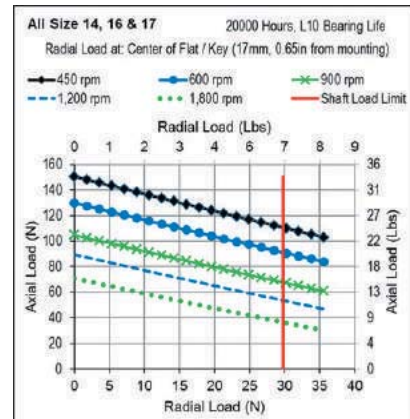
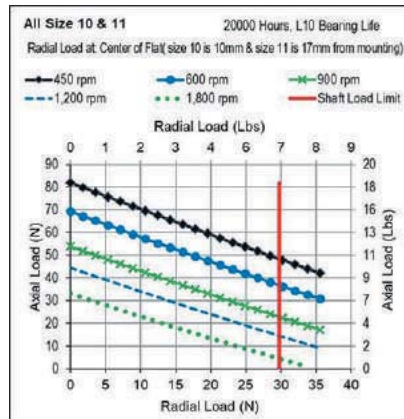
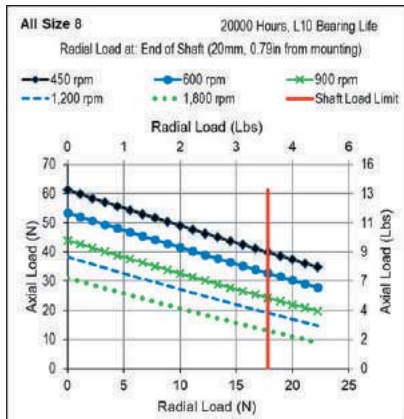
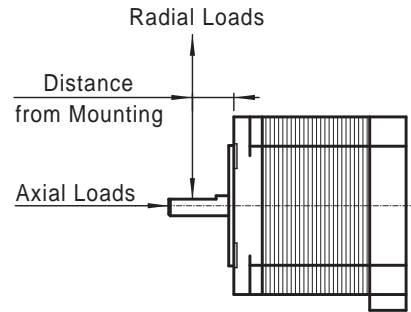

Conversion Factors

• Length

A \ B	mm	cm	m	inch	feet
mm	--	0.1	0.001	0.03937	0.003281
cm	10	--	0.01	0.3937	0.03281
m	1,000	100	--	39.37	3.281
inch	25.4	2.54	0.0254	--	0.08333
feet	304.8	30.48	0.348	12	--

Multiply "A" units
by conversion factor
to obtain "B" units

• Force

A \ B	g	kgf	oz	lb	Newton
g	--	0.001	0.03527	0.002205	0.0098
kgf	1,000	--	35.27	22.05	9.807
oz	28.35	0.02835	--	0.0625	0.278
lb	453.6	0.4536	16	--	4.448
Newton	102	0.102	3.597	0.2248	--

• Torque

A \ B	Nm	Ncm	mNm	kgm*	kgcm*	gcm*	oz-in	lb-ft	lb-in
Nm	--	100	1,000	0.102	10.2	10,200	141.6	0.7376	8.851
Ncm	0.01	--	10	0.00102	0.102	102	1.416	0.007376	0.08851
mNm	0.001	0.1	--	0.000102	0.0102	10.2	0.1416	0.000738	0.008851
kgm*	9.807	980.7	9807	--	100	100,000	1,389	7.233	86.8
kgcm*	0.09807	9.807	98.07	0.01	--	1,000	13.89	0.07233	0.868
gcm*	9.81E-05	0.009807	0.09807	0.00001	0.001	--	0.01389	7.23E-05	0.000868
oz-in	0.007062	0.7062	7.062	0.00072	0.07201	72.01	--	0.00521	0.0625
lb-ft	1.356	135.6	135.6	0.1383	13.83	13,830	192	--	12
lb-in	0.113	11.3	113	0.01152	1.152	1,152	16	0.0833	--

• Inertia

A \ B	kgm ²	kgcm ²	gcm ²	oz-in ²	oz-in-sec ²	lb-in ²	lb-in-sec ²	lb-ft ²	lb-ft-sec ² (slug ft ²)
kgm ²	--	10,000	10,000,000	54,700	142	3,420	8.85	23.7	0.738
kgcm ²	0.0001	--	1,000	5.47	0.0142	0.342	0.000885	0.00237	7.38E-05
gcm ²	1E-07	0.001	--	0.00547	1.42E-05	0.000342	8.85E-07	2.37E-06	7.38E-08
oz-in ²	1.83E-05	0.1829	183	--	0.00259	0.0625	0.000162	0.000434	1.35E-05
oz-in-sec ²	0.00706	70.62	70,600	386	--	24.1	0.0625	0.168	0.00521
lb-in ²	0.000293	2.926	2,930	16	0.0414	--	0.00259	0.00694	0.000216
lb-in-sec ²	0.113	1,130	1,130,000	6,180	1.6	386	--	2.68	0.0833
lb-ft ²	0.0421	421.4	421,000	2,300	5.97	144	0.373	--	0.318
lb-ft-sec ² (slug ft ²)	1.36	13,600	13,600,000	74,100	192	4,630	12	32.2	--

■ MOONS' Headquarter

168 Mingjia Road, Minhang District, Shanghai 201107,
P.R. China

Tel: +86 (0)21 52634688

Fax: +86 (0)21 52634098

■ MOONS' International Trading Company

4/F, Building 30, 69 Guiqing Road, Cao He Jin Hi-Tech
Park, Shanghai 200233, P.R. China

Tel: +86 (0)21 64952755

Fax: +86 (0)21 64951993

■ Domestic Sales Offices

Shenzhen

Room 2209, 22/F, Kerry Center, 2008 Renminnan Road,
Luohu District, Shenzhen 518001, P.R. China

Tel: +86 (0)755 25472080

Fax: +86 (0)755 25472081

Beijing

Room 1206, Jing Liang Mansion, No.16 Middle Road of East
3rd Ring, Chaoyang District, Beijing 100022, P.R. China

Tel: +86 (0)10 87661889

Fax: +86 (0)10 87661880

Nanjing

Room 1101-1102, Building 2, New Town Development
Center, No.126 Tianyuan Road, Moling Street,
Jiangning District, Nanjing 211106, P.R. China

Tel: +86 (0)25 52785841

Fax: +86 (0)25 52785485

Qingdao

Room 1012, Zhuoyue Tower, No.16 Fengcheng Road,
Shibei District, Qingdao 26000, P.R. China

Tel: +86 (0)532 80969935

Fax: +86 (0)532 80919938

Wuhan

Room 3001, World Trade Tower, 686 Jiefang Avenue,
Jianghan District, Wuhan 430022, P.R. China

Tel: +86 (0)27 85448742

Fax: +86 (0)27 85448355

Chengdu

Room 1917, Western Tower, 19, 4th Section of South People
Road, Wuhou District, Chengdu 610041, P.R. China

Tel: +86 (0)28 85268102

Fax: +86 (0)28 85268103

Xi'an

Room 1006, Tower D, Wangzuo International City,
1 Tangyan Road, Xi'an 710065, P.R. China

Tel: +86 (0)29 81870400

Fax: +86 (0)29 81870340

Chongqing

Rm. 2108, South yuanzhu Buliding 20, No.18 Fuquan Rd.,
Jiangbei District, Chongqing 400000, P.R. China.

Tel: +86 (0)23 67601782

Fax: +86 (0)23 67085997

Ningbo

Room 309, Tower B, Taifu Plaza, 565 Jiangjia Road,
Jiangdong District, Ningbo, 315040, P.R. China

Tel: +86 (0)574 87052739

Fax: +86 (0)574 87052365

Guangzhou

Room 4006, Tower B, China Shine Plaza, 9 Linhe Xi Road,
Tianhe District, Guangzhou 510610, P.R. China

Tel: +86 (0)20 38010153

Fax: +86 (0)20 38103661

■ North America

MOONS' INDUSTRIES (AMERICA), INC.

Head Office

1113 North Prospect Avenue, Itasca, IL 60143 USA

Tel: +1 630 8335940

Fax: +1 630 8335946

Boston Office

36 Cordage Park Circle, Suite 310

Plymouth, MA 02360 USA

APPLIED MOTION PRODUCTS, INC.

404 Westridge Dr. Watsonville, CA 95076, USA

Tel: +1 831 7616555

LIN ENGINEERING, INC.

16245 Vineyard Blvd., Morgan Hill, CA 95037

Tel: +1 408 9190200

Fax: +1 408 9190201

■ Europe

MOONS' INDUSTRIES EUROPE HEAD QUARTER S.R.L.

Via Torri Bianche 1, 20871 Vimercate (MB), Italy

Tel: +39 039 6260521

E-Mail: info@moonsindustries.eu

AMP & MOONS' AUTOMATION (GERMANY) GMBH

Börsenstraße 14

60313 Frankfurt am Main Germany

Technosoft (Suisse) SA

Avenue des Alpes 20, 2000 Neuchâtel, Switzerland.

Tel: +41 032 732 55 00

Fax: +41 032 732 55 04

■ South-East Asia

MOONS' INDUSTRIES (SOUTH-EAST ASIA) PTE. LTD.

33 Ubi Avenue 3 #08-23 Vertex Singapore 408868

Tel: +65 66341198

Fax: +65 66341138

■ Japan

MOONS' INDUSTRIES JAPAN CO., LTD.

Room 601, 6F, Shin Yokohama Koushin Building,
2-12-1, Shin-Yokohama, Kohoku-ku, Yokohama,
Kanagawa, 222-0033, Japan

Tel: +81 (0)45 4755788

Fax: +81 (0)45 4755787



<https://www.moonsindustries.eu>

E-mail: info@moonsindustries.eu

MOONS'
moving in better ways

- All specifications and technical parameters of the products provided in this catalog are for reference only, and are subject to change without notice. For details, please contact our sales team.