

Enclosed Disconnect switches



Enclosed disconnect switches

16A – 3150A Non-fusible

30A – 800A Fusible



SafeLine enclosed disconnect switches are designed to meet customer requirements in terms of safety, ease of installation, space savings and operational convenience. They are available in a wide range of amperage ratings, are UL approved and NEMA rated to satisfy rugged industrial environments.

**Disconnect
switches**
Non-fusible
Enclosed

eOT UL508 Enclosed switches

The eOT series of enclosed manual motor controllers are rotary operated, 3 pole, 600V Hp rated switches, housed in thermoplastic/polycarbonate enclosures suitable for wet and corrosive environments.



EOT16U3P3-S



EOT16U3P4-P

NEMA 3R/12

| Handle type | Handle color | Amp rating | Auxiliary contacts | Catalog number | List price |
|-------------|--------------|------------|--------------------|----------------|------------|
| Selector | Black | 16 | -- | EOT16U3P3-S | \$ 250 |
| Selector | Black | 40 | -- | EOT32U3P3-S | 300 |
| Selector | Black | 60 | -- | EOT45U3P3-S | 325 |
| Pistol | Black | 80 | -- | EOT63U3P3-P | 355 |
| Selector | Black | 16 | 1 NO | EOT16U3P3-1S | 305 |
| Selector | Black | 40 | 1 NO | EOT32U3P3-1S | 370 |
| Selector | Black | 60 | 1 NO | EOT45U3P3-1S | 405 |
| Pistol | Black | 80 | 1 NO | EOT63U3P3-1P | 435 |
| Selector | Red/Yellow | 16 | -- | EOT16U3P3-S1 | 250 |
| Selector | Red/Yellow | 40 | -- | EOT32U3P3-S1 | 300 |
| Selector | Red/Yellow | 60 | -- | EOT45U3P3-S1 | 325 |
| Pistol | Red/Yellow | 80 | -- | EOT63U3P3-P1 | 385 |
| Selector | Red/Yellow | 16 | 1 NO | EOT16U3P3-1S1 | 305 |
| Selector | Red/Yellow | 40 | 1 NO | EOT32U3P3-1S1 | 370 |
| Selector | Red/Yellow | 60 | 1 NO | EOT45U3P3-1S1 | 405 |
| Pistol | Red/Yellow | 80 | 1 NO | EOT63U3P3-1P1 | 435 |

NEMA 4/4X

| | | | | | |
|--------|------------|----|------|---------------|--------|
| Pistol | Black | 16 | -- | EOT16U3P4-P | \$ 270 |
| Pistol | Black | 40 | -- | EOT32U3P4-P | 325 |
| Pistol | Black | 60 | -- | EOT45U3P4-P | 365 |
| Pistol | Black | 80 | -- | EOT63U3P4-P | 385 |
| Pistol | Black | 16 | 1 NO | EOT16U3P4-1P | 335 |
| Pistol | Black | 40 | 1 NO | EOT32U3P4-1P | 400 |
| Pistol | Black | 60 | 1 NO | EOT45U3P4-1P | 445 |
| Pistol | Black | 80 | 1 NO | EOT63U3P4-1P | 475 |
| Pistol | Red/Yellow | 16 | -- | EOT16U3P4-P1 | 270 |
| Pistol | Red/Yellow | 40 | -- | EOT32U3P4-P1 | 325 |
| Pistol | Red/Yellow | 60 | -- | EOT45U3P4-P1 | 365 |
| Pistol | Red/Yellow | 80 | -- | EOT63U3P4-P1 | 385 |
| Pistol | Red/Yellow | 16 | 1 NO | EOT16U3P4-1P1 | 335 |
| Pistol | Red/Yellow | 40 | 1 NO | EOT32U3P4-1P1 | 400 |
| Pistol | Red/Yellow | 60 | 1 NO | EOT45U3P4-1P1 | 445 |
| Pistol | Red/Yellow | 80 | 1 NO | EOT63U3P4-1P1 | 475 |

Accessories for eOT16 – eOT63

| Description | For use on | AC thermal amp rating | AC rated voltage | Catalog number | List price |
|---|---------------|-----------------------|------------------|----------------|------------|
| Auxiliary contacts ② | | | | | |
| NO, mounts on right side of the switch only | eOT16 - 63 | 10 | 600 | OA1G10 | \$ 20 |
| NC, mounts on left side of the switch only | | 10 | 600 | OA1G01 | 20 |
| 4th pole ③ | | | | | |
| 4th pole | eOT16 & eOT32 | 40 | 600 | OTPS40FPN1 | 36 |
| 4th pole, late-break / early-make function | eOT32 | 40 | 600 | OTPL40FP | 36 |
| 4th pole | eOT45 & eOT63 | 80 | 600 | OTPS80FP | 44 |
| 4th pole, late-break / early-make function | eOT63 | 80 | 600 | OTPL80FP | 44 |

① Due to torque requirements, the eOT63 is equipped with a pistol handle for both 3X/12 & 4/4X versions.

② Maximum number of auxiliary contacts: 2NO + 1NC.

③ Only one additional pole per switch.

eOT Enclosed switches

Approximate dimensions

eOT16_ - eOT45U

Disconnect
switches
Non-fusible
Enclosed

eOT16_, eOT32_ (enclosure size 1)

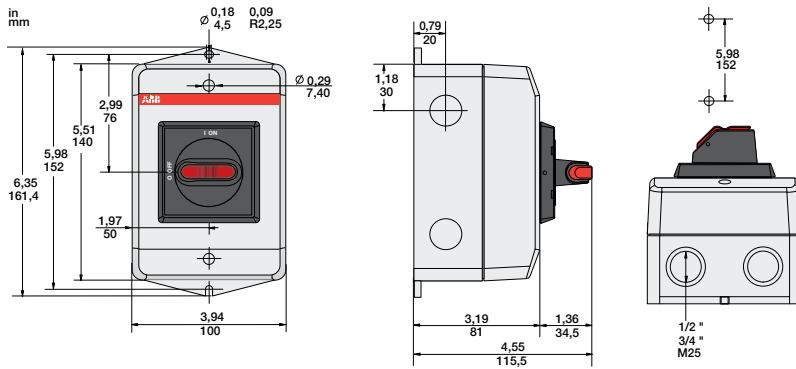

eOT45U_ (enclosure size 2 with selector handle)

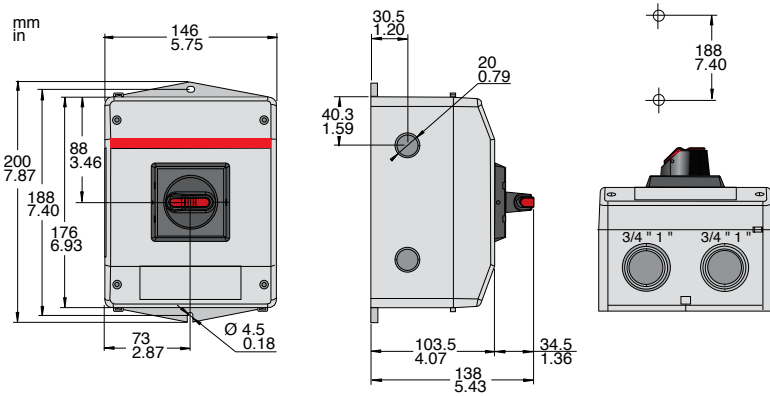

eOT45U_ (enclosure size 2 with pistol grip handle)

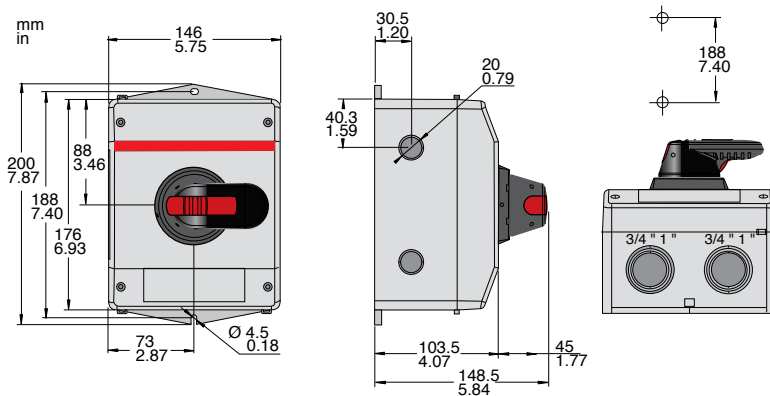

Disconnect
switches
Non-fusible
Enclosed

eOT Enclosed manual motor controllers

Approximate dimensions
eOT63_

eOT63_ (enclosure size 3 with pistol grip handle)

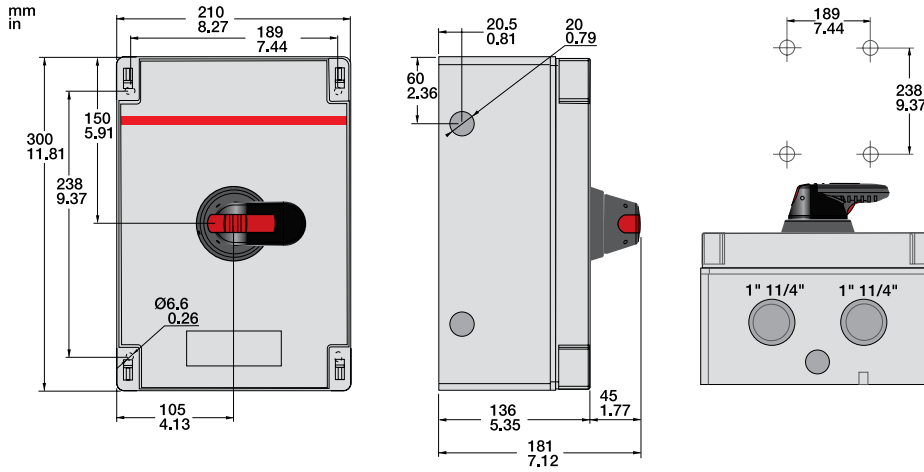

General information

Non-fusible, fusible & lockable

Disconnect
switches
Non-fusible
Enclosed

Non-Fusible

UL Listed to UL 508 and UL 98.
CSA approved
IEC rated
CE marked

Snap on accessories include additional poles, auxiliary contacts, etc.

Enclosures available in plastic, metal, or stainless steel in NEMA 1, 3R, 12, 4X, 7 & 9 environmental categories



Modern appearance

Quick make, quick brake mechanism

Heavy duty disconnect, 600VAC

Extremely compact size

Finger-proof construction. No hazardous exposed parts

3/4/6/8 pole constructions; transfer switches and by-pass switches available

Fusible

UL Listed to UL 98 standards.
CSA approved
IEC rated
CE marked

Snap on accessories include fuse monitors, auxiliary contacts, etc.

Enclosures available in plastic, metal, or stainless steel in NEMA 1, 3R, 12, 4X, 7 & 9 environmental categories

Fuse carriers available for US standards, BS, DIN, NFC standard and for various high speed fuse patterns



Modern appearance

Quick make, quick brake mechanism

Heavy duty disconnect, 600VAC, 200kA, I_{SC}

Extreme compact size as fuse carriers are decked above contacts

Double contacts enabling feed from any direction and preventing back feed

Finger-proof construction. No hazardous exposed parts

3/4/6/8 pole constructions; transfer switches and by-pass switches available

Lockable

Clear position indications:
I-ON
O-OFF

Door interlocked when handle padlocked to OFF position

Handle padlockable with up to three padlocks

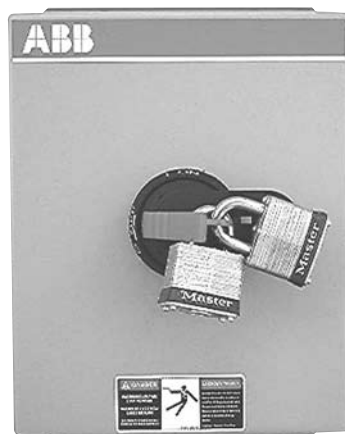

Door interlocked when handle is in ON position. Door interlock can be defeated by authorized personnel.

Pilot devices can be added

**Disconnect
switches**
Non-fusible
Enclosed

General information

Non-fusible, 16A - 3150A

Switch ratings, 16 – 3150 Amps, 600V

| UL General purpose amp rating | Maximum horsepower rating | | | | | | | Wire size for terminal lugs | For wire type | Approval |
|---|---------------------------|------|------|-------------|------|------|--------------------|-----------------------------|---------------|----------|
| | Single phase | | | Three phase | | | | | | |
| | 120V | 200V | 240V | 200V – 208V | 240V | 480V | 600V | | | |
| UL 508 ↑ 16 25 40 | 1 | 2 | 2 | 3 | 5 | 10 | 10 | #18 – 8 | Cu | CSA, UL |
| | 1.5 | 3 | 3 | 7.5 | 7.5 | 15 | 20 | #18 – 8 | Cu | CSA, UL |
| 60 80 | 2 | 5 | 5 | 15 | 15 | 30 | 30 | #14 – 1 | Cu | CSA, UL |
| | 2 | 5 | 5 | 20 | 20 | 40 | 40 | #14 – 1 | Cu | CSA, UL |
| UL 98 ↑ 30 60 100 125 200 400 600 800 1200 1600 2000 3150 ① ↓ | 2 | 5 | 5 | 10 | 10 | 20 | 30 | #14 – 4 | Cu | CSA, UL |
| | 3 | 7.5 | 7.5 | 20 | 20 | 40 | 40 | #14 – 4 | Cu | CSA, UL |
| | 5 | 15 | 15 | 25 | 30 | 50 | 50 | #8 – 1/0 | Cu | CSA, UL |
| | 7.5 | 20 | 20 | 30 | 30 | 75 | 100 | #8 – 1/0 | Cu | CSA, UL |
| | — | — | — | 60 | 75 | 150 | 200 | #6 – 300 kcmil | Cu | CSA, UL |
| | — | — | — | 100 | 125 | 250 | 350 | #2 – 600 kcmil | Cu | CSA, UL |
| | — | — | — | 150 | 200 | 400 | 500 | (2) #2 – 600 kcmil | Cu | CSA, UL |
| | — | — | — | 200 | 250 | 500 | 600 | (2) #2 – 600 kcmil | Cu/Al | CSA, UL |
| | — | — | — | — | — | — | — | (4) #2 – 600 kcmil | Cu/Al | CSA, UL |
| | — | — | — | — | — | — | — | (4) #2 – 600 kcmil | Cu/Al | CSA, UL |
| — | — | — | — | — | — | — | (8) #2 – 600 kcmil | Cu/Al | CSA, UL | |
| — | — | — | — | — | — | — | (8) #2 – 600 kcmil | Cu/Al | IEC | |

Handle ratings, 16 – 3150 Amps, 600V

| Amperage range | Style type | NEMA | Color | Marking | Defeatable | Padlockable | Catalog number suffix | Catalog number |
|----------------|------------|--------------|---------|--------------|------------|-------------|-----------------------|----------------|
| 16 – 100 | Selector | 1,3R,12 | Black | O/I & OFF/ON | Yes | Yes | BJ | OHBS2AJ |
| | Selector | 1,3R,12 | Red/Yel | | | | YJ | OHYS2AJ |
| | Pistol | 1,3R,12 | Black | | | | B6 | OHBS65J6 |
| | Pistol | 1,3R,12 | Red/Yel | | | | Y6 | OHYS65J6 |
| | Pistol | 1,3R,4,4X,12 | Black | | | | B6 | OHBS65L6 |
| | Pistol | 1,3R,4,4X,12 | Red/Yel | | | | Y6 | OHYS65L6 |
| 125 - 200 | Pistol | 1,3R,12 | Black | O/I & OFF/ON | Yes | Yes | B6 | OHB65J6 |
| | | 1,3R,12 | Red/Yel | | | | Y6 | OHY65J6 |
| | | 1,3R,4,4X,12 | Black | | | | B8 | OHB80L6 |
| | | 1,3R,4,4X,12 | Red/Yel | | | | Y8 | OHY80L6 |
| 400 – 3150 | Pistol | 1,3R,12 | Black | O/I & OFF/ON | Yes | Yes | B4 | OHB145J12 |
| | | 1,3R,12 | Red/Yel | | | | Y4 | OHY145J12 |
| | | 1,3R,12 | Black | | | | B7 | OHB175J12 |
| | | 1,3R,12 | Red/Yel | | | | Y7 | OHY175J12 |
| | | 1,3R,4,4X,12 | Black | | | | B4 | OHB145L12 |
| | | 1,3R,4,4X,12 | Red/Yel | | | | Y4 | OHY145L12 |
| | | 1,3R,4,4X,12 | Black | | | | B7 | OHB175L12 |
| | | 1,3R,4,4X,12 | Red/Yel | | | | Y7 | OHY175L12 |
| | | 1,3R,4,4X,12 | Metal | | | | 8 | YASDA-8 |
| 16 – 200 | Pistol | 1,3R,12 | Black | I/O/II | Yes | Yes | B8 | OHB80J6E011 |
| | | 1,3R,4,4X,12 | Black | | | | B8 | OHB80L6E011 |
| 400 | Pistol | 1,3R,12 | Black | I/O/II | Yes | Yes | B4 | OHB145J12E011 |
| 400 – 3150 | Pistol | 1,3R,12 | Black | I/O/II | Yes | Yes | B7 | OHB175J12E011 |
| | | 1,3R,4,4X,12 | Black | | | | B7 | OHB175L12E011 |
| | | 1,3R,4,4X,12 | Metal | | | | 21 | YASDA-21 |
| | | 1,3R,4,4X,12 | Metal | | | | 6 | YASDA-6 |

① IEC rated only.

General information

Fusible, 30A – 800A

Disconnect
switches
Fusible
Enclosed

Switch ratings

| UL general purpose amp rating | Maximum horsepower rating | | | | | | | | Wire size for terminal lugs | For wire type | Approval ① |
|-------------------------------|---------------------------|------|------|------|-------------|------|------|------|-----------------------------|---------------|------------|
| | Single phase | | | | Three phase | | | | | | |
| | 120V | 200V | 240V | 200V | 208V | 240V | 480V | 600V | | | |
| 30 | 2 | 3 | 5 | 5 | 7.5 | 7.5 | 15 | 20 | #18 – 8 | Cu | CSA, UL |
| 60 | 3 | 7.5 | 10 | 15 | 15 | 15 | 30 | 50 | #14 – 4 | Cu | CSA, UL |
| 100 | 5 | 10 | 15 | 25 | 25 | 30 | 60 | 75 | #14 – 2/0 | Cu/Al | CSA, UL |
| 200 | — | — | — | 50 | 50 | 60 | 125 | 150 | #6 – 300 kcmil | Cu/Al | CSA, UL |
| 400 | — | — | — | 100 | 125 | 125 | 250 | 350 | #2 – 600 kcmil | Cu/Al | CSA, UL |
| 600 | — | — | — | 150 | 150 | 200 | 400 | 500 | (2) #2 – 600 kcmil | Cu/Al | CSA, UL |
| 800 | — | — | — | 200 | 200 | 250 | 500 | 600 | (2) #2 – 600 kcmil | Cu/Al | CSA, UL |

Handle ratings

| Amperage range | Style type | NEMA | Color | Marking | Defeatable | Padlockable | Catalog number suffix | Catalog number |
|----------------|------------|--------------|---------|--------------|------------|-------------|-----------------------|----------------|
| 30 | Selector | 1,3R,12 | Black | O/I & OFF/ON | Yes | Yes | BJ | OHBS2AJ |
| | Selector | 1,3R,12 | Red/Yel | | | | YJ | OHYS2AJ |
| | Pistol | 1,3R,12 | Black | | | | B6 | OHBS65J6 |
| | Pistol | 1,3R,12 | Red/Yel | | | | Y6 | OHYS65J6 |
| | Pistol | 1,3R,4,4X,12 | Black | | | | B6 | OHBS65L6 |
| | Pistol | 1,3R,4,4X,12 | Red/Yel | | | | Y6 | OHYS65L6 |
| 60 – 200 | Pistol | 1,3R,12 | Black | O/I & OFF/ON | Yes | Yes | B6 | OHBS65J6 |
| | | 1,3R,12 | Red/Yel | | | | Y6 | OHYS65J6 |
| | | 1,3R,12 | Black | | | | B8 | OHBS80J6 |
| | | 1,3R,12 | Red/Yel | | | | Y8 | OHYS80J6 |
| | | 1,3R,4,4X,12 | Black | | | | B8 | OHBS80L6 |
| | | 1,3R,4,4X,12 | Red/Yel | | | | Y8 | OHYS80L6 |
| 400 – 800 | Pistol | 1,3R,12 | Black | O/I & OFF/ON | Yes | Yes | B4 | OHBS145J12 |
| | | 1,3R,12 | Red/Yel | | Yes | | Y4 | OHYS145J12 |
| | | 1,3R,12 | Black | | Yes | | B7 | OHBS175J12 |
| | | 1,3R,12 | Red/Yel | | Yes | | Y7 | OHYS175J12 |
| | | 1,3R 4,4X,12 | Black | | Yes | | B4 | OHBS145L12 |
| | | 1,3R,4,4X,12 | Red/Yel | | Yes | | Y4 | OHYS145L12 |
| | | 1,3R 4,4X,12 | Black | | Yes | | B7 | OHBS175L12 |
| | | 1,3R,4,4X,12 | Red/Yel | | Yes | | Y7 | OHYS175L12 |
| | | 1,3R,4,4X,12 | Metal | | No | | 8 | YASDA-8 |
| 30 | Pistol | 1,3R,12 | Black | I/O/II | Yes | Yes | B6 | OHBS65J6E011 |
| | | 1,3R,4,4X,12 | | | | | Y6 | OHYS65L6E011 |
| 60 – 200 | Pistol | 1,3R,12 | Black | I/O/II | Yes | Yes | B8 | OHBS80J6E011 |
| | | 1,3R,4,4X,12 | | | | | Y8 | OHYS80L6E011 |
| 400 – 800 | Pistol | 1,3R,12 | Black | I/O/II | Yes | Yes | B4 | OHBS145J12E011 |
| | Pistol | 1,3R,4,4X,12 | Black | | Yes | | B4 | OHBS145L12E011 |
| | Pistol | 1,3R,12 | Black | | Yes | | B7 | OHBS175J12E011 |
| | Pistol | 1,3R,4,4X,12 | Black | | Yes | | B7 | OHBS175L12E011 |
| | Metallic | 1,3R,4,4X,12 | Metal | | No | | 21 | YASDA-21 |
| | Metallic | 1,3R,4,4X,12 | Metal | | No | | 6 | YASDA-6 |

① Fusible switches are UL listed to the UL98 standard.

**Disconnect
switches**
Non-fusible
Enclosed

**3 pole
16A – 3150A**



NF32X-3PB6C



NF63X-3PB6A

**3 Pole, 600V, 16A – 80A
Selector handle**

| UL general purpose amp rating | | NEMA Enclosure type | | | | | | | |
|-------------------------------|--|---------------------|-------------|----------------|-------------|----------------|------------------------------------|------------------------------------|------------|
| | | 1 | | 3R | | 4 | | 4X Stainless | |
| | | Catalog number | List price | Catalog number | List price | Catalog number | List price | Catalog number | List price |
| UL 508 | | 16 | NF161-3PBJC | \$ 185 | NF163-3PBJC | \$ 259 | Not available with selector handle | Not available with selector handle | |
| | | 25 | NF251-3PBJC | 190 | NF253-3PBJC | 264 | | | |
| | | 40 | NF321-3PBJC | 205 | NF323-3PBJC | 279 | | | |
| | | 60 | NF451-3PBJB | 245 | NF453-3PBJB | 320 | | | |
| | | 80 | NF631-3PBJA | 280 | NF633-3PBJA | 354 | | | |

**3 Pole, 600V, 16A – 3150A
Pistol handle**

| UL general purpose amp rating | | NEMA Enclosure type | | | | | | | | |
|-------------------------------|--|---------------------|---------------|----------------|---------------|----------------|---------------|----------------|---------------|--------|
| | | 1 | | 3R | | 4 | | 4X Stainless | | |
| | | Catalog number | List price | Catalog number | List price | Catalog number | List price | Catalog number | List price | |
| UL 508 | | 16 | NF161-3PB6C | \$ 235 | NF163-3PB6C | \$ 309 | NF164-3PB6A | \$ 475 | NF16X-3PB6C ② | \$ 585 |
| | | 25 | NF251-3PB6C | 240 | NF253-3PB6C | 314 | NF254-3PB6A | 480 | NF25X-3PB6C ② | 590 |
| | | 40 | NF321-3PB6C | 255 | NF323-3PB6C | 329 | NF324-3PB6A | 495 | NF32X-3PB6C ② | 605 |
| | | 60 | NF451-3PB6B | 295 | NF453-3PB6B | 370 | NF454-3PB6B | 525 | NF45X-3PB6B | 635 |
| | | 80 | NF631-3PB6A | 330 | NF633-3PB6A | 404 | NF634-3PB6A | 550 | NF63X-3PB6A | 660 |
| 18 UL 98 | | 30 | NF301-3PB6C | 510 | NF303-3PB6C | 780 | NF304-3PB6C | 1,090 | NF30X-3PB6C | 1,200 |
| | | 60 | NF601-3PB6C | 560 | NF603-3PB6C | 830 | NF604-3PB6C | 1,140 | NF60X-3PB6C | 1,250 |
| | | 100 | NF1001-3PB6B | 610 | NF1003-3PB6B | 880 | NF1004-3PB6B | 1,190 | NF100X-3PB6B | 1,300 |
| | | 125 | NF1251-3PB6A | 1,100 | NF1253-3PB6A | 1,400 | NF1254-3PB8A | 2,800 | NF125X-3PB8A | 3,500 |
| | | 200 | NF2001-3PB8B | 1,300 | NF2003-3PB8B | 1,650 | NF2004-3PB8B | 3,520 | NF200X-3PB8B | 4,400 |
| | | 400 | NF4001-3PB4B | 2,600 | NF4003-3PB4B | 2,800 | NF4004-3PB4B | 6,400 | NF400X-3PB4B | 8,000 |
| | | 600 | NF6001-3PB7B | 4,800 | NF6003-3PB7B | 5,000 | NF6004-3PB7B | 9,600 | NF600X-3PB7B | 12,000 |
| | | 800 | NF8001-3PB4A | 8,000 | NF8003-3PB4A | 9,400 | NF8004-3PB4A | 15,200 | NF800X-3PB4A | 19,000 |
| | | 1200 | NF12001-3PB4A | 10,000 | NF12003-3PB4A | 11,800 | NF12004-3PB4A | 18,000 | NF1200X-3PB4A | 22,500 |
| | | 1600 | NF16001-3P8A | 19,000 | NF16003-3P8A | 20,800 | NF16004-3P8A | 30,400 | NF1600X-3P8A | 38,000 |
| | | 2000 | NF20001-3P8A | 23,000 | NF20003-3P8A | 25,000 | NF20004-3P8A | 35,200 | NF2000X-3P8A | 44,000 |
| | | 3150 ① | NF31501-3P8A | 28,000 | NF31503-3P8A | 30,000 | NF31504-3P8A | 39,200 | NF3150X-3P8A | 49,000 |

NOTE: All enclosed switches are provided with a black handle; however, most handles can be substituted with a red and yellow handle if desired. Please substitute the handle suffix code (2nd and 3rd from last characters) with the red/yellow handle catalog number suffix from page 18.130. There is no additional price adder for changing to a red/yellow handle of equal ratings and style.

EXAMPLE: A red/yellow selector handle for an NF161-3PBJA can be substituted for the black selector handle by using the "YJ" suffix instead of the "BJ" suffix, new catalog #NF161-3PYJA.

① IEC rated only.
② New Washdown.

3 pole 16A – 3150A

Disconnect
switches
Non-fusible
Enclosed



NF25P-3PY6A

3 Pole, 600V, 16A – 80A Selector handle

| UL general purpose amp rating | | NEMA Enclosure type | | | | | |
|-------------------------------|---------------|---------------------|------------|----------------|------------|----------------|------------|
| | | 12 Plastic | | 12 | | 7 & 9 | |
| | | Catalog number | List price | Catalog number | List price | Catalog number | List price |
| UL 508 | 16 | NF16P-3PBJA | \$ 295 | NF162-3PBJC | \$ 259 | — | — |
| | 16, oversized | — | — | — | — | — | — |
| | 25 | NF25P-3PBJA | 300 | NF252-3PBJC | 264 | — | — |
| | 25, oversized | — | — | — | — | — | — |
| | 40 | NF32P-3PBJA | 315 | NF322-3PBJC | 279 | — | — |
| | 40, oversized | — | — | — | — | — | — |
| | 60 | NF45P-3PBJB | 350 | NF452-3PBJB | 320 | — | — |
| | 80 | NF63P-3PBJA | 380 | NF632-3PBJA | 354 | — | — |

3 Pole, 600V, 16A – 3150A Pistol handle

| UL general purpose amp rating | | NEMA Enclosure type | | | | | |
|-------------------------------|------|---------------------|------------|----------------|------------|----------------|------------|
| | | 4X Plastic | | 12 | | 7 & 9 | |
| | | Catalog number | List price | Catalog number | List price | Catalog number | List price |
| UL 508 | 16 | NF16P-3PB6A | \$ 345 | NF162-3PB6C | \$ 309 | NF167-3P | \$ 1,900 |
| | 25 | NF25P-3PB6A | 350 | NF252-3PB6C | 314 | NF257-3P | 1,925 |
| | 40 | NF32P-3PB6A | 365 | NF322-3PB6C | 329 | NF327-3P | 1,950 |
| | 60 | NF45P-3PB6B | 400 | NF452-3PB6B | 370 | NF457-3P | 3,600 |
| | 80 | NF63P-3PB6A | 430 | NF632-3PB6A | 400 | NF637-3P | 3,630 |
| UL 98 | 30 | NF30P-3PB6B | 875 | NF302-3PB6B | 780 | NF307-3P | 4,150 |
| | 60 | NF60P-3PB6B | 925 | NF602-3PB6C | 560 | NF607-3P | 4,200 |
| | 100 | NF100P-3PB6B | 975 | NF1002-3PB6B | 880 | NF1007-3P | 4,250 |
| | 125 | NF125P-3PB8A | 3,000 | NF1252-3PB6A | 1,400 | — | — |
| | 200 | NF200P-3PB8B | 4,000 | NF2002-3PB8B | 1,600 | — | — |
| | 400 | NF400P-3PB4B | 6,000 | NF4002-3PB4B | 2,900 | — | — |
| | 600 | NF600P-3PB7B | 10,000 | NF6002-3PB7B | 5,100 | — | — |
| | 800 | NF800P-3PB4A | 16,000 | NF8002-3PB4A | 8,400 | — | — |
| | 1200 | NF1200P-3PB4A | 19,000 | NF12002-3PB4A | 10,400 | — | — |
| | 1600 | — | — | NF16002-3P8A | 19,400 | — | — |
| | 2000 | — | — | NF20002-3P8A | 23,400 | — | — |
| | 3150 | — | — | NF31502-3P8A | 28,400 | — | — |

**Disconnect
switches**
Non-fusible
Enclosed

2 pole ① 125A – 3150A

2 Pole, 600V, 125A – 3150A

| UL general purpose amp rating | | NEMA Enclosure type | | | | | | | |
|---|------|---------------------|------------|----------------|------------|----------------|------------|----------------|------------|
| | | 1 | | 3R | | 4 | | 4X Stainless | |
| | | Catalog number | List price | Catalog number | List price | Catalog number | List price | Catalog number | List price |
|  | 125 | NF1251-2PB6A | \$ 825 | NF1253-2PB6A | \$ 1,050 | NF1254-2PB8A | \$ 2,100 | NF125X-2PB8A | \$ 2,625 |
| | 200 | NF2001-2PB8C | 1,170 | NF2003-2PB8C | 1,485 | NF2004-2PB8C | 3,170 | NF200X-2PB8C | 3,960 |
| | 400 | NF4001-2PB4C | 2,340 | NF4003-2PB4C | 2,520 | NF4004-2PB4C | 5,750 | NF400X-2PB4C | 7,200 |
| | 600 | NF6001-2PB7B | 4,320 | NF6003-2PB7B | 4,500 | NF6004-2PB7B | 8,640 | NF600X-2PB7B | 10,800 |
| | 800 | NF8001-2PB4A | 7,200 | NF8003-2PB4A | 8,460 | NF8004-2PB4A | 13,680 | NF800X-2PB4A | 17,100 |
| | 1200 | NF12001-2PB4A | 9,000 | NF12003-2PB4A | 10,620 | NF12004-2PB4A | 16,200 | NF1200X-2PB4A | 20,250 |
| | 1600 | NF16001-2P8A | 17,100 | NF16003-2P8A | 18,720 | NF16004-2P8A | 27,360 | NF1600X-2P8A | 34,200 |
| | 2000 | NF20001-2P8A | 20,700 | NF20003-2P8A | 22,500 | NF20004-2P8A | 31,680 | NF2000X-2P8A | 39,600 |
| | 3150 | NF31501-2P8A | 25,200 | NF31503-2P8A | 27,000 | NF31504-2P8A | 35,280 | NF3150X-2P8A | 44,100 |

2 Pole, 600V, 125A – 3150A

| UL general purpose amp rating | | NEMA Enclosure type | | | |
|--|--------|---------------------|------------|----------------|------------|
| | | 4X Plastic | | 12 | |
| | | Catalog number | List price | Catalog number | List price |
|  | 125 | NF125P-2PB8A | \$ 2,250 | NF1252-2PB6A | \$ 1,050 |
| | 200 | NF200P-2PB8C | 3,600 | NF2002-2PB8C | 1,440 |
| | 400 | NF400P-2PB4C | 5,400 | NF4002-2PB4C | 2,610 |
| | 600 | NF600P-2PB7B | 9,000 | NF6002-2PB7B | 4,590 |
| | 800 | NF800P-2PB4A | 14,400 | NF8002-2PB4A | 7,560 |
| | 1200 | NF1200P-2PB4A | 17,100 | NF12002-2PB4A | 9,360 |
| | 1600 | — | — | NF16002-2P8A | 17,460 |
| | 2000 | — | — | NF20002-2P8A | 21,060 |
| | 3150 ① | — | — | NF31502-2P8A | 25,560 |

① 16A – 100A switches are not available in 2 pole versions; use 3 pole.

4 pole 16A – 3150A

Disconnect
switches
Non-fusible
Enclosed

4 Pole, 600V, 16A – 3150A

| UL general purpose amp rating | | NEMA Enclosure type | | | | | | | | |
|----------------------------------|--|---------------------|---------------|----------------|---------------|----------------|---------------|----------------|---------------|--------|
| | | 1 | | 3R | | 4 | | 4X Stainless | | |
| | | Catalog number | List price | Catalog number | List price | Catalog number | List price | Catalog number | List price | |
| UL508 | | 16 | NF161-4PB6C | \$ 295 | NF163-4PB6C | \$ 369 | NF164-4PB6A | \$ 530 | NF16X-4PB6C | \$ 665 |
| | | 25 | NF251-4PB6C | 300 | NF253-4PB6C | 374 | NF254-4PB6A | NF | NF25X-4PB6C | 670 |
| | | 40 | NF321-4PB6C | 321 | NF323-4PB6C | 384 | NF324-4PB6A | NF 545 | NF32X-4PB6C | 680 |
| UL98 | | 60 | NF451-4PB6B | 360 | NF453-4PB6B | 434 | NF454-4PB6B | 570 | NF45X-4PB6B | 700 |
| | | 80 | NF631-4PB6A | 410 | NF633-4PB6A | 484 | NF634-4PB6A | 595 | NF63X-4PB6A | 740 |
| | | 30 | NF301-4PB6B | 650 | NF303-4PB6B | 988 | NF304-4PB6B | 1,200 | NF30X-4PB6B | 1,525 |
| | | 60 | NF601-4PB6B | 700 | NF603-4PB6B | 1,038 | NF604-4PB6B | 1,250 | NF60X-4PB6B | 1,575 |
| | | 100 | NF1001-4PB6B | 750 | NF1003-4PB6B | 1,088 | NF1004-4PB6B | 1,300 | NF100X-4PB6B | 1,625 |
| | | 125 | NF1251-4PB6A | 1,375 | NF1253-4PB6A | 1,675 | NF1254-4PB6A | 3,500 | NF125X-4PB8A | 4,375 |
| | | 200 | NF2001-4PB8B | 1,625 | NF2003-4PB8B | 2,063 | NF2004-4PB8B | 4,400 | NF200X-4PB8B | 5,500 |
| | | 400 | NF4001-4PB4B | 3,250 | NF4003-4PB4B | 3,500 | NF4004-4PB4B | 8,000 | NF400X-4PB4B | 10,000 |
| | | 600 | NF6001-4PB7B | 6,000 | NF6003-4PB7B | 6,250 | NF6004-4PB7B | 12,000 | NF600X-4PB7B | 15,000 |
| | | 800 | NF8001-4PB4A | 10,000 | NF8003-4PB4A | 11,750 | NF8004-4PB4A | 19,000 | NF800X-4PB4A | 23,750 |
| | | 1200 | NF12001-4PB4A | 12,500 | NF12003-4PB4A | 14,750 | NF12004-4PB4A | 22,500 | NF1200X-4PB4A | 28,125 |
| | | 1600 | NF16001-4P8A | 23,750 | NF16003-4P8A | 26,000 | NF16004-4P8A | 38,800 | NF1600X-4P8A | 47,500 |
| | | 2000 | NF20001-4P8A | 28,750 | NF20003-4P8A | 31,250 | NF20004-4P8A | 44,000 | NF2000X-4P8A | 55,000 |
| | | 3150 ① | NF31501-4P8A | 35,000 | NF31503-4P8A | 37,500 | NF31504-4P8A | 49,000 | NF3150X-4P8A | 61,250 |

4 Pole, 600V, 16A – 3150A



| UL general purpose amp rating | | NEMA Enclosure type | | | | | | |
|----------------------------------|--|---------------------|---------------|----------------|---------------|----------------|------------|----------|
| | | 4X Plastic | | 12 | | 7 & 9 | | |
| | | Catalog number | List price | Catalog number | List price | Catalog number | List price | |
| UL508 | | 16 | NF16P-4PB6A | \$ 405 | NF162-4PB6C | \$ 369 | NF167-4P | \$ 2,025 |
| | | 25 | NF25P-4PB6A | 410 | NF252-4PB6C | 374 | NF257-4P | 2,050 |
| | | 40 | NF32P-4PB6A | 420 | NF322-4PB6C | 384 | NF327-4P | 2,075 |
| UL98 | | 60 | NF45P-4PB6B | 465 | NF452-4PB6B | 434 | NF457-4P | 3,700 |
| | | 80 | NF63P-4PB6A | 510 | NF632-4PB6A | 484 | NF637-4P | 3,730 |
| | | 30 | NF30P-4PB6B | 1,100 | NF302-4PB6B | 925 | NF307-4P | 4,300 |
| | | 60 | NF60P-4PB6B | 1,150 | NF602-4PB6B | 975 | NF607-4P | 4,350 |
| | | 100 | NF100P-4PB6B | 1,200 | NF1002-4PB6B | 1,025 | NF1007-4P | 4,400 |
| | | 125 | NF125P-4PB8A | 3,750 | NF1252-4PB6A | 1,750 | — | — |
| | | 200 | NF200P-4PB8B | 5,000 | NF2002-4PB8B | 2,000 | — | — |
| | | 400 | NF400P-4PB4B | 7,500 | NF4002-4PB4B | 3,625 | — | — |
| | | 600 | NF600P-4PB7B | 12,500 | NF6002-4PB7B | 6,375 | — | — |
| | | 800 | NF800P-4PB4A | 20,000 | NF8002-4PB4A | 10,500 | — | — |
| | | 1200 | NF1200P-4PB4A | 23,750 | NF12002-4PB4A | 13,000 | — | — |
| | | 1600 | — | — | NF16002-4P8A | 24,250 | — | — |
| | | 2000 | — | — | NF20002-4P8A | 29,240 | — | — |
| | | 3150 | — | — | NF31502-4P8A | 35,500 | — | — |

① IEC rated only.



**Disconnect
switches
Non-fusible
Enclosed**

6 pole 16A – 1200A

6 Pole, 600V, 16A – 1200A

| UL general purpose amp rating ① | | NEMA Enclosure type | | | | | | | |
|--|--------------|---------------------|---------------|----------------|--------------|----------------|--------------|----------------|------------|
| | | 1 | | 3R | | 4 | | 4X Stainless | |
| | | Catalog number | List price | Catalog number | List price | Catalog number | List price | Catalog number | List price |
| UL508  | 16 | NF161-6PB6C | \$ 580 | NF163-6PB6C | \$ 728 | NF164-6PB6A | \$ 1,080 | NF16X-6PB6C | \$ 1,350 |
| | 25 | NF251-6PB6C | 590 | NF253-6PB6C | 738 | NF254-6PB6A | 1,090 | NF25X-6PB6C | 1,360 |
| | 40 | NF321-6PB6C | 610 | NF323-6PB6C | 758 | NF324-6PB6A | 1,110 | NF32X-6PB6C | 1,380 |
| UL98  | 60 | NF451-6PB6B | 690 | NF453-6PB6B | 838 | NF454-6PB6B | 1,140 | NF45X-6PB6B | 1,430 |
| | 80 | NF631-6PB6A | 770 | NF633-6PB6A | 918 | NF634-6PB6A | 1,185 | NF63X-6PB6A | 1,480 |
| | 30 | NF301-6PB6B | 1,230 | NF303-6PB6B | 1,770 | NF304-6PB6B | 2,110 | NF30X-6PB6B | 2,660 |
| | 60 | NF601-6PB6C | 850 | NF603-6PB6B | 1,820 | NF604-6PB6B | 2,160 | NF60X-6PB6B | 2,710 |
| | 100 | NF1001-6PB6B | 1,330 | NF1003-6PB6B | 1,870 | NF1004-6PB6B | 2,210 | NF100X-6PB6B | 2,760 |
| | 125 | NF1251-6PB2A | 2,200 | NF1253-6PB2A | 3,280 | NF1254-6PB4A | 5,600 | NF125X-6PB4A | 7,000 |
| | 200 | NF2001-6PB4B | 2,950 | NF2003-6PB4B | 3,650 | NF2004-6PB4B | 7,320 | NF200X-6PB4B | 9,150 |
| | 400 | NF4001-6PB8B | 5,860 | NF4003-6PB8B | 5,960 | NF4004-6PB8B | 13,090 | NF400X-6P8B | 16,360 |
| | 600 | NF6001-6PB8B | 9,960 | NF6003-6PB8B | 10,360 | NF6004-6PB8B | 19,490 | NF600X-6P8B | 16,360 |
| | 800 | NF8001-6PB8A | 16,360 | NF8003-6PB4A | 19,800 | NF8004-6PB4A | 30,690 | NF800X-6P8A | 38,360 |
| 1200 | NF12001-6P8A | 20,360 | NF12003-6PB4A | 23,960 | NF12004-6P8A | 36,290 | NF1200X-6P8A | 45,360 | |

6 Pole, 600V, 16A – 1200A

| UL general purpose amp rating | | NEMA Enclosure type | | | | | | | |
|--|--------------|---------------------|--------------|----------------|------------|----------------|------------|----------------|------------|
| | | 4X Plastic | | 12 | | 7 & 9 | | IP65 Plastic | |
| | | Catalog number | List price | Catalog number | List price | Catalog number | List price | Catalog number | List price |
| UL508  | 16 | NF16P-6PB6A | \$ 800 | NF162-6PB6C | \$ 728 | NF167-6P | \$ 3,750 | NF16E-6PB6B | \$ 410 |
| | 25 | NF25P-6PB6A | 810 | NF252-6PB6C | 738 | NF257-6P | 3,775 | NF25E-6PB6B | 420 |
| | 40 | NF32P-6PB6A | 830 | NF322-6PB6C | 758 | NF327-6P | 3,800 | NF32E-6PB6B | 450 |
| UL98  | 60 | NF45P-6PB6B | 930 | NF452-6PB6B | 838 | NF457-6P | 4,275 | NF45E-6PB6B | 520 |
| | 80 | NF63P-6PB6A | 1,030 | NF632-6PB6A | 918 | NF637-6P | 4,325 | NF63E-6PB6B | 770 |
| | 30 | NF30P-6PB6B | 1,900 | NF302-6PB6B | 1,670 | — | — | NF30E-6PB6B | 1,230 |
| | 60 | NF60P-6PB6B | 1,950 | NF602-6PB6B | 1,720 | — | — | NF60E-6PB6B | 1,280 |
| | 100 | NF100P-6PB6B | 2,000 | NF1002-6PB6B | 1,770 | — | — | NF100E-6PB6B | 1,330 |
| | 125 | NF125P-6PB4A | 6,000 | NF1252-6PB4A | 2,800 | — | — | — | — |
| | 200 | NF200P-6PB4B | 8,350 | NF2002-6PB4B | 3,550 | — | — | — | — |
| | 400 | NF400P-6P8B | 12,360 | NF4002-6P8B | 6,160 | — | — | — | — |
| | 600 | NF600P-6P8B | 20,360 | NF6002-6P8B | 10,560 | — | — | — | — |
| | 800 | NF800P-6P8A | 32,360 | NF8002-6P8A | 17,800 | — | — | — | — |
| 1200 | NF1200P-6P8A | 38,360 | NF12002-6P8A | 21,800 | — | — | — | — | |

①  = Three poles

3 pole double throw 16A – 1200A

Disconnect
switches
Non-fusible
Enclosed

3 Pole, 600V, 16A – 1200A

NEMA Enclosure type

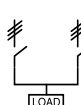
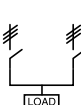
| UL general purpose amp rating | | 1 | | 3R | | 4 | | 4X Stainless | |
|--|---------------|-------------------|---------------|-------------------|---------------|-------------------|---------------|-------------------|---------------|
| | | Catalog number | List price | Catalog number | List price | Catalog number | List price | Catalog number | List price |
| UL508  | 16 | NF161-3TB8C | \$ 760 | NF163-3TB8C | \$ 908 | NF164-3TB8C | \$ 1,200 | NF16X-3TB8C | \$ 1,850 |
| | 25 | NF251-3TB8C | 770 | NF253-3TB8C | 918 | NF254-3TB8C | 1,230 | NF25X-3TB8C | 1,880 |
| | 40 | NF321-3TB8C | 790 | NF323-3TB8C | 954 | NF324-3TB8C | 1,260 | NF32X-3TB8C | 1,950 |
| UL98  | 60 | NF451-3TB8B | 870 | NF453-3TB8B | 1,018 | NF454-3TB8B | 1,340 | NF45X-3TB8B | 3,500 |
| | 80 | NF631-3TB8A | 950 | NF633-3TB8A | 1,098 | NF634-3TB8A | 1,420 | NF63X-3TB8A | 3,600 |
| | 30 | NF301-3TB8B | 1,410 | NF303-3TB8B | 1,830 | NF304-3TB8B | 2,400 | NF30X-3TB8B | 3,900 |
| | 60 | NF601-3TB8B | 1,460 | NF603-3TB8B | 1,880 | NF604-3TB8B | 2,450 | NF60X-3TB8B | 3,950 |
| | 100 | NF1001-3TB8B | 1,510 | NF1003-3TB8B | 1,930 | NF1004-3TB8B | 2,500 | NF100X-3TB8B | 4,000 |
| | 125 | NF1251-3TB8A | 2,380 | NF1253-3TB8A | 2,980 | NF1254-3TB8A | 3,500 | NF125X-3TB8A | 5,000 |
| | 200 | NF2001-3TB4B | 3,150 | NF2003-3TB4B | 3,850 | NF2004-3TB4B | 7,480 | NF200X-3TB4B | 9,350 |
| | 400 | NF4001-3TB4B | 5,960 | NF4003-3TB4B | 6,160 | NF4004-3TB4B | 13,250 | NF400X-3TB4B | 16,560 |
| | 600 | NF6001-3TB4A | 10,260 | NF6003-3TB4A | 10,660 | NF6004-3TB4A | 19,730 | NF600X-3TB4A | 24,660 |
| | 800 | NF8001-3TB4A | 16,660 | NF8003-3TB4A | 19,460 | NF8004-3TB4A | 30,920 | NF800X-3TB4A | 38,660 |
| 1200 | NF12001-3TB4A | 20,660 | NF12003-3TB4A | 24,260 | NF12004-3TB4A | 36,530 | NF1200X-3TB4A | 45,660 | |

3 Pole, 600V, 16A – 1200A

NEMA Enclosure type

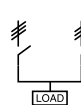
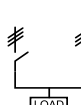
| UL general purpose amp rating | | 4X Plastic | | 12 | |
|---|---------------|-------------------|---------------|-------------------|---------------|
| | | Catalog number | List price | Catalog number | List price |
| UL508  | 16 | NF16P-3TB8A | \$ 1,000 | NF162-3TB8C | \$ 908 |
| | 25 | NF25P-3TB8A | 1,040 | NF252-3TB8C | 918 |
| | 40 | NF32P-3TB8A | 1,100 | NF322-3TB8C | 938 |
| UL98  | 60 | NF45P-3TB8B | 1,180 | NF452-3TB8B | 1,018 |
| | 80 | NF63P-3TB8A | 1,260 | NF632-3TB8A | 1,098 |
| | 30 | NF30P-3TB8B | 2,000 | NF302-3TB8B | 1,730 |
| | 60 | NF60P-3TB8B | 2,050 | NF602-3TB8B | 1,830 |
| | 100 | NF100P-3TB8B | 2,100 | NF1002-3TB8B | 1,930 |
| | 125 | NF125P-3TB8A | 3,200 | NF1252-3TB8A | 2,980 |
| | 200 | NF200P-3TB4B | 8,550 | NF2002-3TB4B | 3,750 |
| | 400 | NF400P-3TB4B | 12,560 | NF4002-3TB4B | 6,460 |
| | 600 | NF600P-3TB4A | 20,660 | NF6002-3TB4A | 10,760 |
| | 800 | NF800P-3TB4A | 32,660 | NF8002-3TB4A | 17,460 |
| 1200 | NF1200P-3TB4A | 38,660 | NF12002-3TB4A | 21,460 | |

**Disconnect
switches**
Non-fusible
Enclosed

3 pole bypass 16A – 1200A

3 Pole, 600V, 16A – 1200A

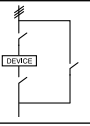
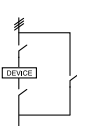
| UL general purpose amp rating | | NEMA Enclosure type | | | | | | | | |
|----------------------------------|---|---------------------|--------------|----------------|--------------|----------------|--------------|----------------|--------------|----------|
| | | 1 | | 3R | | 4 | | 4X Stainless | | |
| | | Catalog number | List price | Catalog number | List price | Catalog number | List price | Catalog number | List price | |
| UL508 |  | 16 | NF161-3BB8A | \$ 1,045 | NF163-3BB8A | \$ 1,267 | NF164-3BB8A | \$ 1,480 | NF16X-3BB8A | \$ 3,740 |
| | | 25 | NF251-3BB8A | 1,060 | NF253-3BB8A | 1,282 | NF254-3BB8A | 1,540 | NF25X-3BB8A | 3,820 |
| | | 40 | NF321-3BB8A | 1,090 | NF323-3BB8A | 1,297 | NF324-3BB8A | 1,600 | NF32X-3BB8A | 3,900 |
| | | 60 | NF451-3BB8B | 1,215 | NF453-3BB8B | 1,312 | NF454-3BB8B | 1,750 | NF45X-3BB8B | 4,050 |
| | | 80 | NF631-3BB8A | 1,340 | NF633-3BB8A | 1,432 | NF634-3BB8A | 1,850 | NF63X-3BB8A | 4,150 |
| UL98 |  | 30 | NF301-3BB8B | 1,970 | NF303-3BB8B | 2,300 | NF304-3BB8B | 2,800 | NF30X-3BB8B | 4,800 |
| | | 60 | NF601-3BB8B | 2,070 | NF603-3BB8B | 2,400 | NF604-3BB8B | 2,900 | NF60X-3BB8B | 4,900 |
| | | 100 | NF1001-3BB8B | 2,170 | NF1003-3BB8B | 2,500 | NF1004-3BB8B | 3,000 | NF100X-3BB8B | 5,000 |
| | | 125 | — | — | — | — | — | — | — | — |
| | | 200 | — | — | — | — | — | — | — | — |
| | | 400 | NF4001-3B6B | 8,460 | NF4003-3B6B | 9,060 | NF4004-3B6B | 19,750 | NF400X-3B6B | 24,660 |
| | | 600 | NF6001-3B6B | 15,060 | NF6003-3B6B | 15,660 | NF6004-3B6B | 29,330 | NF600X-3B6B | 36,660 |
| | | 800 | NF8001-3B6A | 24,660 | NF8003-3B6A | 28,860 | NF8004-3B6A | 46,130 | NF800X-3B6A | 57,660 |
| | | 1200 | NF12001-3B6A | 30,660 | NF12003-3B6A | 30,060 | NF12004-3B6A | 55,040 | NF1200X-3B6A | 68,800 |

3 Pole, 600V, 16A – 1200A

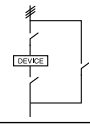
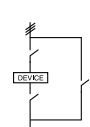
| UL general purpose amp rating | | NEMA Enclosure type | | | | |
|----------------------------------|---|---------------------|--------------|----------------|--------------|----------|
| | | 4X Plastic | | 12 | | |
| | | Catalog number | List price | Catalog number | List price | |
| UL508 |  | 16 | NF16P-3BB8A | \$ 1,300 | NF162-3BB8A | \$ 1,267 |
| | | 25 | NF25P-3BB8A | 1,325 | NF252-3BB8A | 1,282 |
| | | 40 | NF32P-3BB8A | 1,350 | NF322-3BB8A | 1,297 |
| | | 60 | NF45P-3BB8B | 1,420 | NF452-3BB8B | 1,312 |
| | | 80 | NF63P-3BB8A | 1,550 | NF632-3BB8A | 1,432 |
| UL 98 |  | 30 | NF30P-3BB8B | 2,400 | NF302-3BB8B | 2,300 |
| | | 60 | NF60P-3BB8B | 2,500 | NF602-3BB8B | 2,400 |
| | | 100 | NF100P-3BB8B | 2,600 | NF1002-3BB8B | 2,500 |
| | | 125 | — | — | — | — |
| | | 200 | — | — | — | — |
| | | 400 | NF400P-3B6B | 18,660 | NF4002-3B6B | 9,360 |
| | | 600 | NF600P-3B6B | 30,660 | NF6002-3B6B | 15,960 |
| | | 800 | NF800P-3B6A | 48,660 | NF8002-3B6A | 25,860 |
| | | 1200 | NF1200P-3B6A | 57,660 | NF12002-3B6A | 31,860 |

3 pole mechanically interlocked 16A – 1200A

Disconnect
switches
Non-fusible
Enclosed

3 Pole, 600V, 16A – 1200A

| | | NEMA Enclosure type | | | | | | | | |
|-------------------------------|---------------|---------------------|---------------|----------------|---------------|----------------|---------------|----------------|--------------|----------|
| | | 1 | | 3R | | 4 | | 4X Stainless | | |
| UL general purpose amp rating | | Catalog number | List price | Catalog number | List price | Catalog number | List price | Catalog number | List price | |
| UL508 | | 16 | NF161-3MB6A | \$ 640 | NF163-3MB6A | \$ 788 | NF164-3MB6A | \$ 1,120 | NF16X-3MB6A | \$ 1,410 |
| | | 25 | NF251-3MB6A | 650 | NF253-3MB6A | 798 | NF254-3MB6A | 1,160 | NF25X-3MB6A | 1,420 |
| | | 40 | NF321-3MB6A | 670 | NF323-3MB6A | 818 | NF324-3MB6A | 1,170 | NF32X-3MB6A | 1,440 |
| UL98 | | 60 | NF451-3MB6B | 750 | NF453-3MB6B | 908 | NF454-3MB6B | 1,200 | NF45X-3MB6B | 1,490 |
| | | 80 | NF631-3MB6A | 830 | NF633-3MB6A | 978 | NF634-3MB6A | 1,245 | NF63X-3MB6A | 1,540 |
| | | 30 | NF301-3MB6B | 1,290 | NF303-3MB6B | 1,830 | NF304-3MB6B | 2,170 | NF30X-3MB6B | 2,700 |
| | | 60 | NF601-3MB6B | 1,340 | NF603-3MB6B | 1,880 | NF604-3MB6B | 2,210 | NF60X-3MB6B | 2,770 |
| | | 100 | NF1001-3MB6B | 1,390 | NF1003-3MB6B | 1,930 | NF1004-3MB6B | 2,270 | NF100X-3MB6B | 2,800 |
| | | 125 | NF1251-3MB6A | 2,260 | NF1253-3MB6A | 2,860 | NF1254-3MB8A | 5,660 | NF125X-3MB8A | 7,060 |
| | | 200 | NF2001-3MB8B | 3,010 | NF2003-3MB8B | 3,710 | NF2004-3MB8B | 7,380 | NF200X-3MB8B | 9,210 |
| | | 400 | NF4001-3MB4B | 5,920 | NF4003-3MB4B | 6,030 | NF4004-3MB4B | 13,150 | NF400X-3MB4B | 16,420 |
| | | 600 | NF6001-3MB4B | 10,020 | NF6003-3MB4B | 10,420 | NF6004-3MB4B | 19,550 | NF600X-3MB4B | 24,420 |
| | | 800 | NF8001-3MB4A | 16,420 | NF8003-3MB4A | 19,860 | NF8004-3MB4A | 30,750 | NF800X-3MB4A | 38,420 |
| 1200 | NF12001-3MB4A | 20,420 | NF12003-3MB4A | 24,020 | NF12004-3MB4A | 36,350 | NF1200X-3MB4A | 45,420 | | |

3 Pole, 600V, 16A – 1200A

| | | NEMA Enclosure type | | | | |
|-------------------------------|---------------|---------------------|---------------|----------------|--------------|--------|
| | | 4X Plastic | | 12 | | |
| UL general purpose amp rating | | Catalog number | List price | Catalog number | List price | |
| UL508 | | 16 | NF16P-3MB6A | \$ 860 | NF162-3MB6A | \$ 788 |
| | | 25 | NF25P-3MB6A | 870 | NF252-3MB6A | 798 |
| | | 40 | NF32P-3MB6A | 890 | NF322-3MB6A | 818 |
| UL98 | | 60 | NF45P-3MB6B | 990 | NF452-3MB6B | 908 |
| | | 80 | NF63P-3MB6A | 1,090 | NF632-3MB6A | 978 |
| | | 30 | NF30P-3MB6B | 1,900 | NF302-3MB6B | 1,830 |
| | | 60 | NF60P-3MB6B | 1,950 | NF602-3MB6B | 1,880 |
| | | 100 | NF100P-3MB6B | 2,000 | NF1002-3MB6B | 1,930 |
| | | 125 | NF125P-3MB8A | 6,000 | NF1252-6PB6A | 2,860 |
| | | 200 | NF200P-3MB8B | 8,350 | NF2002-3MB8B | 3,710 |
| | | 400 | NF400P-3MB4B | 12,360 | NF4002-3MB4B | 6,030 |
| | | 600 | NF600P-3MB4B | 20,360 | NF6002-3MB4B | 10,420 |
| | | 800 | NF800P-3MB4A | 32,360 | NF8002-3MB4A | 19,860 |
| 1200 | NF1200P-3MB4A | 38,360 | NF12002-3MB4A | 24,020 | | |

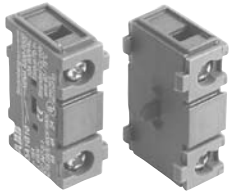

OA1G_

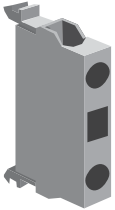

OBEA_

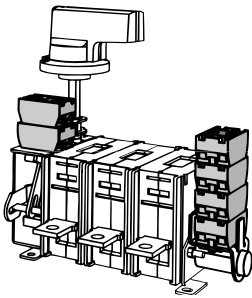

OZ XK_



3 Position selector switch



Pilot light

Auxiliary contacts

| For use on: | Contact configuration | Catalog number | Installation suffix | Installed list price adder |
|--------------|-----------------------|----------------|---------------------|----------------------------|
| 16A – 100A | 1 N.O. | OA1G10 | add "10" suffix | \$ 30 |
| | 1 N.C. | OA1G01 | add "01" suffix | 30 |
| | 1 N.O. & 1 N.C. | OA1G11 | add "11" suffix | 60 |
| 125A | 1 N.O. | OBEA-10 | add "10" suffix | 50 |
| | 1 N.C. | OBEA-01 | add "01" suffix | 50 |
| 200A – 600A | 1 N.O. | OA1G10 | add "10" suffix | 30 |
| | 1 N.C. | OA3G01 | add "01" suffix | 30 |
| 800A – 3150A | 1 N.O. & 1 N.C. | OZ XK-1 | add "11" suffix | 130 |
| | 2 N.O. & 2 N.C. | OZ XK-2 | add "22" suffix | 200 |

Accessories ①

| For use on: | Description | Installation suffix | Installed list price adder |
|---|----------------------------------|---------------------|----------------------------|
| OT16, 25,32 OT45, 63 OT30, 60, 100 OT160 | Neutral or isolated ground block | N or G | \$ 30 |
| | Neutral or isolated ground block | N or G | 54 |
| | Neutral or isolated ground block | N or G | 75 |
| | Neutral or isolated ground block | N or G | 150 |
| | Neutral block | N | 210 |
| 200A – 1200A 1600A – 3150A | Neutral block | N | 350 |
| | Neutral block | N | 350 |
| 30A – 1200A 30A – 1200A | Service entrance, 3 wire | U | 100 |
| | Service entrance, 4 wire | V | 200 |
| 16A – 3150A | Start/stop pushbuttons | A | 68 |
| | 2 position selector switch | C | 68 |
| | 3 position selector switch | D | 78 |
| | Pilot light "red/run" | E | 110 |
| | Ammeter 1 phase ② | AM | 940 |
| | Voltmeter ② | VM | 2300 |

① Please consult factory for special customer requirements.

② Current transformers included.

3 Pole 30A – 800A

Disconnect
switches
Fusible
Enclosed



FJ30X-3PB6B

3 Pole, 600V, 30A – 800A ①

NEMA Enclosure type

| UL general purpose amp rating | Fuse type | 1 | | 3R | | 4 | | 4X Stainless | | |
|-------------------------------------|--------------|-------------------|---------------|-------------------|---------------|-------------------|---------------|-------------------|---------------|----------|
| | | Catalog number | List price | Catalog number | List price | Catalog number | List price | Catalog number | List price | |
| | 30 | J | FJ301-3PB6B | | FJ303-3PB6B | \$ 600 | FJ304-3PB6B | \$ 1,100 | FJ30X-3PB6B | \$ 1,400 |
| | 30 | CC | FC301-3PB6B | \$ 560 | FC303-3PB6B | \$ 600 | FC304-3PB6B | \$ 1,100 | FC30X-3PB6B | \$ 1,400 |
| | 60 | J [®] | FJ601-3PB6B | 660 | FJ603-3PB6B | 860 | FJ604-3PB8B | 1,300 | FJ60X-3PB8B | 1,800 |
| | 100 | J [®] | FJ1001-3PB8B | 960 | FJ1003-3PB8B | 1,140 | FJ1004-3PB8B | 2,800 | FJ100X-3PB8B | 3,800 |
| | 200 | J [®] | FJ2001-3PB8C | 2,200 | FJ2003-3PB8C | 2,400 | FJ2004-3PB8C | 3,900 | FJ200X-3PB8C | 5,000 |
| | 400 | J [®] | FJ4001-3PB4C | 3,800 | FJ4003-3PB4C | 4,200 | FJ4004-3PB4C | 7,700 | FJ400X-3PB4B | 10,800 |
| | 600 | J [®] | FJ6001-3PB7C | 5,300 | FJ6003-3PB7C | 6,800 | FJ6004-3PB7C | 11,000 | FJ600X-3PB7C | 16,000 |
| | 800 | L | FL8001-3PB4B | 9,500 | FL8003-3PB4B | 11,200 | FL8004-3PB4B | 16,000 | FL800X-3PB4B | 21,000 |

3 Pole, 600V, 30A – 800A ①

NEMA Enclosure type

| UL general purpose amp rating | Fuse type | 4X Plastic | | 12 | | |
|-------------------------------------|--------------|-------------------|---------------|-------------------|---------------|--------|
| | | Catalog number | List price | Catalog number | List price | |
| | 30 | J | FJ30P-3PB6B | | FJ302-3PB6B | \$ 600 |
| | 30 | CC | FC30P-3PB6B | \$ 1,040 | FC302-3PB6B | \$ 600 |
| | 60 | J [®] | FJ60P-3PB8B | 1,300 | FJ602-3PB6B | 860 |
| | 100 | J [®] | FJ100P-3PB8B | 2,800 | FJ1002-3PB8B | 1,140 |
| | 200 | J [®] | FJ200P-3PB8C | 4,400 | FJ2002-3PB8C | 2,400 |
| | 400 | J [®] | FJ400P-3PB4C | 8,400 | FJ4002-3PB4C | 4,200 |
| | 600 | J [®] | FJ600P-3PB7C | 13,600 | FJ6002-3PB7C | 6,200 |
| | 800 | L | FL800P-3PB4B | 17,400 | FL8002-3PB4B | 9,800 |

NOTE: All enclosed switches are provided with a black handle; however, most handles can be substituted with a red / yellow handle if desired. Please substitute the handle suffix code (2nd and 3rd from last characters) with the red/yellow handle catalog number suffix from page 18.130. There is no additional price adder for changing to a red/yellow handle of equal ratings and style.

EXAMPLE: A red/yellow pistol handle for an FJ301-3PB6B can be substituted for the black pistol handle by using the "Y6" suffix instead of the "B6" suffix, new catalog number: FJ301-3PY6B.

① Fusible switches are UL listed to the UL98 standard.

Disconnect
switches
Fusible
Enclosed

2 & 4 Pole 30A – 800A

2 Pole, 600V, 30A – 800A

| UL general purpose amp rating | | Fuse type | NEMA Enclosure type | | | | | | | |
|---|-----|--------------|---------------------|---------------|-------------------|---------------|-------------------|---------------|-------------------|---------------|
| | | | 1 | | 3R | | 4 | | 4X Stainless | |
| | | | Catalog number | List price | Catalog number | List price | Catalog number | List price | Catalog number | List price |
|  | 30 | J | — | — | — | — | — | — | — | — |
| | 30 | CC | — | — | — | — | — | — | — | — |
| | 60 | J | — | — | — | — | — | — | — | — |
| | 100 | J | FJ1001-2PB8B | \$ 864 | FJ1003-2PB8B | \$ 1,026 | FJ1004-2PB8B | \$ 2,735 | FJ100X-2PB8B | \$ 3,420 |
| | 200 | J | FJ2001-2PB8C | 1,980 | FJ2003-2PB8C | 2,160 | FJ2004-2PB8C | 3,600 | FJ200X-2PB8C | 4,500 |
| | 400 | J | FJ4001-2PB4C | 3,420 | FJ4003-2PB4C | 3,780 | FJ4004-2PB4C | 7,775 | FJ400X-2PB4C | 9,720 |
| | 600 | J | FJ6001-2PB7C | 4,770 | FJ6003-2PB7C | 6,120 | FJ6004-2PB7C | 11,520 | FJ600X-2PB7C | 14,400 |
| | 800 | L | FL8001-2PB4B | 8,550 | FL8003-2PB4B | 10,080 | FL8004-2PB4B | 15,120 | FL800X-2PB4B | 18,900 |

| UL general purpose amp rating | | Fuse type | NEMA Enclosure type | | | |
|---|-----|--------------|---------------------|---------------|-------------------|---------------|
| | | | 4X Plastic | | 12 | |
| | | | Catalog number | List price | Catalog number | List price |
|  | 30 | J | — | — | — | — |
| | 30 | CC | — | — | — | — |
| | 60 | J | — | — | — | — |
| | 100 | J | FJ100P-2PB8B | \$ 2,520 | FJ1002-2PB8B | \$ 1,026 |
| | 200 | J | FJ200P-2PB8C | 3,960 | FJ2002-2PB8C | 2,160 |
| | 400 | J | FJ400P-2PB4C | 7,560 | FJ4002-2PB4C | 3,780 |
| | 600 | J | FJ600P-2PB7C | 12,240 | FJ6002-2PB7C | 5,580 |
| | 800 | L | FL800P-2PB4B | 15,660 | FL8002-2PB4B | 8,820 |

4 Pole, 600V, 30A – 800A

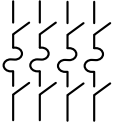
| UL general purpose amp rating | | Fuse type | NEMA Enclosure type | | | | | | | |
|---|-----|--------------|---------------------|---------------|-------------------|---------------|-------------------|---------------|-------------------|---------------|
| | | | 1 | | 3R | | 4 | | 4X Stainless | |
| | | | Catalog number | List price | Catalog number | List price | Catalog number | List price | Catalog number | List price |
|  | 30 | J | FJ301-4PB6B | \$ 700 | FJ303-4PB6B | \$ 750 | FJ304-4PB6B | \$ 1,375 | FJ30X-4PB6B | \$ 1,750 |
| | 30 | CC | FC301-4PB6B | | FC303-4PB6B | | FC304-4PB6B | | FC30X-4PB6B | |
| | 60 | J | FJ601-4PB6B | 825 | FJ603-4PB6B | 1,075 | FJ604-4PB8B | 1,800 | FJ60X-4PB8B | 2,250 |
| | 100 | J | FJ1001-4PB8B | 1,200 | FJ1003-4PB8B | 1,425 | FJ1004-4PB8B | 3,800 | FJ100X-4PB8B | 4,750 |
| | 200 | J | FJ2001-4PB8C | 2,750 | FJ2003-4PB8C | 3,000 | FJ2004-4PB8C | 5,000 | FJ200X-4PB8C | 6,250 |
| | 400 | J | FJ4001-4PB4C | 4,750 | FJ4003-4PB4C | 5,250 | FJ4004-4PB4C | 10,800 | FJ400X-4PB4C | 13,500 |
| | 600 | J | FJ6001-4PB7C | 6,625 | FJ6003-4PB7C | 8,500 | FJ6004-4PB7C | 16,000 | FJ600X-4PB7C | 20,000 |
| | 800 | L | FL8001-4PB4B | 11,875 | FL8003-4PB4B | 14,000 | FL8004-4PB4B | 21,000 | FL800X-4PB4B | 26,250 |

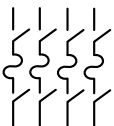
| UL general purpose amp rating | | Fuse type | NEMA Enclosure type | | | |
|---|-----|--------------|---------------------|---------------|-------------------|---------------|
| | | | 4X Plastic | | 12 | |
| | | | Catalog number | List price | Catalog number | List price |
|  | 30 | J | FJ30P-4PB6B | \$ 1,300 | FJ302-4PB6B | \$ 750 |
| | 30 | CC | FC30P-4PB6B | | FC302-4PB6B | |
| | 60 | J | FJ60P-4PB8B | 1,625 | FJ602-4PB6B | 1,075 |
| | 100 | J | FJ100P-4PB8B | 3,500 | FJ1002-4PB8B | 1,425 |
| | 200 | J | FJ200P-4PB8C | 5,500 | FJ2002-4PB8C | 3,000 |
| | 400 | J | FJ400P-4PB4C | 10,500 | FJ4002-4PB4C | 5,250 |
| | 600 | J | FJ600P-4PB7C | 17,000 | FJ6002-4PB7C | 7,750 |
| | 800 | L | FL800P-4PB4B | 21,750 | FL8002-4PB4B | 12,250 |



OESA-ZX157

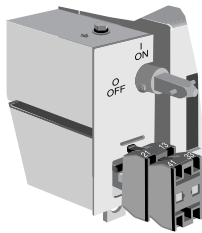

OZXK-1
OZXK-2



3 Position selection switch



Pilot light

Auxiliary contacts

| For use on: | Contact configuration | Catalog number | Installation suffix | Installed list price adder |
|-------------|-------------------------------------|------------------|------------------------------------|----------------------------|
| 30A | 1 N.O. + 1 N. C. 2 N.O. + 2 N.C. | OA4B1C | add "11" suffix add "22" suffix | \$ 40 40 |
| 60A – 600A | 1 N.O. 1 N.C. | OA1G10 OA3G01 | add "10" suffix add "01" suffix | 20 |
| 800A | 1 N.O. & 1 N.C. 2 N.O. & 2 N.C. | OZXK-1 OZXK-2 | add "11" suffix add "22" suffix | 100 170 |

Accessories ①②

| For use on: | Description | Installation suffix | Installed list price adder |
|-------------|---|------------------------------|--------------------------------------|
| 30A | Neutral block | N | \$ 40 |
| 60A – 100A | Neutral block | N | 50 |
| 200A – 400A | Neutral block | N | 150 |
| 600A – 800A | Neutral block | N | 160 |
| 30A – 200A | Service entrance, 3 wire Service entrance, 4 wire | U V | 75 125 |
| 400A – 800A | Service entrance, 3 wire Service entrance, 4 wire | U V | 150 200 |
| 30A – 800A | Start/stop pushbuttons 2 position selector switch 3 position selector switch Pilot light "red/run" Ammeter 1 phase ③ Voltmeter ③ | A C D E AM VM | 68 68 78 110 940 2300 |

① Additional accessories can be found on pages 18.83 – 18.95.

② Please consult factory for special customer requirements.

③ Current transformers included.