

LM2931-N Series Low Dropout Regulators

Check for Samples: [LM2931-N](#)

FEATURES

- Very Low Quiescent Current
- Output Current in Excess of 100 mA
- Input-output Differential Less than 0.6V
- Reverse Battery Protection
- 60V Load Dump Protection
- –50V Reverse Transient Protection
- Short Circuit Protection
- Internal Thermal Overload Protection
- Mirror-image Insertion Protection
- Available in TO-220, TO-92, TO-263, or SOIC-8 Packages
- Available as Adjustable with TTL Compatible Switch

DESCRIPTION

The LM2931-N positive voltage regulator features a very low quiescent current of 1mA or less when supplying 10mA loads. This unique characteristic and the extremely low input-output differential required for proper regulation (0.2V for output currents of 10mA) make the LM2931-N the ideal regulator for standby power systems. Applications include memory standby circuits, CMOS and other low power processor power supplies as well as systems demanding as much as 100mA of output current.

Designed originally for automotive applications, the LM2931-N and all regulated circuitry are protected from reverse battery installations or 2 battery jumps. During line transients, such as a load dump (60V) when the input voltage to the regulator can momentarily exceed the specified maximum operating voltage, the regulator will automatically shut down to protect both internal circuits and the load. The LM2931-N cannot be harmed by temporary mirror-image insertion. Familiar regulator features such as short circuit and thermal overload protection are also provided.

The LM2931-N family includes a fixed 5V output ($\pm 3.8\%$ tolerance for A grade) or an adjustable output with ON/OFF pin. Both versions are available in a TO-220 power package, DDPK/TO-263 surface mount package, and an 8-lead SOIC package. The fixed output version is also available in the TO-92 plastic package.

Connection Diagrams

FIXED VOLTAGE OUTPUT

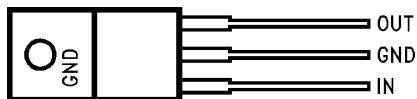

Figure 1. TO-220 3-Lead Power Package Front View

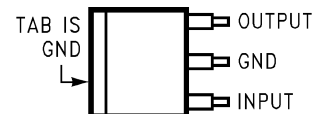

Figure 2. DDPK/TO-263 Surface-Mount Package Top View

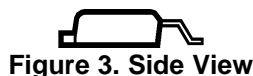
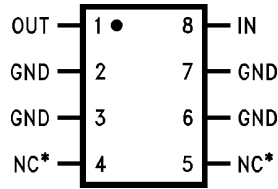

Figure 3. Side View



Please be aware that an important notice concerning availability, standard warranty, and use in critical applications of Texas Instruments semiconductor products and disclaimers thereto appears at the end of this data sheet.

All trademarks are the property of their respective owners.



*NC = Not internally connected. Must be electrically isolated from the rest of the circuit for the DSBGA package.

**Figure 4. 8-Pin SOIC
Top View**

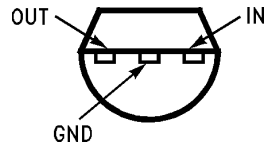

**Figure 5. TO-92 Plastic Package
Bottom View**

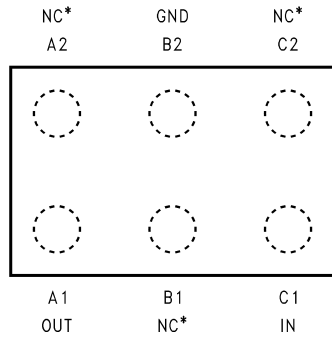

**Figure 6. 6-Bump DSBGA
Top View
(Bump Side Down)**

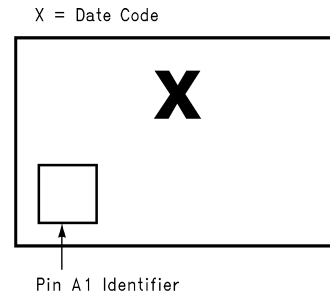
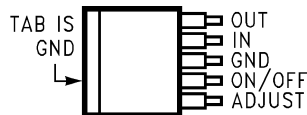

Figure 7. DSBGA Laser Mark

ADJUSTABLE OUTPUT VOLTAGE



**Figure 8. TO-220 5-Lead Power Package
Front View**



**Figure 9. DDPAK/TO-263
5-Lead Surface-Mount Package
Top View**



Figure 10. Side View

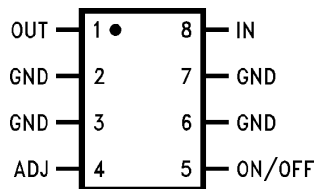
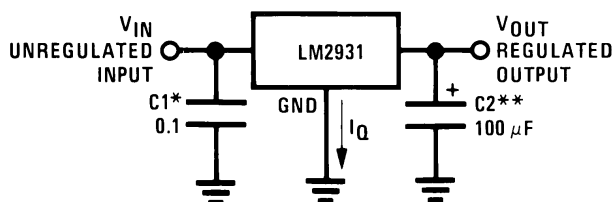

Figure 11. 8-Pin SOIC Top View

Typical Applications



*Required if regulator is located far from power supply filter.

**C2 must be at least 100 μF to maintain stability. May be increased without bound to maintain regulation during transients. Locate as close as possible to the regulator. This capacitor must be rated over the same operating temperature range as the regulator. The equivalent series resistance (ESR) of this capacitor is critical; see curve.

Figure 12. LM2931-N Fixed Output

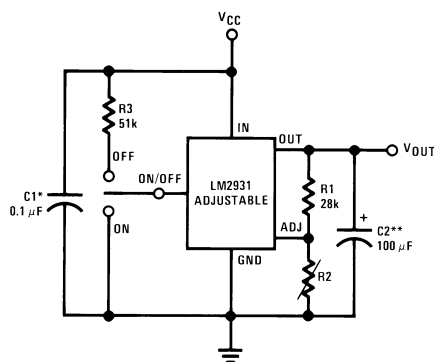

$$V_{OUT} = \text{Reference Voltage} \times \frac{R1 + R2}{R1}$$

Note: Using 27k for R1 will automatically compensate for errors in V_{OUT} due to the input bias current of the ADJ pin (approximately 1 μA).

Figure 13. LM2931-N Adjustable Output



These devices have limited built-in ESD protection. The leads should be shorted together or the device placed in conductive foam during storage or handling to prevent electrostatic damage to the MOS gates.

ABSOLUTE MAXIMUM RATINGS⁽¹⁾⁽²⁾

Input Voltage	
Operating Range	26V
Overvoltage Protection	
LM2931A, LM2931C (Adjustable)	60V
LM2931-N	50V
Internal Power Dissipation	
(3) (4)	Internally Limited
Operating Ambient Temperature	
Range	-40°C to +85°C
Maximum Junction Temperature	125°C
Storage Temperature Range	-65°C to +150°C
Lead Temp. (Soldering, 10 seconds)	230°C
ESD Tolerance ⁽⁵⁾	2000V

- (1) Absolute Maximum Ratings indicate limits beyond which damage to the device may occur. Electrical specifications do not apply when operating the device beyond its rated operating conditions.
- (2) If Military/Aerospace specified devices are required, please contact the Texas Instruments Sales Office/Distributors for availability and specifications.
- (3) See circuit in [Typical Applications](#). To ensure constant junction temperature, low duty cycle pulse testing is used.
- (4) The maximum power dissipation is a function of maximum junction temperature T_{Jmax} , total thermal resistance θ_{JA} , and ambient temperature T_A . The maximum allowable power dissipation at any ambient temperature is $P_D = (T_{Jmax} - T_A)/\theta_{JA}$. If this dissipation is exceeded, the die temperature will rise above 150°C and the LM2931-N will go into thermal shutdown. For the LM2931-N in the TO-92 package, θ_{JA} is 195°C/W; in the SOIC-8 package, θ_{JA} is 160°C/W, and in the TO-220 package, θ_{JA} is 50°C/W; in the DPAK/TO-263 package, θ_{JA} is 73°C/W; and in the 6-Bump DSBGA package θ_{JA} is 290°C/W. If the TO-220 package is used with a heat sink, θ_{JA} is the sum of the package thermal resistance junction-to-case of 3°C/W and the thermal resistance added by the heat sink and thermal interface. If the TO-263 package is used, the thermal resistance can be reduced by increasing the P.C. board copper area thermally connected to the package: Using 0.5 square inches of copper area, θ_{JA} is 50°C/W; with 1 square inch of copper area, θ_{JA} is 37°C/W; and with 1.6 or more square inches of copper area, θ_{JA} is 32°C/W.
- (5) Human body model, 100 pF discharged through 1.5 kΩ.

ELECTRICAL CHARACTERISTICS FOR FIXED 3.3V VERSION

$V_{IN} = 14V$, $I_O = 10mA$, $T_J = 25^\circ C$, $C_2 = 100\mu F$ (unless otherwise specified)⁽¹⁾

Parameter	Conditions	LM2931-N-3.3		Units
		Typ	Limit ⁽²⁾	
Output Voltage		3.3	3.465 3.135	V_{MAX} V_{MIN}
	$4V \leq V_{IN} \leq 26V$, $I_O = 100mA$ $-40^\circ C \leq T_J \leq 125^\circ C$		3.630 2.970	V_{MAX} V_{MIN}
Line Regulation	$4V \leq V_{IN} \leq 26V$	4	33	mV_{MAX}
Load Regulation	$5mA \leq I_O \leq 100mA$	10	50	mV_{MAX}
Output Impedance	$100mA_{DC}$ and $10mA_{rms}$, 100Hz - 10kHz	200		$m\Omega$
Quiescent Current	$I_O \leq 10mA$, $4V \leq V_{IN} \leq 26V$ $-40^\circ C \leq T_J \leq 125^\circ C$	0.4	1.0	mA_{MAX}
	$I_O = 100mA$, $V_{IN} = 14V$, $T_J = 25^\circ C$	15		mA
Output Noise Voltage	10Hz -100kHz, $C_{OUT} = 100\mu F$	330		μV_{rms}
Long Term Stability		13		$mV/1000\text{ hr}$
Ripple Rejection	$f_O = 120Hz$	80		dB

- (1) See circuit in [Typical Applications](#). To ensure constant junction temperature, low duty cycle pulse testing is used.
- (2) All limits are specified for $T_J = 25^\circ C$ (standard type face) or over the full operating junction temperature range of $-40^\circ C$ to $+125^\circ C$ (bold type face).

ELECTRICAL CHARACTERISTICS FOR FIXED 3.3V VERSION (continued)
 $V_{IN} = 14V$, $I_O = 10mA$, $T_J = 25^\circ C$, $C_2 = 100\mu F$ (unless otherwise specified) ⁽¹⁾

Parameter	Conditions	LM2931-N-3.3		Units
		Typ	Limit (2)	
Dropout Voltage	$I_O = 10mA$ $I_O = 100mA$	0.05 0.30	0.2 0.6	V_{MAX}
Maximum Operational Input Voltage		33	26	V_{MIN}
Maximum Line Transient	$R_L = 500\Omega$, $V_O \leq 5.5V$, $T = 1ms$, $\tau \leq 100ms$	70	50	V_{MIN}
Reverse Polarity Input Voltage, DC	$V_O \geq -0.3V$, $R_L = 500\Omega$	-30	-15	V_{MIN}
Reverse Polarity Input Voltage, Transient	$T = 1ms$, $\tau \leq 100ms$, $R_L = 500\Omega$	-80	-50	V_{MIN}

ELECTRICAL CHARACTERISTICS FOR FIXED 5V VERSION
 $V_{IN} = 14V$, $I_O = 10mA$, $T_J = 25^\circ C$, $C_2 = 100\mu F$ (unless otherwise specified) ⁽¹⁾

Parameter	Conditions	LM2931A-5.0		LM2931-N-5.0		Units
		Typ	Limit (2)	Typ	Limit (2)	
Output Voltage		5	5.19 4.81	5	5.25 4.75	V_{MAX} V_{MIN}
	$6.0V \leq V_{IN} \leq 26V$, $I_O = 100mA$ $-40^\circ C \leq T_J \leq 125^\circ C$		5.25 4.75		5.5 4.5	V_{MAX} V_{MIN}
Line Regulation	$9V \leq V_{IN} \leq 16V$	2	10	2	10	mV_{MAX}
	$6V \leq V_{IN} \leq 26V$	4	30	4	30	
Load Regulation	$5mA \leq I_O \leq 100mA$	14	50	14	50	mV_{MAX}
Output Impedance	$100mA_{DC}$ and $10mA_{rms}$, 100Hz -10kHz	200		200		$m\Omega$
Quiescent Current	$I_O \leq 10mA$, $6V \leq V_{IN} \leq 26V$ $-40^\circ C \leq T_J \leq 125^\circ C$	0.4	1.0	0.4	1.0	mA_{MAX}
	$I_O = 100mA$, $V_{IN} = 14V$, $T_J = 25^\circ C$	15	30	15		mA_{MAX}
Output Noise Voltage	10Hz -100kHz, $C_{OUT} = 100\mu F$	500		500		μV_{rms}
Long Term Stability		20		20		$mV/1000$ hr
Ripple Rejection	$f_O = 120Hz$	80	55	80		dB_{MIN}
Dropout Voltage	$I_O = 10mA$	0.05	0.2	0.05	0.2	V_{MAX}
	$I_O = 100mA$	0.3	0.6	0.3	0.6	
Maximum Operational Input Voltage		33	26	33	26	V_{MIN}
Maximum Line Transient	$R_L = 500\Omega$, $V_O \leq 5.5V$, $T = 1ms$, $\tau \leq 100ms$	70	60	70	50	V_{MIN}
Reverse Polarity Input Voltage, DC	$V_O \geq -0.3V$, $R_L = 500\Omega$	-30	-15	-30	-15	V_{MIN}
Reverse Polarity Input Voltage, Transient	$T = 1ms$, $\tau \leq 100ms$, $R_L = 500\Omega$	-80	-50	-80	-50	V_{MIN}

(1) See circuit in [Typical Applications](#). To ensure constant junction temperature, low duty cycle pulse testing is used.

(2) All limits are specified for $T_J = 25^\circ C$ (standard type face) or over the full operating junction temperature range of $-40^\circ C$ to $+125^\circ C$ (bold type face).

ELECTRICAL CHARACTERISTICS FOR ADJUSTABLE VERSION
 $V_{IN} = 14V$, $V_{OUT} = 3V$, $I_O = 10\text{ mA}$, $T_J = 25^\circ\text{C}$, $R1 = 27k$, $C2 = 100\ \mu\text{F}$ (unless otherwise specified) ⁽¹⁾

Parameter	Conditions	Typ	Limit	Units Limit
Reference Voltage	$I_O \leq 100\text{ mA}$, $-40^\circ\text{C} \leq T_J \leq 125^\circ\text{C}$, $R1 = 27k$ Measured from V_{OUT} to Adjust Pin	1.20	1.26	V_{MAX}
			1.14	V_{MIN}
			1.32	V_{MAX}
			1.08	V_{MIN}
Output Voltage Range			24	V_{MAX}
			3	V_{MIN}
Line Regulation	$V_{OUT} + 0.6V \leq V_{IN} \leq 26V$	0.2	1.5	mV/V_{MAX}
Load Regulation	$5\text{ mA} \leq I_O \leq 100\text{ mA}$	0.3	1	$\%_{MAX}$
Output Impedance	100 mA_{DC} and 10 mA_{rms} , 100 Hz–10 kHz	40		$\text{m}\Omega/V$
Quiescent Current	$I_O = 10\text{ mA}$ $I_O = 100\text{ mA}$ During Shutdown $R_L = 500\Omega$	0.4 15 0.8	1 1 1	mA_{MAX}
				mA
				mA_{MAX}
Output Noise Voltage	10 Hz–100 kHz	100		$\mu\text{V}_{rms}/V$
Long Term Stability		0.4		$\%/1000\text{ hr}$
Ripple Rejection	$f_O = 120\text{ Hz}$	0.02		$\%/V$
Dropout Voltage	$I_O \leq 10\text{ mA}$ $I_O = 100\text{ mA}$	0.05 0.3	0.2	V_{MAX}
			0.6	V_{MAX}
Maximum Operational Input Voltage		33	26	V_{MIN}
Maximum Line Transient	$I_O = 10\text{ mA}$, Reference Voltage $\leq 1.5V$ $T = 1\text{ ms}$, $\tau \leq 100\text{ ms}$	70	60	V_{MIN}
Reverse Polarity Input Voltage, DC	$V_O \geq -0.3V$, $R_L = 500\Omega$	-30	-15	V_{MIN}
Reverse Polarity Input Voltage, Transient	$T = 1\text{ ms}$, $\tau \leq 100\text{ ms}$, $R_L = 500\Omega$	-80	-50	V_{MIN}
On/Off Threshold Voltage	$V_O = 3V$			V_{MAX}
				V_{MIN}
On/Off Threshold Current		20	50	μA_{MAX}

(1) See circuit in [Typical Applications](#). To ensure constant junction temperature, low duty cycle pulse testing is used.

TYPICAL PERFORMANCE CHARACTERISTICS

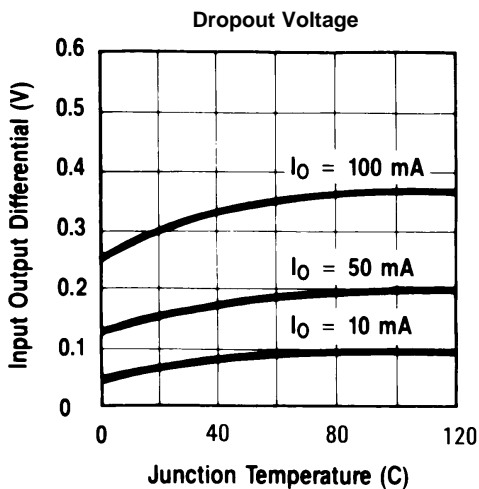

Figure 14.

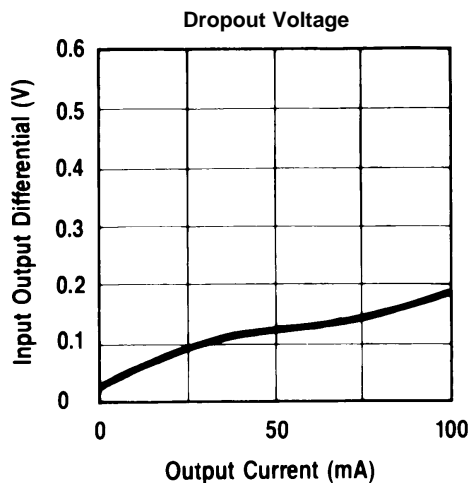

Figure 15.

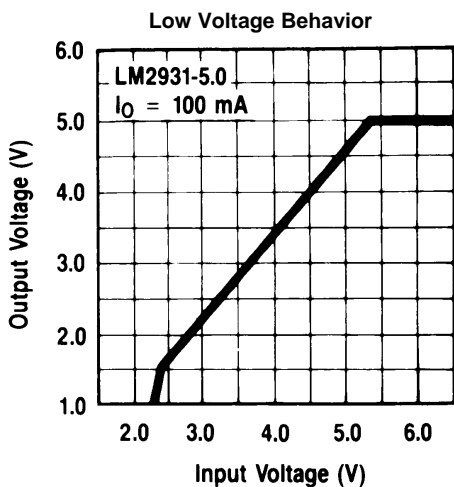

Figure 16.

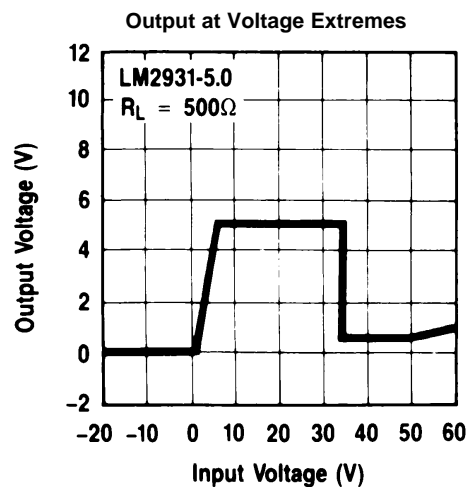

Figure 17.

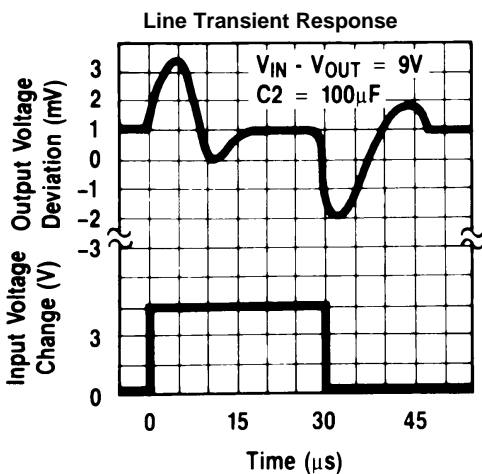

Figure 18.

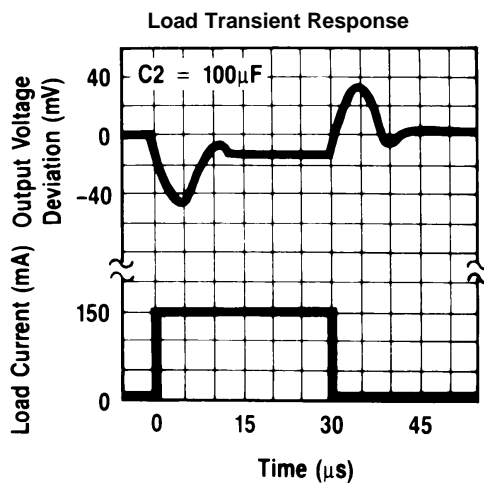

Figure 19.

TYPICAL PERFORMANCE CHARACTERISTICS (continued)

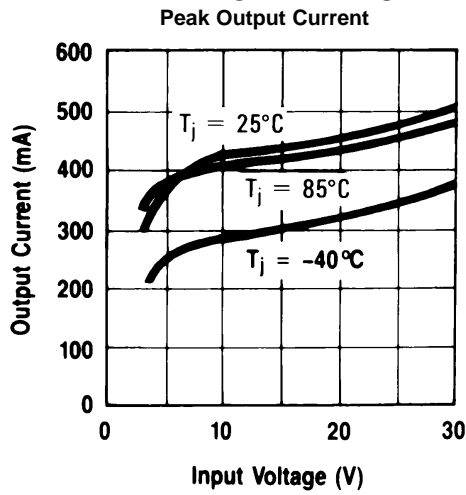

Figure 20.

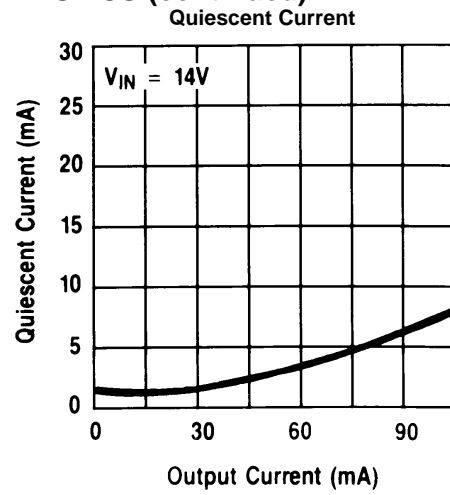

Figure 21.

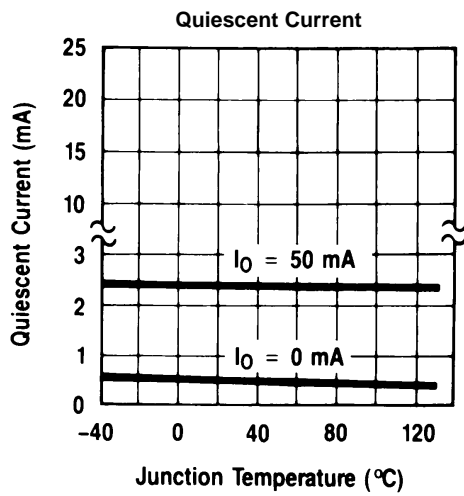

Figure 22.

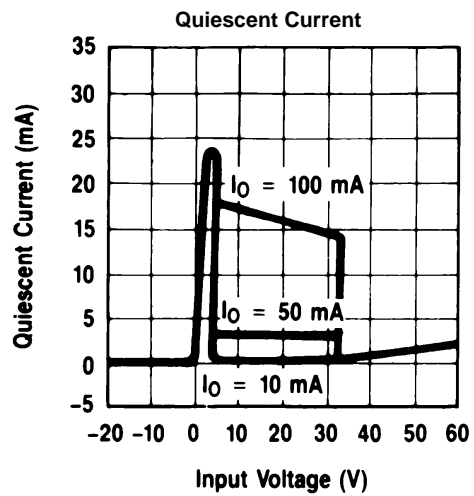

Figure 23.

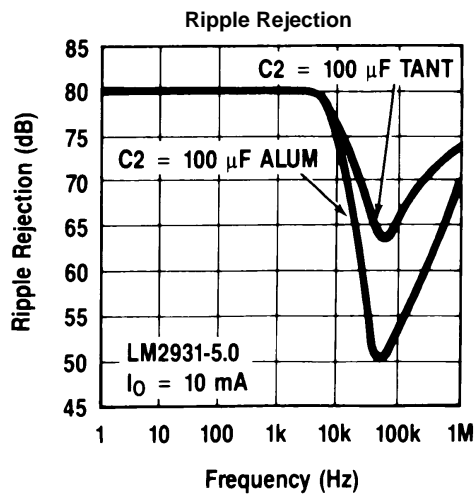

Figure 24.

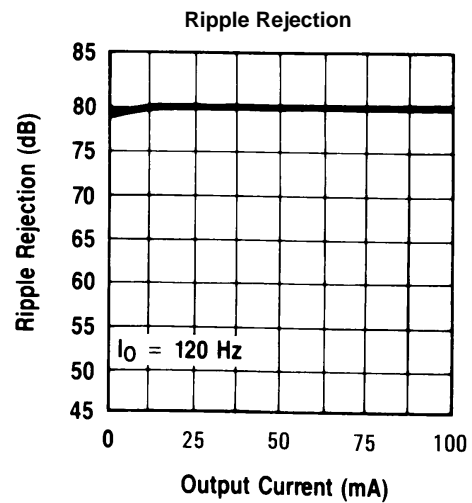

Figure 25.

TYPICAL PERFORMANCE CHARACTERISTICS (continued)

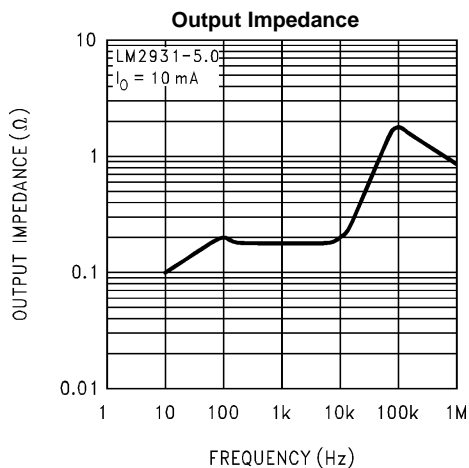

Figure 26.

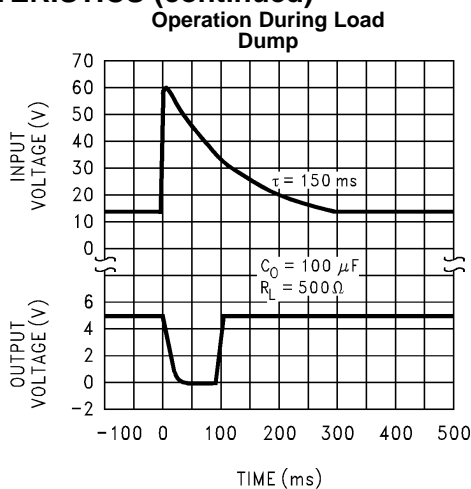

Figure 27.

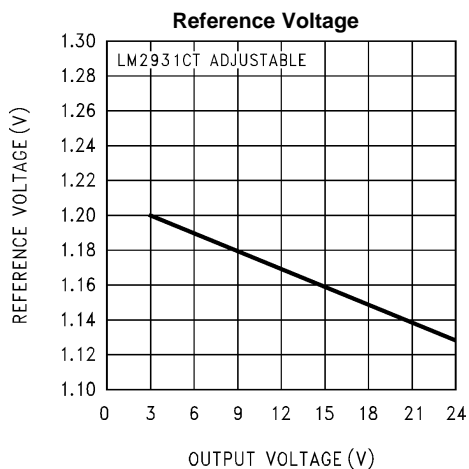

Figure 28.

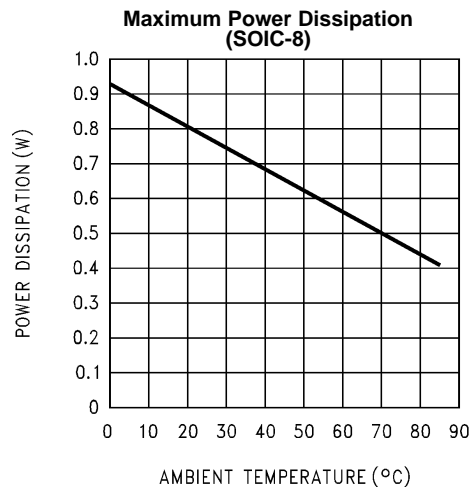

Figure 29.

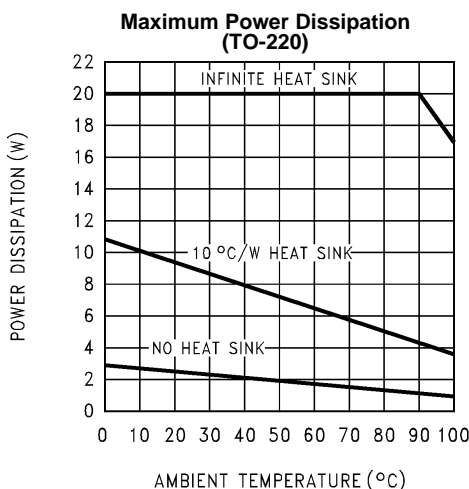

Figure 30.

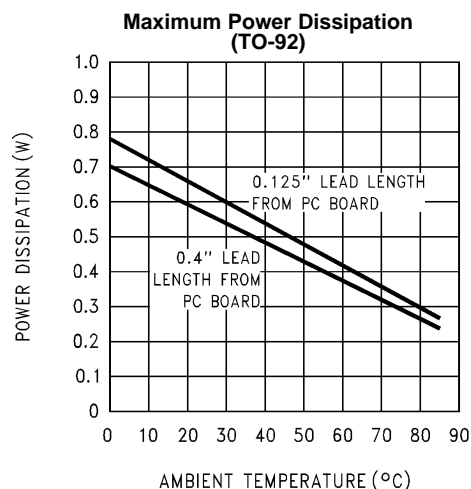

Figure 31.

TYPICAL PERFORMANCE CHARACTERISTICS (continued)

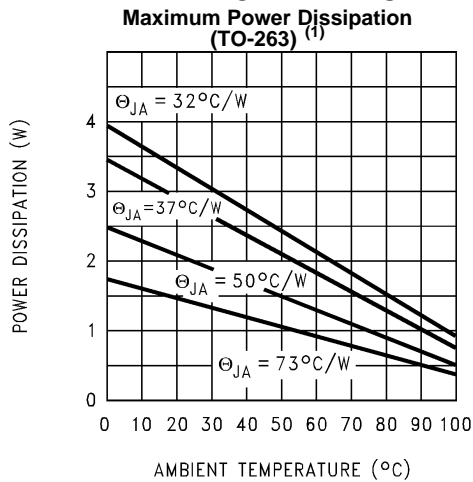

Figure 32.

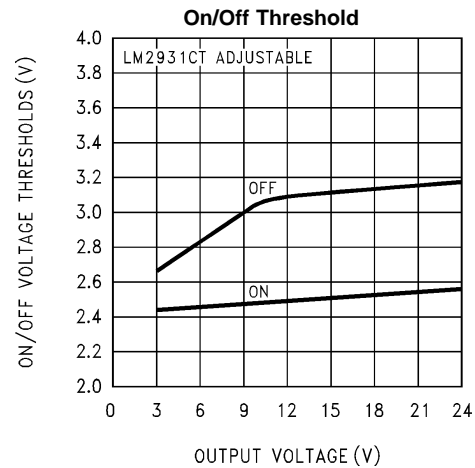

Figure 33.

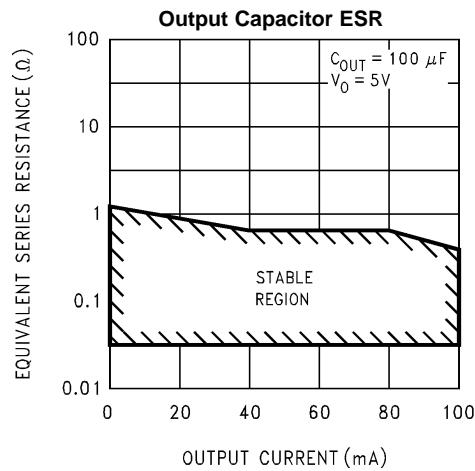
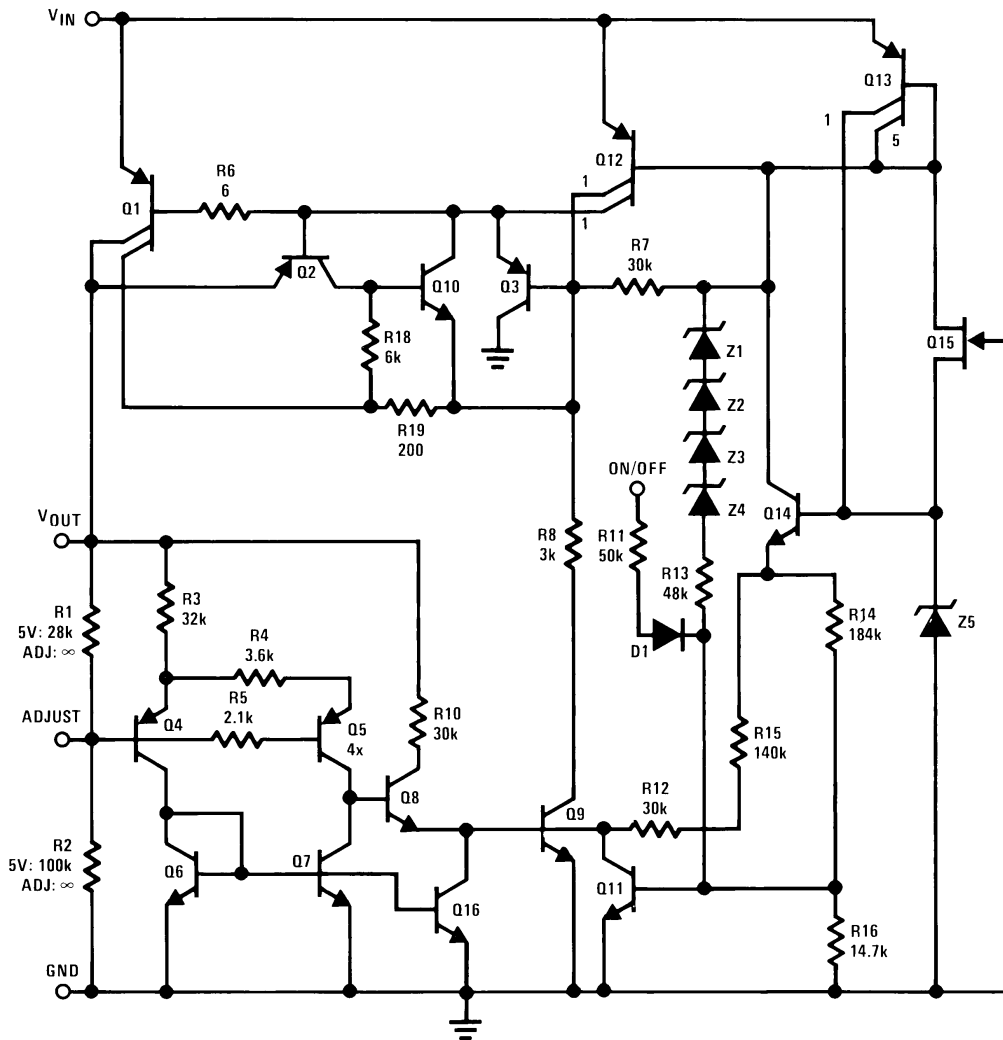

Figure 34.

- (1) The maximum power dissipation is a function of maximum junction temperature T_{Jmax} , total thermal resistance θ_{JA} , and ambient temperature T_A . The maximum allowable power dissipation at any ambient temperature is $P_D = (T_{Jmax} - T_A)/\theta_{JA}$. If this dissipation is exceeded, the die temperature will rise above 150°C and the LM2931-N will go into thermal shutdown. For the LM2931-N in the TO-92 package, θ_{JA} is 195°C/W; in the SOIC-8 package, θ_{JA} is 160°C/W, and in the TO-220 package, θ_{JA} is 50°C/W; in the DDPAK/TO-263 package, θ_{JA} is 73°C/W; and in the 6-Bump DSBGA package θ_{JA} is 290°C/W. If the TO-220 package is used with a heat sink, θ_{JA} is the sum of the package thermal resistance junction-to-case of 3°C/W and the thermal resistance added by the heat sink and thermal interface. If the TO-263 package is used, the thermal resistance can be reduced by increasing the P.C. board copper area thermally connected to the package: Using 0.5 square inches of copper area, θ_{JA} is 50°C/W; with 1 square inch of copper area, θ_{JA} is 37°C/W; and with 1.6 or more square inches of copper area, θ_{JA} is 32°C/W.

SCHEMATIC DIAGRAM



APPLICATION HINTS

One of the distinguishing factors of the LM2931-N series regulators is the requirement of an output capacitor for device stability. The value required varies greatly depending upon the application circuit and other factors. Thus some comments on the characteristics of both capacitors and the regulator are in order.

High frequency characteristics of electrolytic capacitors depend greatly on the type and even the manufacturer. As a result, a value of capacitance that works well with the LM2931-N for one brand or type may not necessary be sufficient with an electrolytic of different origin. Sometimes actual bench testing, as described later, will be the only means to determine the proper capacitor type and value. Experience has shown that, as a rule of thumb, the more expensive and higher quality electrolytics generally allow a smaller value for regulator stability. As an example, while a high-quality 100 μF aluminum electrolytic covers all general application circuits, similar stability can be obtained with a tantalum electrolytic of only 47 μF . This factor of two can generally be applied to any special application circuit also.

Another critical characteristic of electrolytics is their performance over temperature. While the LM2931-N is designed to operate to -40°C , the same is not always true with all electrolytics (hot is generally not a problem). The electrolyte in many aluminum types will freeze around -30°C , reducing their effective value to zero. Since the capacitance is needed for regulator stability, the natural result is oscillation (and lots of it) at the regulator output. For all application circuits where cold operation is necessary, the output capacitor must be rated to operate at the minimum temperature. By coincidence, worst-case stability for the LM2931-N also occurs at minimum temperatures. As a result, in applications where the regulator junction temperature will never be less than 25°C , the output capacitor can be reduced approximately by a factor of two over the value needed for the entire temperature range. To continue our example with the tantalum electrolytic, a value of only 22 μF would probably thus suffice. For high-quality aluminum, 47 μF would be adequate in such an application.

Another regulator characteristic that is noteworthy is that stability decreases with higher output currents. This sensible fact has important connotations. In many applications, the LM2931-N is operated at only a few milliamps of output current or less. In such a circuit, the output capacitor can be further reduced in value. As a rough estimation, a circuit that is required to deliver a maximum of 10mA of output current from the regulator would need an output capacitor of only half the value compared to the same regulator required to deliver the full output current of 100mA. If the example of the tantalum capacitor in the circuit rated at 25°C junction temperature and above were continued to include a maximum of 10mA of output current, then the 22 μF output capacitor could be reduced to only 10 μF .

In the case of the LM2931CT adjustable regulator, the minimum value of output capacitance is a function of the output voltage. As a general rule, the value decreases with higher output voltages, since internal loop gain is reduced.

At this point, the procedure for bench testing the minimum value of an output capacitor in a special application circuit should be clear. Since worst-case occurs at minimum operating temperatures and maximum operating currents, the entire circuit, including the electrolytic, should be cooled to the minimum temperature. The input voltage to the regulator should be maintained at 0.6V above the output to keep internal power dissipation and die heating to a minimum. Worst-case occurs just after input power is applied and before the die has had a chance to heat up. Once the minimum value of capacitance has been found for the brand and type of electrolytic in question, the value should be doubled for actual use to account for production variations both in the capacitor and the regulator. (All the values in this section and the remainder of the data sheet were determined in this fashion.)

LM2931-N DSBGA Light Sensitivity

When the LM2931-N DSBGA package is exposed to bright sunlight, normal office fluorescent light, and other LED's, it operates within the limits specified in the electrical characteristic table.

Definition of Terms

Dropout Voltage: The input-output voltage differential at which the circuit ceases to regulate against further reduction in input voltage. Measured when the output voltage has dropped 100 mV from the nominal value obtained at 14V input, dropout voltage is dependent upon load current and junction temperature.

Input Voltage: The DC voltage applied to the input terminals with respect to ground.

Input-Output Differential: The voltage difference between the unregulated input voltage and the regulated output voltage for which the regulator will operate.

Line Regulation: The change in output voltage for a change in the input voltage. The measurement is made under conditions of low dissipation or by using pulse techniques such that the average chip temperature is not significantly affected.

Load Regulation: The change in output voltage for a change in load current at constant chip temperature.

Long Term Stability: Output voltage stability under accelerated life-test conditions after 1000 hours with maximum rated voltage and junction temperature.

Output Noise Voltage: The rms AC voltage at the output, with constant load and no input ripple, measured over a specified frequency range.

Quiescent Current: That part of the positive input current that does not contribute to the positive load current. The regulator ground lead current.

Ripple Rejection: The ratio of the peak-to-peak input ripple voltage to the peak-to-peak output ripple voltage at a specified frequency.

Temperature Stability of V_O : The percentage change in output voltage for a thermal variation from room temperature to either temperature extreme.

REVISION HISTORY

Changes from Revision F (April 2013) to Revision G	Page
• Changed layout of National Data Sheet to TI format	13

PACKAGING INFORMATION

Orderable Device	Status (1)	Package Type	Package Drawing	Pins	Package Qty	Eco Plan (2)	Lead finish/ Ball material (6)	MSL Peak Temp (3)	Op Temp (°C)	Device Marking (4/5)	Samples
LM2931AM-5.0	NRND	SOIC	D	8	95	Non-RoHS & Green	Call TI	Call TI	-40 to 85	2931A M-5.0	
LM2931AM-5.0/NOPB	ACTIVE	SOIC	D	8	95	RoHS & Green	SN	Level-1-260C-UNLIM	-40 to 85	2931A M-5.0	Samples
LM2931AMX-5.0/NOPB	ACTIVE	SOIC	D	8	2500	RoHS & Green	SN	Level-1-260C-UNLIM	-40 to 85	2931A M-5.0	Samples
LM2931AS-5.0	NRND	DDPAK/ TO-263	KTT	3	45	Non-RoHS & Green	Call TI	Call TI	-40 to 85	LM2931 AS5.0	
LM2931AS-5.0/NOPB	ACTIVE	DDPAK/ TO-263	KTT	3	45	RoHS-Exempt & Green	SN	Level-3-245C-168 HR	-40 to 85	LM2931 AS5.0	Samples
LM2931ASX-5.0	NRND	DDPAK/ TO-263	KTT	3	500	Non-RoHS & Green	Call TI	Call TI	-40 to 85	LM2931 AS5.0	
LM2931ASX-5.0/NOPB	ACTIVE	DDPAK/ TO-263	KTT	3	500	RoHS-Exempt & Green	SN	Level-3-245C-168 HR	-40 to 85	LM2931 AS5.0	Samples
LM2931AT-5.0	NRND	TO-220	NDE	3	45	Non-RoHS & Green	Call TI	Call TI	-40 to 85	LM2931 AT5.0	
LM2931AT-5.0/NOPB	ACTIVE	TO-220	NDE	3	45	RoHS & Green	SN	Level-1-NA-UNLIM	-40 to 85	LM2931 AT5.0	Samples
LM2931AZ-5.0/LFT1	ACTIVE	TO-92	LP	3	2000	RoHS & Green	SN	N / A for Pkg Type	-40 to 85	LM293 1AZ-5	Samples
LM2931AZ-5.0/LFT3	ACTIVE	TO-92	LP	3	2000	RoHS & Green	SN	N / A for Pkg Type	-40 to 85	LM293 1AZ-5	Samples
LM2931AZ-5.0/LFT4	ACTIVE	TO-92	LP	3	2000	RoHS & Green	SN	N / A for Pkg Type	-40 to 85	LM293 1AZ-5	Samples
LM2931AZ-5.0/NOPB	ACTIVE	TO-92	LP	3	1800	RoHS & Green	SN	N / A for Pkg Type	-40 to 85	LM293 1AZ-5	Samples
LM2931CM	NRND	SOIC	D	8	95	Non-RoHS & Green	Call TI	Call TI	-40 to 85	LM29 31CM	
LM2931CM/NOPB	ACTIVE	SOIC	D	8	95	RoHS & Green	SN	Level-1-260C-UNLIM	-40 to 85	LM29 31CM	Samples
LM2931CMX	NRND	SOIC	D	8	2500	Non-RoHS & Green	Call TI	Call TI	-40 to 85	LM29 31CM	
LM2931CMX/NOPB	ACTIVE	SOIC	D	8	2500	RoHS & Green	SN	Level-1-260C-UNLIM	-40 to 85	LM29	Samples

Orderable Device	Status (1)	Package Type	Package Drawing	Pins	Package Qty	Eco Plan (2)	Lead finish/ Ball material (6)	MSL Peak Temp (3)	Op Temp (°C)	Device Marking (4/5)	Samples
										31CM	
LM2931CS	NRND	DDPAK/ TO-263	KTT	5	45	Non-RoHS & Green	Call TI	Call TI	-40 to 85	LM2931CS	
LM2931CS/NOPB	ACTIVE	DDPAK/ TO-263	KTT	5	45	RoHS-Exempt & Green	SN	Level-3-245C-168 HR	-40 to 85	LM2931CS	Samples
LM2931CT/NOPB	ACTIVE	TO-220	KC	5	45	RoHS & Green	SN	Level-1-NA-UNLIM	-40 to 85	LM2931CT	Samples
LM2931M-5.0	NRND	SOIC	D	8	95	Non-RoHS & Green	Call TI	Call TI	-40 to 85	2931 M-5.0	
LM2931M-5.0/NOPB	ACTIVE	SOIC	D	8	95	RoHS & Green	SN	Level-1-260C-UNLIM	-40 to 85	2931 M-5.0	Samples
LM2931MX-5.0	NRND	SOIC	D	8	2500	Non-RoHS & Green	Call TI	Call TI	-40 to 85	2931 M-5.0	
LM2931MX-5.0/NOPB	ACTIVE	SOIC	D	8	2500	RoHS & Green	SN	Level-1-260C-UNLIM	-40 to 85	2931 M-5.0	Samples
LM2931S-5.0/NOPB	ACTIVE	DDPAK/ TO-263	KTT	3	45	RoHS-Exempt & Green	SN	Level-3-245C-168 HR	-40 to 85	LM2931S 5.0	Samples
LM2931T-5.0/NOPB	ACTIVE	TO-220	NDE	3	45	RoHS & Green	SN	Level-1-NA-UNLIM	-40 to 85	LM2931T 5.0	Samples
LM2931Z-5.0/LFT2	ACTIVE	TO-92	LP	3	2000	RoHS & Green	SN	N / A for Pkg Type	-40 to 85	LM293 1Z-5	Samples
LM2931Z-5.0/NOPB	ACTIVE	TO-92	LP	3	1800	RoHS & Green	SN	N / A for Pkg Type	-40 to 85	LM293 1Z-5	Samples

(1) The marketing status values are defined as follows:

ACTIVE: Product device recommended for new designs.

LIFEBUY: TI has announced that the device will be discontinued, and a lifetime-buy period is in effect.

NRND: Not recommended for new designs. Device is in production to support existing customers, but TI does not recommend using this part in a new design.

PREVIEW: Device has been announced but is not in production. Samples may or may not be available.

OBsolete: TI has discontinued the production of the device.

(2) **RoHS:** TI defines "RoHS" to mean semiconductor products that are compliant with the current EU RoHS requirements for all 10 RoHS substances, including the requirement that RoHS substance do not exceed 0.1% by weight in homogeneous materials. Where designed to be soldered at high temperatures, "RoHS" products are suitable for use in specified lead-free processes. TI may reference these types of products as "Pb-Free".

RoHS Exempt: TI defines "RoHS Exempt" to mean products that contain lead but are compliant with EU RoHS pursuant to a specific EU RoHS exemption.

Green: TI defines "Green" to mean the content of Chlorine (Cl) and Bromine (Br) based flame retardants meet JS709B low halogen requirements of <=1000ppm threshold. Antimony trioxide based flame retardants must also meet the <=1000ppm threshold requirement.

- (3) MSL, Peak Temp. - The Moisture Sensitivity Level rating according to the JEDEC industry standard classifications, and peak solder temperature.
- (4) There may be additional marking, which relates to the logo, the lot trace code information, or the environmental category on the device.
- (5) Multiple Device Markings will be inside parentheses. Only one Device Marking contained in parentheses and separated by a "~" will appear on a device. If a line is indented then it is a continuation of the previous line and the two combined represent the entire Device Marking for that device.
- (6) Lead finish/Ball material - Orderable Devices may have multiple material finish options. Finish options are separated by a vertical ruled line. Lead finish/Ball material values may wrap to two lines if the finish value exceeds the maximum column width.

Important Information and Disclaimer:The information provided on this page represents TI's knowledge and belief as of the date that it is provided. TI bases its knowledge and belief on information provided by third parties, and makes no representation or warranty as to the accuracy of such information. Efforts are underway to better integrate information from third parties. TI has taken and continues to take reasonable steps to provide representative and accurate information but may not have conducted destructive testing or chemical analysis on incoming materials and chemicals. TI and TI suppliers consider certain information to be proprietary, and thus CAS numbers and other limited information may not be available for release.

In no event shall TI's liability arising out of such information exceed the total purchase price of the TI part(s) at issue in this document sold by TI to Customer on an annual basis.

TAPE AND REEL INFORMATION

QUADRANT ASSIGNMENTS FOR PIN 1 ORIENTATION IN TAPE

*All dimensions are nominal

Device	Package Type	Package Drawing	Pins	SPQ	Reel Diameter (mm)	Reel Width W1 (mm)	A0 (mm)	B0 (mm)	K0 (mm)	P1 (mm)	W (mm)	Pin1 Quadrant
LM2931AMX-5.0/NOPB	SOIC	D	8	2500	330.0	12.4	6.5	5.4	2.0	8.0	12.0	Q1
LM2931ASX-5.0	DDPAK/ TO-263	KTT	3	500	330.0	24.4	10.75	14.85	5.0	16.0	24.0	Q2
LM2931ASX-5.0/NOPB	DDPAK/ TO-263	KTT	3	500	330.0	24.4	10.75	14.85	5.0	16.0	24.0	Q2
LM2931CMX	SOIC	D	8	2500	330.0	12.4	6.5	5.4	2.0	8.0	12.0	Q1
LM2931CMX/NOPB	SOIC	D	8	2500	330.0	12.4	6.5	5.4	2.0	8.0	12.0	Q1
LM2931MX-5.0	SOIC	D	8	2500	330.0	12.4	6.5	5.4	2.0	8.0	12.0	Q1
LM2931MX-5.0/NOPB	SOIC	D	8	2500	330.0	12.4	6.5	5.4	2.0	8.0	12.0	Q1

TAPE AND REEL BOX DIMENSIONS

*All dimensions are nominal

Device	Package Type	Package Drawing	Pins	SPQ	Length (mm)	Width (mm)	Height (mm)
LM2931AMX-5.0/NOPB	SOIC	D	8	2500	367.0	367.0	35.0
LM2931ASX-5.0	DDPAK/TO-263	KTT	3	500	367.0	367.0	45.0
LM2931ASX-5.0/NOPB	DDPAK/TO-263	KTT	3	500	367.0	367.0	45.0
LM2931CMX	SOIC	D	8	2500	367.0	367.0	35.0
LM2931CMX/NOPB	SOIC	D	8	2500	367.0	367.0	35.0
LM2931MX-5.0	SOIC	D	8	2500	367.0	367.0	35.0
LM2931MX-5.0/NOPB	SOIC	D	8	2500	367.0	367.0	35.0

NDE0003B



KTT0003B



TS3B (Rev F)



D0008A

PACKAGE OUTLINE

SOIC - 1.75 mm max height

SMALL OUTLINE INTEGRATED CIRCUIT



4214825/C 02/2019

NOTES:

1. Linear dimensions are in inches [millimeters]. Dimensions in parenthesis are for reference only. Controlling dimensions are in inches. Dimensioning and tolerancing per ASME Y14.5M.
2. This drawing is subject to change without notice.
3. This dimension does not include mold flash, protrusions, or gate burrs. Mold flash, protrusions, or gate burrs shall not exceed $.006$ [0.15] per side.
4. This dimension does not include interlead flash.
5. Reference JEDEC registration MS-012, variation AA.

EXAMPLE BOARD LAYOUT

D0008A

SOIC - 1.75 mm max height

SMALL OUTLINE INTEGRATED CIRCUIT



LAND PATTERN EXAMPLE
 EXPOSED METAL SHOWN
 SCALE:8X



SOLDER MASK DETAILS

4214825/C 02/2019

NOTES: (continued)

- 6. Publication IPC-7351 may have alternate designs.
- 7. Solder mask tolerances between and around signal pads can vary based on board fabrication site.

EXAMPLE STENCIL DESIGN

D0008A

SOIC - 1.75 mm max height

SMALL OUTLINE INTEGRATED CIRCUIT



SOLDER PASTE EXAMPLE
BASED ON .005 INCH [0.125 MM] THICK STENCIL
SCALE:8X

4214825/C 02/2019

NOTES: (continued)

8. Laser cutting apertures with trapezoidal walls and rounded corners may offer better paste release. IPC-7525 may have alternate design recommendations.
9. Board assembly site may have different recommendations for stencil design.

EXAMPLE BOARD LAYOUT

KC0005A

TO-220 - 16.51 mm max height

TO-220

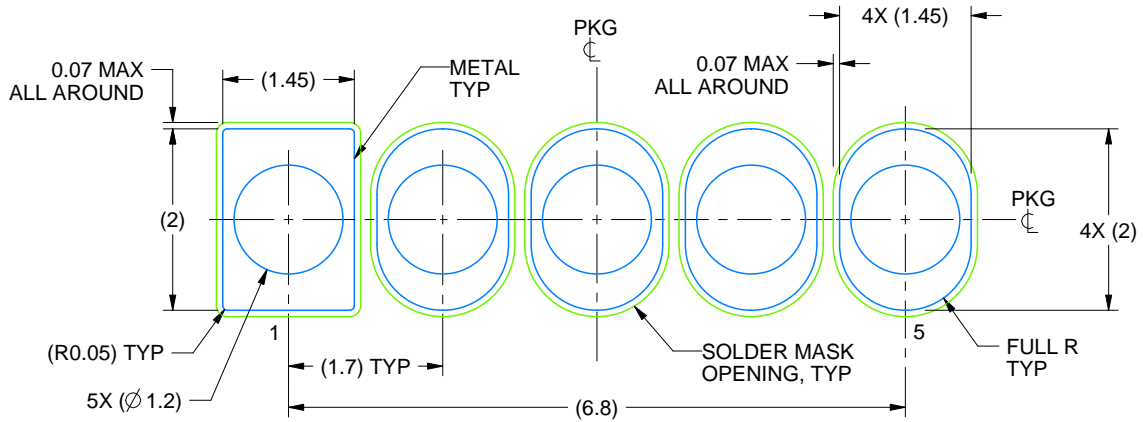

LAND PATTERN
NON-SOLDER MASK DEFINED
SCALE:12X

4215009/A 01/2017

KTT0005B



CONTROLLING DIMENSION IS INCH
 VALUES IN [] ARE MILLIMETERS
 DIMENSIONS IN () FOR REFERENCE ONLY

TS5B (Rev D)

NEB0005F

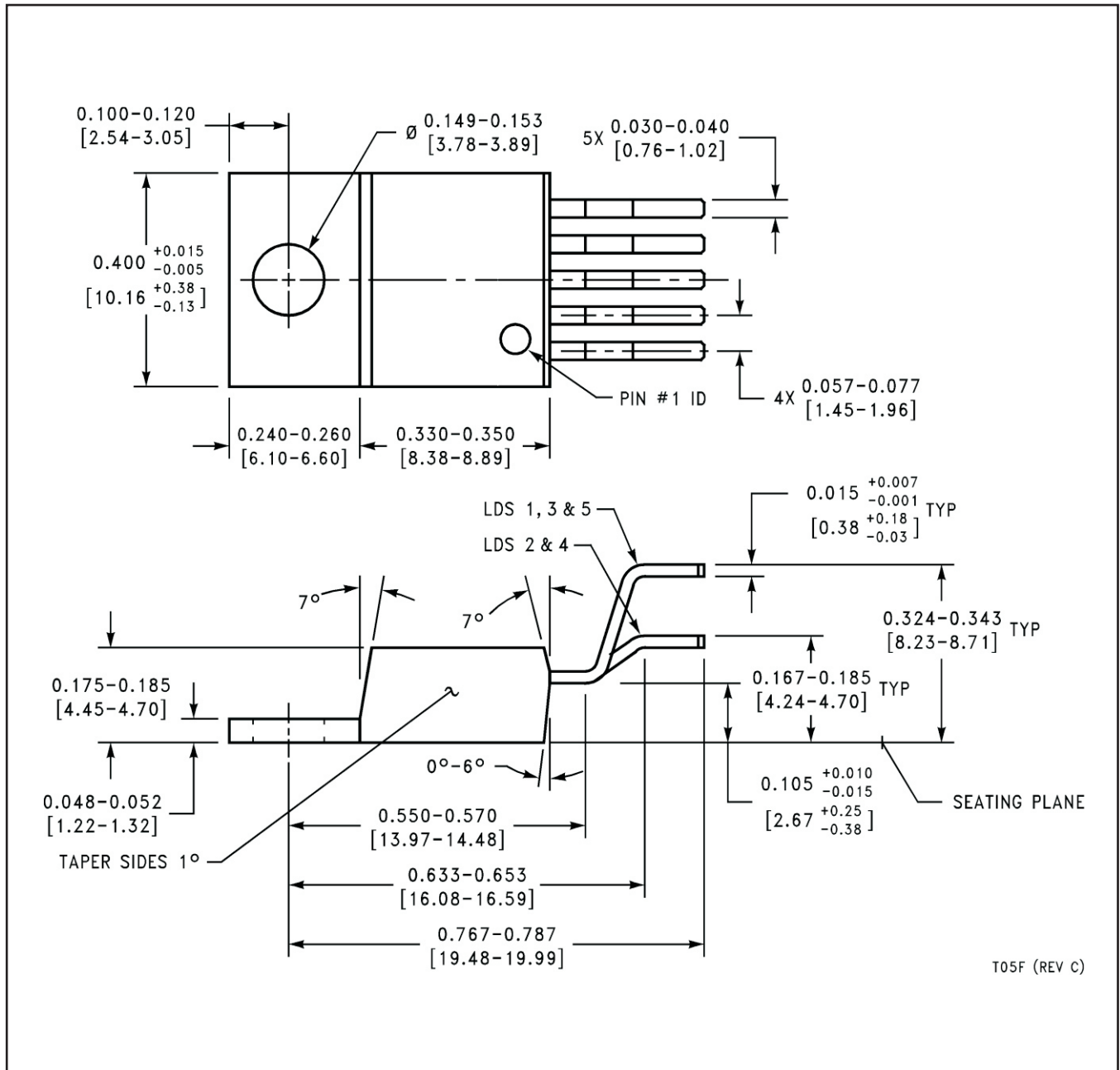

GENERIC PACKAGE VIEW

LP 3

TO-92 - 5.34 mm max height

TRANSISTOR OUTLINE



Images above are just a representation of the package family, actual package may vary.
Refer to the product data sheet for package details.

4040001-2/F

LP0003A



PACKAGE OUTLINE

TO-92 - 5.34 mm max height

TO-92



4215214/B 04/2017

NOTES:

1. All linear dimensions are in millimeters. Any dimensions in parenthesis are for reference only. Dimensioning and tolerancing per ASME Y14.5M.
2. This drawing is subject to change without notice.
3. Lead dimensions are not controlled within this area.
4. Reference JEDEC TO-226, variation AA.
5. Shipping method:
 - a. Straight lead option available in bulk pack only.
 - b. Formed lead option available in tape and reel or ammo pack.
 - c. Specific products can be offered in limited combinations of shipping medium and lead options.
 - d. Consult product folder for more information on available options.



LAND PATTERN EXAMPLE
STRAIGHT LEAD OPTION
NON-SOLDER MASK DEFINED
SCALE:15X



LAND PATTERN EXAMPLE
FORMED LEAD OPTION
NON-SOLDER MASK DEFINED
SCALE:15X

TAPE SPECIFICATIONS

LP0003A

TO-92 - 5.34 mm max height

TO-92

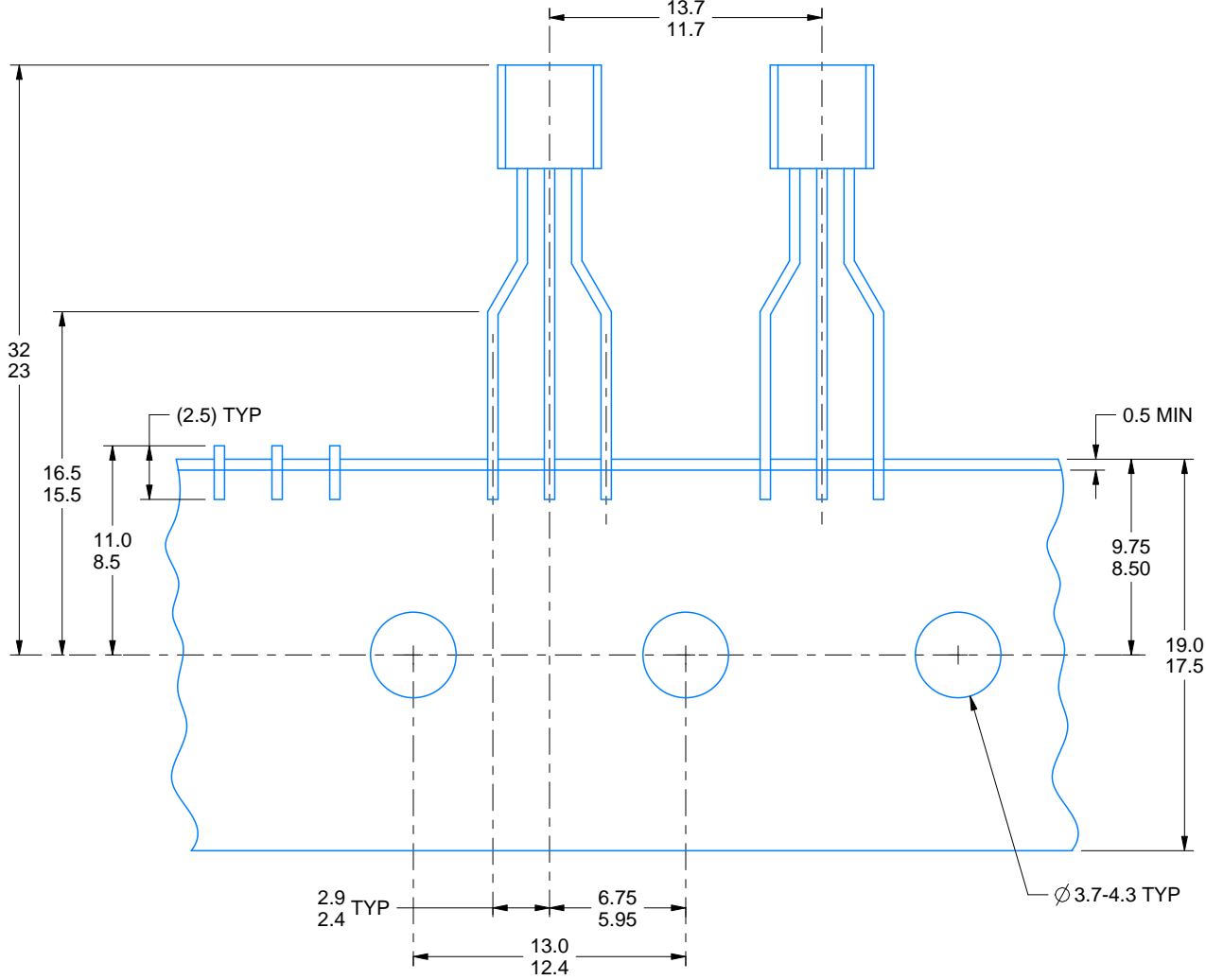

FOR FORMED LEAD OPTION PACKAGE

4215214/B 04/2017

IMPORTANT NOTICE AND DISCLAIMER

TI PROVIDES TECHNICAL AND RELIABILITY DATA (INCLUDING DATASHEETS), DESIGN RESOURCES (INCLUDING REFERENCE DESIGNS), APPLICATION OR OTHER DESIGN ADVICE, WEB TOOLS, SAFETY INFORMATION, AND OTHER RESOURCES "AS IS" AND WITH ALL FAULTS, AND DISCLAIMS ALL WARRANTIES, EXPRESS AND IMPLIED, INCLUDING WITHOUT LIMITATION ANY IMPLIED WARRANTIES OF MERCHANTABILITY, FITNESS FOR A PARTICULAR PURPOSE OR NON-INFRINGEMENT OF THIRD PARTY INTELLECTUAL PROPERTY RIGHTS.

These resources are intended for skilled developers designing with TI products. You are solely responsible for (1) selecting the appropriate TI products for your application, (2) designing, validating and testing your application, and (3) ensuring your application meets applicable standards, and any other safety, security, or other requirements. These resources are subject to change without notice. TI grants you permission to use these resources only for development of an application that uses the TI products described in the resource. Other reproduction and display of these resources is prohibited. No license is granted to any other TI intellectual property right or to any third party intellectual property right. TI disclaims responsibility for, and you will fully indemnify TI and its representatives against, any claims, damages, costs, losses, and liabilities arising out of your use of these resources.

TI's products are provided subject to TI's Terms of Sale (<https://www.ti.com/legal/termsofsale.html>) or other applicable terms available either on [ti.com](https://www.ti.com) or provided in conjunction with such TI products. TI's provision of these resources does not expand or otherwise alter TI's applicable warranties or warranty disclaimers for TI products.

Mailing Address: Texas Instruments, Post Office Box 655303, Dallas, Texas 75265
Copyright © 2021, Texas Instruments Incorporated