

The documentation and process conversion measures necessary to comply with this revision shall be completed by 09 March 1998

INCH-POUND

MIL-PRF-19500/557F
 09 December 1997
 SUPERSEDING
 MIL-S-19500/557E
 9 December 1994

PERFORMANCE SPECIFICATION SHEET

SEMICONDUCTOR DEVICE, FIELD EFFECT TRANSISTOR, N-CHANNEL, SILICON
 TYPES 2N6796, 2N6796U, 2N6798, 2N6798U, 2N6800, 2N6800U, 2N6802, AND 2N6802U
 JAN, JANTX, JANTXV, JANS, JANHC, AND JANKC

This specification is approved for use by all Departments and Agencies of the Department of Defense.

1. SCOPE

1.1 Scope. This specification covers the performance requirements for a N-channel, enhancement-mode, MOSFET, power transistor intended for use in high density power switching applications. Three levels of product assurance are provided for each encapsulated device type as specified in MIL-PRF-19500. Two levels of product assurance are provided for each unencapsulated device type.

1.2 Physical dimensions. See figure 1, TO-205AF (formerly TO-39), figure 3 (LCC), and figure 4 for JANHC and JANKC die dimensions.

1.3 Maximum ratings. Unless otherwise specified, $T_A = +25^\circ\text{C}$.

Type 3/	P_T 1/ $T_C = +25^\circ\text{C}$	P_T $T_A = +25^\circ\text{C}$	V_{DS}	V_{DG}	V_{GS}	I_{D1} 2/ $T_C = +25^\circ\text{C}$	I_{D2} 2/ $T_C = +100^\circ\text{C}$	I_S	I_{DM}	T_J and T_{STG}
	<u>W</u>	<u>W</u>	<u>V dc</u>	<u>V dc</u>	<u>V dc</u>	<u>A dc</u>	<u>A dc</u>	<u>A dc</u>	<u>A(pk)</u>	<u>°C</u>
2N6796	25	0.8	100	100	± 20	8.0	5.0	8.0	32	-55 to +150
2N6798	25	0.8	200	200	± 20	5.5	3.5	5.5	22	-55 to +150
2N6800	25	0.8	400	400	± 20	3.0	2.0	3.0	14	-55 to +150
2N6802	25	0.8	500	500	± 20	2.5	1.5	2.5	11	-55 to +150

1/ Derate linearly $0.2\text{ W}^\circ\text{C}$ for $T_C > +25^\circ\text{C}$. $T_{J\text{max}} - T_C$

$$P_T = \frac{\quad}{R_{\theta JC}}$$

2/

$$I_D = \sqrt{\frac{T_{J(\text{max})} - T_C}{(R_{\theta JX}) \times (R_{DS(on)} \text{ at } T_{J(\text{max})})}}$$

3/ Electrical characteristics for "U" suffix devices are identical to the corresponding non"U" suffix devices unless otherwise specified.

Beneficial comments (recommendations, additions, deletions) and any pertinent data which may be of use in improving this document should be addressed to: Commander, Defense Supply Center Columbus, ATTN: DSCC-VAT, 3990 East Broad St., Columbus, OH 43216-5000, by using the addressed Standardization Document Improvement Proposal (DD Form 1426) appearing at the end of this document or by letter.

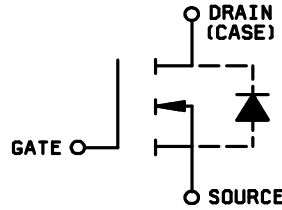

SCHEMATIC CIRCUIT

Ltr	Dimensions				Notes
	Inches		Millimeters		
	Min	Max	Min	Max	
CH	.160	.180	4.07	4.57	
LC	.200 TP		5.08 TP		6
LD	.016	.021	0.41	0.53	7,8
LU	.016	.019	0.41	0.48	7,8
HD	.335	.370	8.51	9.40	
CD	.305	.335	7.75	8.51	
TW	.028	.034	0.71	0.86	2
TL	.029	.045	0.74	1.14	3
LL	.500	.750	12.70	19.05	7,8
L ₁		.050		1.27	7,8
L ₂	.250		6.35		7,8
P	.100		2.54		5
Q		.050		1.27	4
r		.010		0.25	9
a	45 TP		45 TP		6

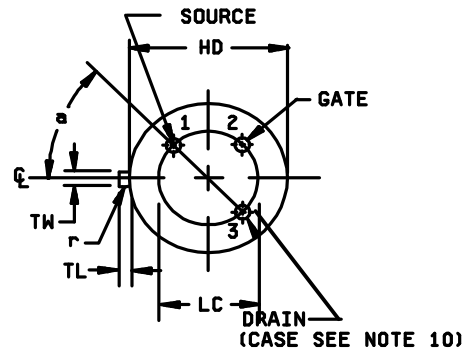
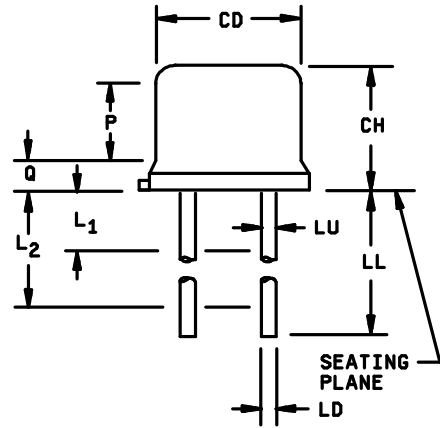

NOTES:

1. Dimensions are inches. Metric equivalents are given for general information only.
2. Beyond radius (r) maximum, TW shall be held for a minimum length of .011 inch (0.028 mm).
3. Dimension TL measured from maximum HD.
4. Outline in this zone is not controlled.
5. Dimension CD shall not vary more than .010 inch (0.25 mm) in zone P. This zone is controlled for automatic handling.
6. Leads at gauge plane .054 +.001, -.000 inch (1.37 +0.03, -0.00 mm) below seating plane shall be within .007 inch (0.18 mm) radius of true position (TP) at maximum material condition (MMC) relative to tab at MMC. The device may be measured by direct methods or by the gauge and gauging procedure shown on figure 2.
7. LU applies between L₁ and L₂. LD applies between L₂ and LL minimum. Diameter is uncontrolled in L₁ and beyond LL min.
8. All three leads.
9. Radius (r) applies to both inside corners of tab.
10. Drain is electrically connected to the case.
11. In accordance with ANSI Y14.5M, diameters are equivalent to ϕ x symbology.

FIGURE 1. Physical dimensions for TO-205AF.

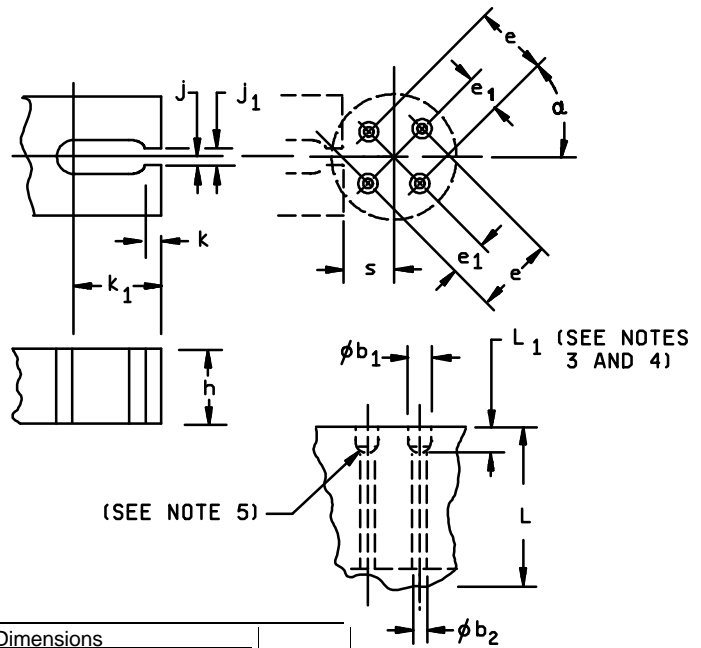

Ltr	Dimensions				Notes
	Inches		Millimeters		
	Min	Max	Min	Max	
ϕb_1	.0595	.0605	1.511	1.537	
ϕb_2	.0325	.0335	0.826	0.851	
e	.1995	.2005	5.067	5.093	
e ₁	.0995	.1005	2.527	2.553	
h	.150 Nominal		3.81 Nominal		
j	.0175	.0180	0.444	0.457	
j ₁	.0350	.0355	0.889	0.902	
k	.009	.011	0.23	0.28	
k ₁	.125 Nominal		3.18 Nominal		
L	.372	.378	9.45	9.60	
L ₁	.054	.055	1.37	1.40	
S	.182	.199	4.62	5.05	2
α	44.90°	45.10°	44.90°	45.10°	

NOTES:

1. Dimensions are in inches. Metric equivalents are given for general information only.
2. The location of the tab locator within the limits indicated will be determined by the tab and flange dimensions of the device being checked.
3. Gauging procedure. The device being measured shall be inserted until its seating plane is .125 ±.010 inch (3.18 ±0.25 mm) from the seating surface of the gauge. A force of 8 ±.5 ounces shall then be applied parallel and symmetrical to the device's cylindrical axis. When examined visually after the force application (the force need not be removed), the seating plane of the device shall be seated against the gauge. The use of a pin straightener prior to insertion in the gauge is permissible.
4. Gauging plane.
5. Drill angle.

FIGURE 2. Gauge for lead and tab locations.

MIL-PRF-19500/557F

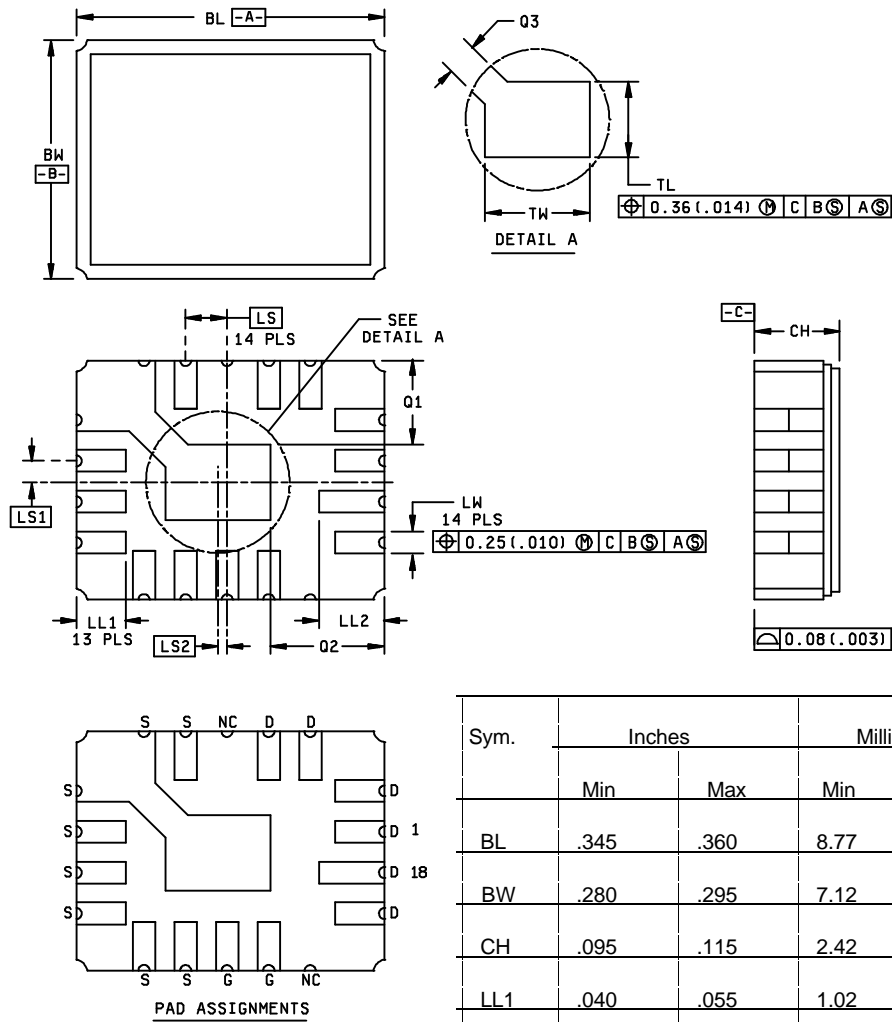

Sym.	Inches		Millimeters	
	Min	Max	Min	Max
BL	.345	.360	8.77	9.14
BW	.280	.295	7.12	7.49
CH	.095	.115	2.42	2.92
LL1	.040	.055	1.02	1.39
LL2	.055	.065	1.40	1.65
LS	.050 BSC		1.27 BSC	
LS1	.025 BSC		0.635 BSC	
LS2	.008 BSC		0.203 BSC	
LW	.020	.030	0.51	0.76
Q1	.105 REF		2.67 REF	
Q2	.120 REF		3.05 REF	
Q3	.045	.055	1.15	1.39
TL	.070	.080	1.78	2.03
TW	.120	.130	3.05	3.30

NOTES:

1. Dimensions are in inches. Metric equivalents are given for information only.
2. In accordance with ANSI Y14.5M, diameters are equivalent to ϕ x symbology.

FIGURE 3. Physical dimensions for LCC.

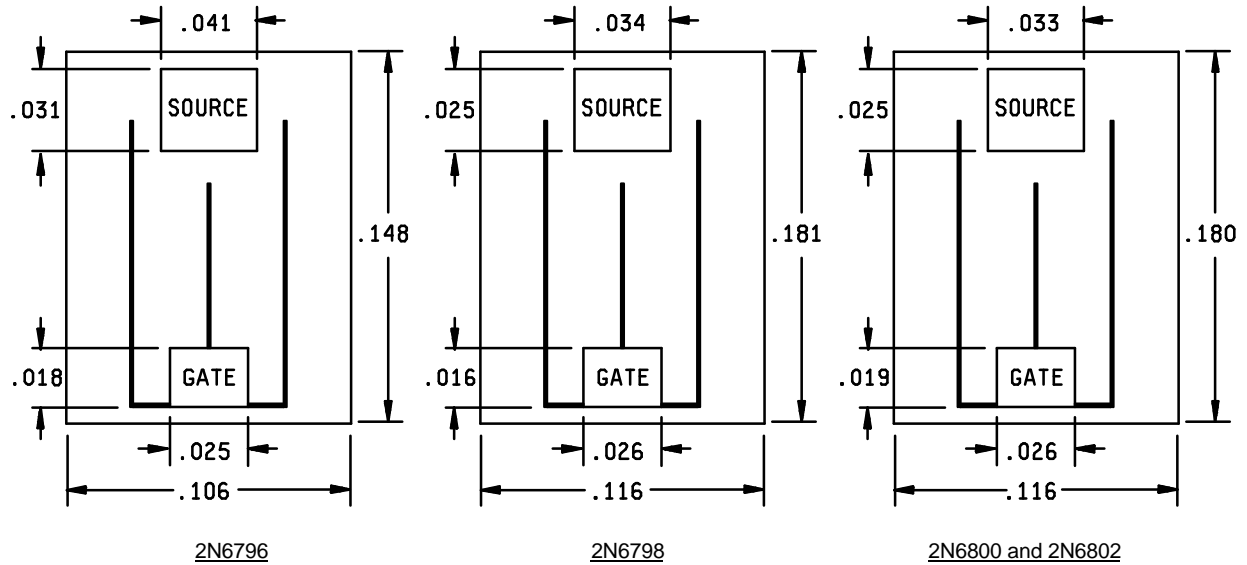

Inch	mm	Inch	mm	Inch	mm
.016	0.41	.031	0.79	.116	2.95
.018	0.46	.033	0.84	.148	3.76
.019	0.48	.034	0.86	.180	4.57
.025	0.64	.041	1.04	.181	4.60
.026	0.66	.106	2.69		

NOTES:

1. Dimensions are in inches.
2. Metric equivalents are given for general information only.
3. Unless otherwise specified, tolerance is ± 0.005 inch (± 0.13 mm).
4. The physical characteristics of the die are: the back metals are chromium, nickel, and silver. The top metal is aluminum and the back contact is the drain.
5. Die thickness is .0187 inch (0.475 mm).

FIGURE 4. JANHCA and JANKCA die dimensions.

1.4 Primary electrical characteristics at $T_C = +25^\circ\text{C}$.

Type 2/	Min $V_{(BR)DSS}$ $V_{GS} = 0\text{ V dc}$ $I_D = 1.0\text{ mA dc}$	$V_{GS(th)1}$ $V_{DS} \geq V_{GS}$ $I_D = 0.25\text{ mA dc}$	Max I_{DSS1} $V_{GS} = 0\text{ V dc}$	Max $r_{DS(on)1}$ / $V_{GS} = 10\text{ V dc}$		$R_{\theta JC}$ maximum	
			$V_{DS} = 80$ percent of rated V_{DS}	$T_J = +25^\circ\text{C}$ at I_{D2}	$T_J = +150^\circ\text{C}$ at I_{D2}		
	<u>V dc</u>	<u>V dc</u> Min Max		<u>$\mu\text{A dc}$</u>	<u>ohm</u>	<u>ohm</u>	<u>$^\circ\text{C/W}$</u>
2N6796	100	2.0	4.0	25	0.18	0.39	5.0
2N6798	200	2.0	4.0	25	0.40	0.84	5.0
2N6800	400	2.0	4.0	25	1.00	2.78	5.0
2N6802	500	2.0	4.0	25	1.50	4.00	5.0

1/ Pulsed (see 4.5.1).

2/ Electrical characteristics for "U" suffix devices are identical to the corresponding non"U" suffix devices unless otherwise specified.

2. APPLICABLE DOCUMENTS

2.1 Government documents.

2.1.1 Specifications, standards, and handbooks. The following specifications, standards, and handbooks form a part of this document to the extent specified herein. Unless otherwise specified, the issues of these documents are those listed in the issue of the Department of Defense Index of Specifications and Standards (DODISS) and supplement thereto, cited in the solicitation (see 6.3).

SPECIFICATION

MILITARY

MIL-PRF-19500 - Semiconductor Devices, General Specification for.

STANDARD

MILITARY

MIL-STD-750 - Test Methods for Semiconductor Devices.

(Unless otherwise indicated, copies of federal and military specifications, standards, and handbooks are available from the Defense Printing Service Detachment Office, Building 4D (Customer Service), 700 Robbins Avenue, Philadelphia, PA 19111-5094.)

2.2 Order of precedence. In the event of a conflict between the text of this document and the references cited herein, the text of this document takes precedence. Nothing in this document, however, supersedes applicable laws and regulations unless a specific exemption has been obtained.

3. REQUIREMENTS

3.1 Associated specification. The individual item requirements shall be in accordance with MIL-PRF-19500 and as specified herein.

3.2 Abbreviations, symbols, and definitions. Abbreviations, symbols, and definitions used herein shall be as specified in MIL-PRF-19500 and as follows:

C -----	Coulomb.
g_{FS} -----	DC forward transconductance.
I_S -----	Source current through drain (forward biased V_{SD}).
$V_{(BR)DSS}$ -----	Drain to source breakdown voltage, all other terminals short-circuited to source.
$I_{(ISO)}$ -----	Source pin to case isolation current.

3.3 Interface requirements and physical dimensions. The Interface requirements and physical dimensions shall be as specified in MIL-PRF-19500, and figures 1 (T0-39), 3 (LCC) and 4 (die) herein.

3.3.1 Lead material and finish. Lead material shall be Kovar, Alloy 52 (for the T0-205AF), and a copper or plated core is permitted. Lead finish shall be solderable in accordance with MIL-PRF-19500, MIL-STD-750, and herein. Where a choice of lead finish is desired, it shall be specified in the acquisition document (see 6.3).

3.3.2 Internal construction. Multiple chip construction shall not be permitted.

3.4 Marking. Marking shall be in accordance with MIL-PRF-19500. At the option of the manufacturer, marking of country of origin may be omitted from the body of the transistor, but shall be retained on the initial container.

3.5 Electrostatic discharge protection. The devices covered by this specification require electrostatic protection.

3.5.1 Handling. MOS devices must be handled with certain precautions to avoid damage due to the accumulation of static charge. The following handling practices shall be followed:

- a. Devices shall be handled on benches with conductive handling devices.
- b. Ground test equipment, tools, and personnel handling devices.
- c. Do not handle devices by the leads.
- d. Store devices in conductive foam or carriers.
- e. Avoid use of plastic, rubber, or silk in MOS areas.
- f. Maintain relative humidity above 50 percent, if practical.
- g. Care shall be exercised, during test and troubleshooting, to apply not more than maximum rated voltage to any lead.
- h. Gate must be terminated to source, $R \leq 100 \text{ k}$, whenever bias voltage is to be applied drain to source.

3.6 Electrical performance characteristics. Unless otherwise specified herein, the electrical performance characteristics are as specified in 1.3, 1.4, and table I.

3.7 Electrical test requirements. The electrical test requirements shall be the subgroups specified in 4.4.2 and 4.4.3.

3.8 Qualification. Devices furnished under this specification shall be products that are authorized by the qualifying activity for listing on the applicable qualified products list before contract award (see 4.2 and 6.2).

4. VERIFICATION

4.1 Classification of Inspections. The inspection requirements specified herein are classified as follows:

- a. Qualification inspection (see 4.2).
- b. Screening (see 4.3)
- c. Conformance inspection (see 4.4).

4.2 Qualification inspection. Qualification inspection shall be in accordance with MIL-PRF-19500. Alternate flow is allowed for qualification inspection in accordance with MIL-PRF-19500.

4.2.1 Group E inspection. Group E inspection shall be conducted in accordance with MIL-PRF-19500 and table II herein.

4.2.2 JANHC and JANKC die. Qualification shall be in accordance with MIL-PRF-19500.

4.3 Screening (JANS, JANTX, and JANTXV levels only). Screening shall be in accordance with table IV of MIL-PRF-19500 and as specified herein. The following measurements shall be made in accordance with table I herein. Devices that exceed the limits of table I herein shall not be acceptable.

4.3.1 Screening (JANHC and JANKC). Screening of die shall be in accordance with MIL-PRF-19500. As a minimum, die shall be 100-percent probed in accordance with group A, subgroup 2 except test current shall not exceed 20 A.

Screen (see table IV of MIL-PRF-19500)	Measurement	
	JANS level	JANTX and JANTXV levels
<u>1/</u>	Gate stress test (see 4.5.5)	Gate stress test (see 4.5.5)
<u>1/</u>	Method 3161 (see 4.5.3)	Method 3161 (see 4.5.3)
<u>2/</u>	Method 3470 (optional)	Method 3470 (optional)
3	Method 1051, test condition G	Method 1051, test condition G
9 <u>1/</u>	I _{GSS1} , I _{DSS1} , subgroup 2 of table I herein	Subgroup 2 of table I herein
10	Method 1042, test condition B	Method 1042, test condition B
11	I _{GSS1} , I _{DSS1} , r _{DS(on)1} , V _{GS(th)1} , subgroup 2 of table I herein; ΔI _{GSS1} = ±20 nA dc or ±100 percent of initial value, whichever is greater. ΔI _{DSS1} = ±25 μA dc or ±100 percent of initial value, whichever is greater.	I _{GSS1} , I _{DSS1} , r _{DS(on)1} , V _{GS(th)1} , subgroup 2 of table I herein.
12	Method 1042, test condition A, t = 240 hours	Method 1042, test condition A
13	Subgroups 2 and 3 of table I herein; ΔI _{GSS1} = ±20 nA dc or ±100 percent of initial value, whichever is greater. ΔI _{DSS1} = ±25 μA dc or ±100 percent of initial value, whichever is greater. Δr _{DS(on)1} = ±20 percent of initial value. ΔV _{GS(th)1} = ±20 percent of initial value.	Subgroup 2 of table I herein; ΔI _{GSS1} = ±20 nA dc or ±100 percent of initial value, whichever is greater. ΔI _{DSS1} = ±25 μA dc or ±100 percent of initial value, whichever is greater. Δr _{DS(on)1} = ±20 percent of initial value. ΔV _{GS(th)1} = ±20 percent of initial value.

1/ Shall be performed anytime before screen 10.

2/ Method 3470 is optional if performed as a sample in group A, subgroup 5.

4.4 Conformance inspection. Conformance inspection shall be in accordance with MIL-PRF-19500. Alternate flow is allowed for conformance inspection in accordance with MIL-PRF-19500.

4.4.1 Group A inspection. Group A inspection shall be conducted in accordance with MIL-PRF-19500 and table I herein. Electrical measurements (end-points) shall be in accordance with the inspections of table I, group A, subgroup 2 herein.

4.4.2 Group B inspection. Group B inspection shall be conducted in accordance with the conditions specified for subgroup testing in table VIa (JANS) and table VIb (JAN, JANTX, and JANTXV) of MIL-PRF-19500 and herein. Electrical measurements (end-points) shall be in accordance with the inspections of table I, group A, subgroup 2 herein.

4.4.2.1 Group B inspection, table VIa (JANS) of MIL-PRF-19500.

<u>Subgroup</u>	<u>Method</u>	<u>Condition</u>
3	1051	Test condition G.
4	1042	Test condition D; 2,000 cycles. The heating cycle shall be 1 minute minimum.
5	1042	Accelerated steady-state operation life; test condition A; $V_{DS} = \text{rated}$ $T_A = +175^\circ \text{C}$, $t = 120$ hours. Read and record $V_{(BR)DSS}$ (pre and post) at $1 \text{ mA} = I_D$. Read and record I_{DSS} (pre and post). Deltas for $V_{(BR)DSS}$ shall not exceed 10 percent and I_{DSS} shall not exceed $25 \mu\text{A}$. Accelerated steady-state gate stress; condition B, $V_{GS} = \text{rated}$, $T_A = +175^\circ \text{C}$, $t = 24$ hours.
5	2037	Bond strength (Al-Au die interconnects only); test condition A.
6	3161	See 4.5.2.

4.4.2.2 Group B inspection, table VIb (JAN, JANTX, and JANTXV) of MIL-PRF-19500.

<u>Subgroup</u>	<u>Method</u>	<u>Condition</u>
2	1051	Test condition G.
3	1042	Test condition D, 2,000 cycles. The heating cycle shall be 1 minute minimum.
3	2037	Test condition A. All internal bond wires for each device shall be pulled separately.

4.4.3 Group C inspection. Group C inspection shall be conducted in accordance with the conditions specified for subgroup testing in table VII of MIL-PRF-19500 and as follows. Electrical measurements (end-points) shall be in accordance with the inspections of table I, group A, subgroup 2 herein.

<u>Subgroup</u>	<u>Method</u>	<u>Condition</u>
2	2036	Test condition E (Not required for LCC).
6	1042	Test condition D, 6,000 cycles. The heating cycle shall be 1 minute minimum.

4.5 Methods of inspection. Methods of inspection shall be as specified in the appropriate tables and as follows.

4.5.1 Pulse measurements. Conditions for pulse measurement shall be as specified in section 4 of MIL-STD-750.

4.5.2 Thermal resistance. Thermal resistance measurements shall be performed in accordance with method 3161 of MIL-STD-750. $R_{\theta JC(\text{max})} = 5.0^\circ \text{C/W}$.

- | | |
|---|---|
| a. Measuring current (I_M) - - - - - | 10 mA. |
| b. Drain heating current (I_H) - - - - - | 1 A minimum, (1.3 A minimum for LCC.) |
| c. Heating time (t_H) - - - - - | Steady-state (see MIL-STD-750, method 3161 for definition). |
| d. Drain-source heating voltage (V_H) - - - - - | 25 V dc, (15 V dc minimum for LCC). |
| e. Measurement time delay (t_{MD}) - - - - - | 10 to 80 μs . |
| f. Sample window time (t_{SW}) - - - - - | 10 μs maximum. |

4.5.3 Thermal impedance ($Z_{\theta JC}$ measurements). The $Z_{\theta JC}$ measurements shall be performed in accordance with MIL-STD-750, method 3161. The maximum limit (not to exceed figure 5, thermal impedance cures and the group A, subgroup 2 limits) for $Z_{\theta JC}$ in screening (table IV of MIL-PRF-19500) shall be derived by each vendor by means of statistical process control. When the process has exhibited control and capability, the capability data shall be used to establish the fixed screening limit. In addition to screening, once a fixed limit has been established, monitor all future sealing lots using a random five piece sample from each lot to be plotted on the applicable X, R chart. If a lot exhibits an out of control condition, the entire lot shall be removed from the line and held for engineering evaluation and disposition. This procedure may be used in lieu of an inline process monitor.

- | | |
|---|---|
| a. Measuring current (I_M) ----- | 10 mA. |
| b. Drain heating current (I_H) ----- | 1 A minimum , (1.3 A minimum for LCC). |
| c. Heating time (t_H) ----- | 10 ms. |
| d. Drain-source heating voltage (V_H) ----- | 25 V dc minimum, , (15 V dc minimum for LCC). |
| e. Measurement time delay (t_{MD}) ----- | 30 to 60 μ s. |
| f. t_{SW} sample window time ----- | 10 μ s (maximum). |

4.5.4 Unclamped inductive switching.

- | | |
|---|---|
| a. Peak current (I_D) ----- | rated I_{D1} . |
| b. Peak gate voltage (V_{GS}) ----- | 10 V dc. |
| c. Gate to source resistor (R_{GS}) ----- | $25\Omega \leq R_{GS} \leq 200\Omega$. |
| d. Initial case temperature (T_C) ----- | +25° C +10° C, -5° C. |
| e. Inductance (L) ----- | 100 μ H \pm 10 percent. |
| f. Number of pulses to be applied ----- | 1 pulse minimum. |
| g. Pulse repetition rate ----- | None. |

4.5.5 Gate stress test.

$V_{GS} = \pm 30$ V dc minimum.

$t = 250$ μ s minimum.

TABLE I. Group A inspection.

Inspection <u>1/</u> , <u>4/</u>	MIL-STD-750		Symbol	Limits		Unit
	Method	Conditions		Min	Max	
<u>Subgroup 1</u>						
Visual and mechanical inspection	2071					
<u>Subgroup 2</u>						
Thermal impedance <u>2/</u>	3161	See 4.5.3	$Z_{\theta JC}$		1.4	$^{\circ}C/W$
Breakdown voltage, drain to source	3407	$V_{GS} = 0$ V dc; $I_D = 1.0$ mA dc; Bias condition C	$V_{(BR)DSS}$			
2N6796				100		V dc
2N6798				200		V dc
2N6800				400		V dc
2N6802				500		V dc
Gate to source voltage (threshold)	3403	$V_{DS} \geq V_{GS}$; $I_D = 0.25$ mA dc	$V_{GS(th)1}$	2.0	4.0	V dc
Gate current	3411	Bias condition C; $V_{DS} = 0$ V dc; $V_{GS} = +20$ V dc and -20 V dc	I_{GSS1}		± 100	nA dc
Drain current	3413	$V_{GS} = 0$; bias condition C; $V_{DS} = 0$ V dc; $V_{DS} = 80$ percent of rated V_{DS}	I_{DSS1}		25	μA dc
Static drain to source on-state resistance	3421	$V_{GS} = 10$ V dc; condition A; pulsed (see 4.5.1); $I_D = I_{D2}$	$r_{DS(on)1}$			
2N6796					0.18	Ω
2N6798					0.40	Ω
2N6800					1.00	Ω
2N6802					1.50	Ω
Drain to source on-state resistance	3421	$V_{GS} = 10$ V dc; condition A; pulsed (see 4.5.1); $I_D = I_{D1}$	$r_{DS(on)2}$			
2N6796					0.195	Ω
2N6798					0.420	Ω
2N6800					1.100	Ω
2N6802					1.600	Ω
Forward voltage (source drain diode)	4011	Pulsed (see 4.5.1); $V_{GS} = 0$ V dc; $I_S = I_{D1}$	V_{SD}			
2N6796					1.5	V dc
2N6798					1.4	V dc
2N6800					1.4	V dc
2N6802					1.4	V dc

See footnotes at end of table.

TABLE I. Group A inspection - Continued.

Inspection <u>1/</u> , <u>4/</u>	MIL-STD-750		Symbol	Limits		Unit
	Method	Conditions		Min	Max	
<u>Subgroup 3</u>						
High temperature operation:						
$T_C = T_J = +125^\circ \text{C}$						
Gate current	3411	Bias condition C; $V_{DS} = 0 \text{ V dc}$; $V_{GS} = +20 \text{ V dc}$ and -20 V dc	I_{GSS2}		± 200	nA dc
Drain current	3413	Bias condition C; $V_{GS} = 0 \text{ V dc}$; $V_{DS} = 80 \text{ percent rated } V_{DS}$	I_{DSS2}		.25	mA dc
Gate to source voltage (threshold)	3403	$V_{DS} \geq V_{GS}$; $I_D = 0.25 \text{ mA}$	$V_{GS(th)2}$	1.0		V dc
Static drain to source on-state resistance	3421	$V_{GS} = 10 \text{ V dc}$; pulsed (see 4.5.1); $I_D = I_{D2}$	$r_{DS(on)3}$			
2N6796					0.35	ohms
2N6798					0.75	ohms
2N6800					2.40	ohms
2N6802					3.50	ohms
Low temperature operation:						
$T_C = T_J = -55^\circ \text{C}$						
Gate to source voltage (threshold)	3403	$V_{DS} \geq V_{GS}$; $I_D = 0.25 \text{ mA}$	$V_{GS(th)3}$		5.0	V dc
<u>Subgroup 4</u>						
Switching time test						
3472 $I_D = \text{rated } I_{D1}$ (see 1.3); $V_{GS} = +10 \text{ V dc}$; $R_G = 7.5 \ \Omega$;						
Turn-on delay time			$t_{d(on)}$			
2N6796		$V_{DD} = 30 \text{ V dc}$			30	ns
2N6798		$V_{DD} = 77 \text{ V dc}$			30	ns
2N6800		$V_{DD} = 176 \text{ V dc}$			30	ns
2N6802		$V_{DD} = 225 \text{ V dc}$			30	ns
Rise time			t_r			
2N6796		$V_{DD} = 30 \text{ V dc}$			75	ns
2N6798		$V_{DD} = 77 \text{ V dc}$			50	ns
2N6800		$V_{DD} = 176 \text{ V dc}$			35	ns
2N6802		$V_{DD} = 225 \text{ V dc}$			30	ns

See footnotes at end of table.

TABLE I. Group A inspection - Continued.

Inspection <u>1/</u> , <u>4/</u>	MIL-STD-750		Symbol	Limits		Unit
	Method	Conditions		Min	Max	
<u>Subgroup 4</u> - Continued						
Turn-off delay time			$t_{d(off)}$			
2N6796		$V_{DD} = 30 \text{ V dc}$		40	ns	
2N6798		$V_{DD} = 77 \text{ V dc}$		50	ns	
2N6800		$V_{DD} = 176 \text{ V dc}$		55	ns	
2N6802		$V_{DD} = 225 \text{ V dc}$		55	ns	
Fall time			t_f			
2N6796		$V_{DD} = 30 \text{ V dc}$		45	ns	
2N6798		$V_{DD} = 77 \text{ V dc}$		40	ns	
2N6800		$V_{DD} = 176 \text{ V dc}$		35	ns	
2N6802		$V_{DD} = 225 \text{ V dc}$		30	ns	
<u>Subgroup 5</u>						
Single pulse unclamped inductive switching <u>3/</u>	3470	See 4.5.4				
Electrical measurements		See table I, group A, subgroup 2				
Safe operating area test	3474	See figure 6; $V_{DS} = 80 \text{ percent of rated } V_{DS}$; $V_{DS} \leq 200 \text{ V dc maximum}$ $t_p = 10 \text{ ms}$				
Electrical measurements		See table I, group A, subgroup 2				
<u>Subgroup 6</u>						
Not applicable						
<u>Subgroup 7</u>						
Gate charge	3471	Condition B				
<u>Test 1</u>						
On-state gate charge			$Q_{g(on)}$			
2N6796				28.51	nC	
2N6798				42.07	nC	
2N6800				32.97	nC	
2N6802				29.53	nC	

See footnotes at end of table.

TABLE I. Group A inspection - Continued.

Inspection <u>1/</u> , <u>4/</u>	MIL-STD-750		Symbol	Limits		Unit
	Method	Conditions		Min	Max	
<u>Subgroup 7</u> - Continued						
<u>Test 2</u>						
Gate to source charge			Q_{gs}			
2N6796					6.34	nC
2N6798					5.29	nC
2N6800					5.75	nC
2N6802					4.46	nC
<u>Test 3</u>						
Gate to drain charge			Q_{gd}			
2N6796					16.59	nC
2N6798					28.11	nC
2N6800					16.59	nC
2N6802					28.11	nC
Reverse recovery time	3473	$V_{DD} \leq 50$ V dc	t_{rr}			
2N6796		$di/dt \leq 100$ A/ μ s; $I_F = 8.0$ A			300	ns
2N6798		$di/dt \leq 100$ A/ μ s; $I_F = 5.5$ A			500	ns
2N6800		$di/dt \leq 100$ A/ μ s; $I_F = 3.0$ A			700	ns
2N6802		$di/dt \leq 100$ A/ μ s; $I_F = 2.5$ A			900	ns

1/ For sampling plan, see MIL-PRF-19500.

2/ This test is required for the following end-point measurements only (not intended for screen 13):

JANS - group B, subgroups 3 and 4

JAN, JANTX and JANTXV - group B, subgroups 2 and 3;
group C, subgroup 6;
group E, subgroup 1

3/ This test is optional if performed as a 100 percent screen.

4/ Electrical characteristics for "U" suffix devices are identical to the corresponding non"U" suffix devices unless otherwise specified.

TABLE II. Group E inspection (all quality levels) for qualification only.

Inspection <u>1/</u>	MIL-STD-750		Qualification conformance inspection
	Method	Conditions	
<u>Subgroup 1</u>			45 devices, c = 0
Thermal shock (temperature cycling)	1051	Condition G, 500 cycles	
Electrical measurements		See table 1, group A, subgroup 2	
<u>Subgroup 2 <u>2/</u></u>			45 devices, c = 0
Steady-state reverse bias	1042	Condition A; 1,000 hours	
Electrical measurements		See table 1, group A, subgroup 2	
Steady-state gate bias	1042	Condition B; 1,000 hours	
Electrical measurements		See table 1, group A, subgroup 2	
<u>Subgroup 3</u>			
Not applicable			
<u>Subgroup 4</u>			5 devices, c = 0
Thermal resistance	3161	$R_{\theta JC} = 5.0^{\circ} C/W$ maximum, see 4.5.2	
<u>Subgroup 5</u>			
Not applicable			

1/ JANHC and JANKC devices are qualified in accordance with MIL-PRF-19500.

2/ A separate sample may be pulled for each test.

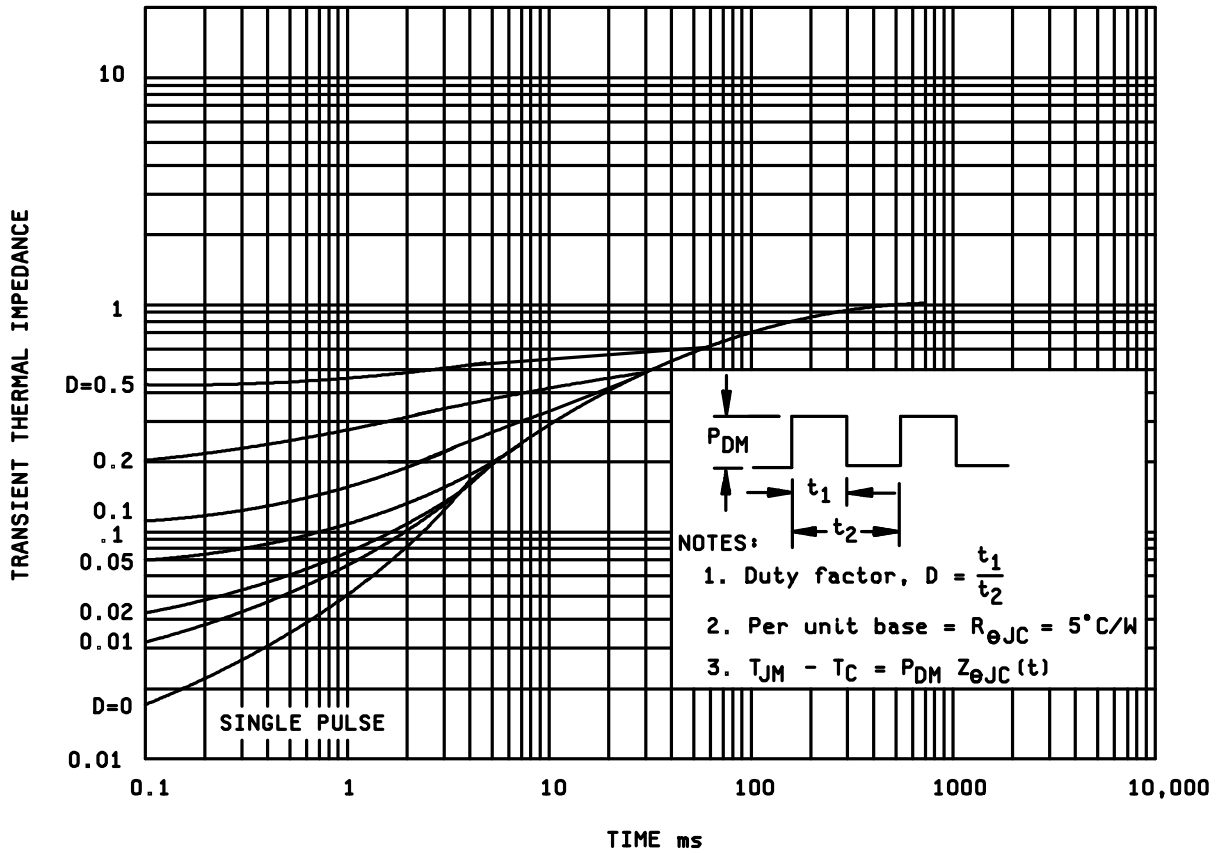

2N6796, 2N6798, 2N6800 AND 2N6802

(also applies to the corresponding "U" suffix devices)

FIGURE 5. Normalized transient thermal impedance.

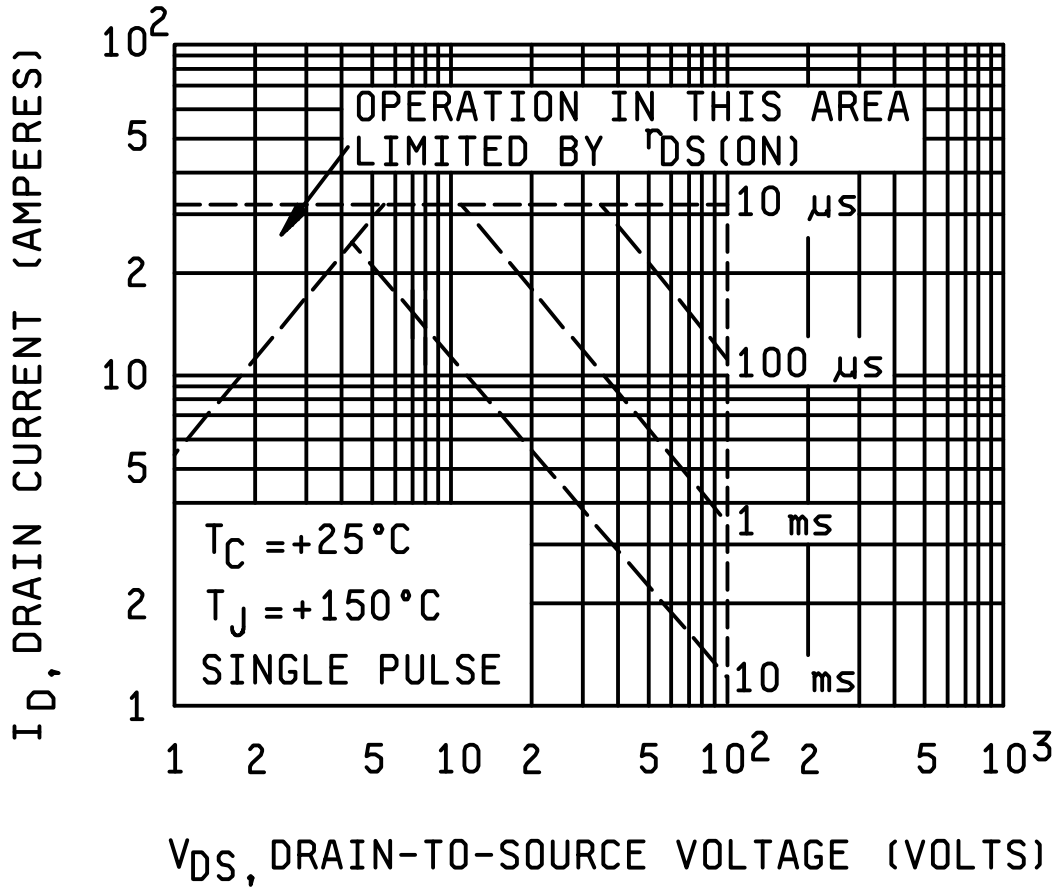

2N6796, 2N6796U

FIGURE 6. Maximum safe operating area.

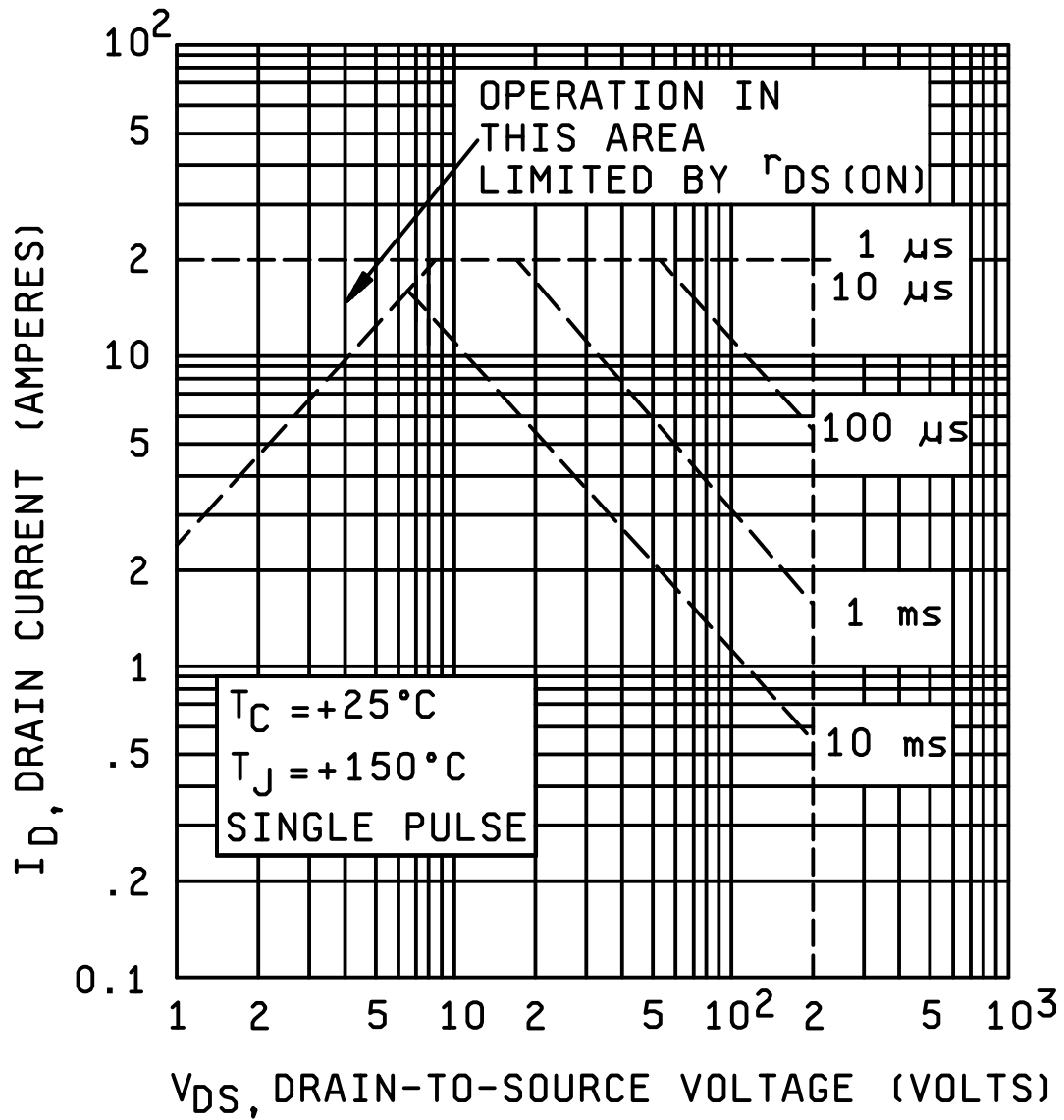

2N6798, 2N6798U

FIGURE 6. Maximum safe operating area - Continued.

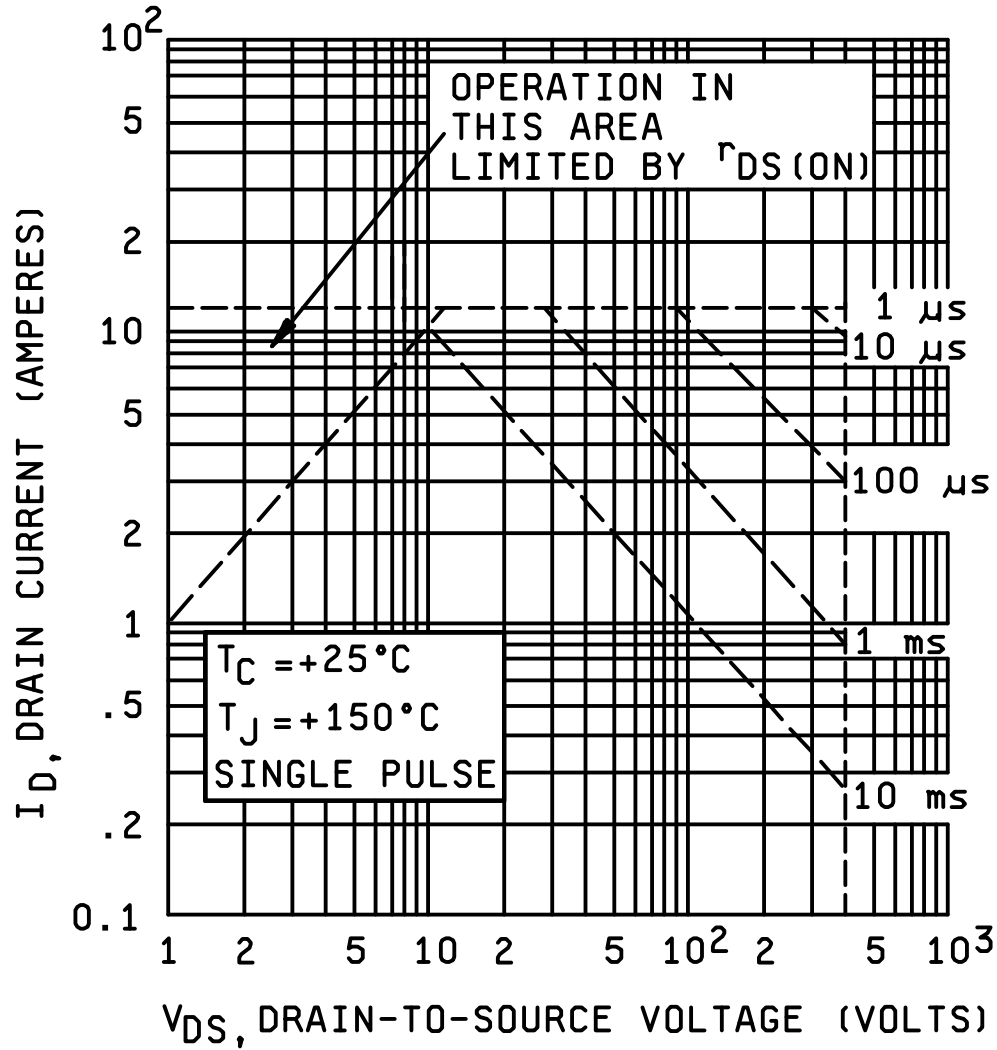

2N6800, 2N6800U

FIGURE 6. Maximum safe operating area - Continued.

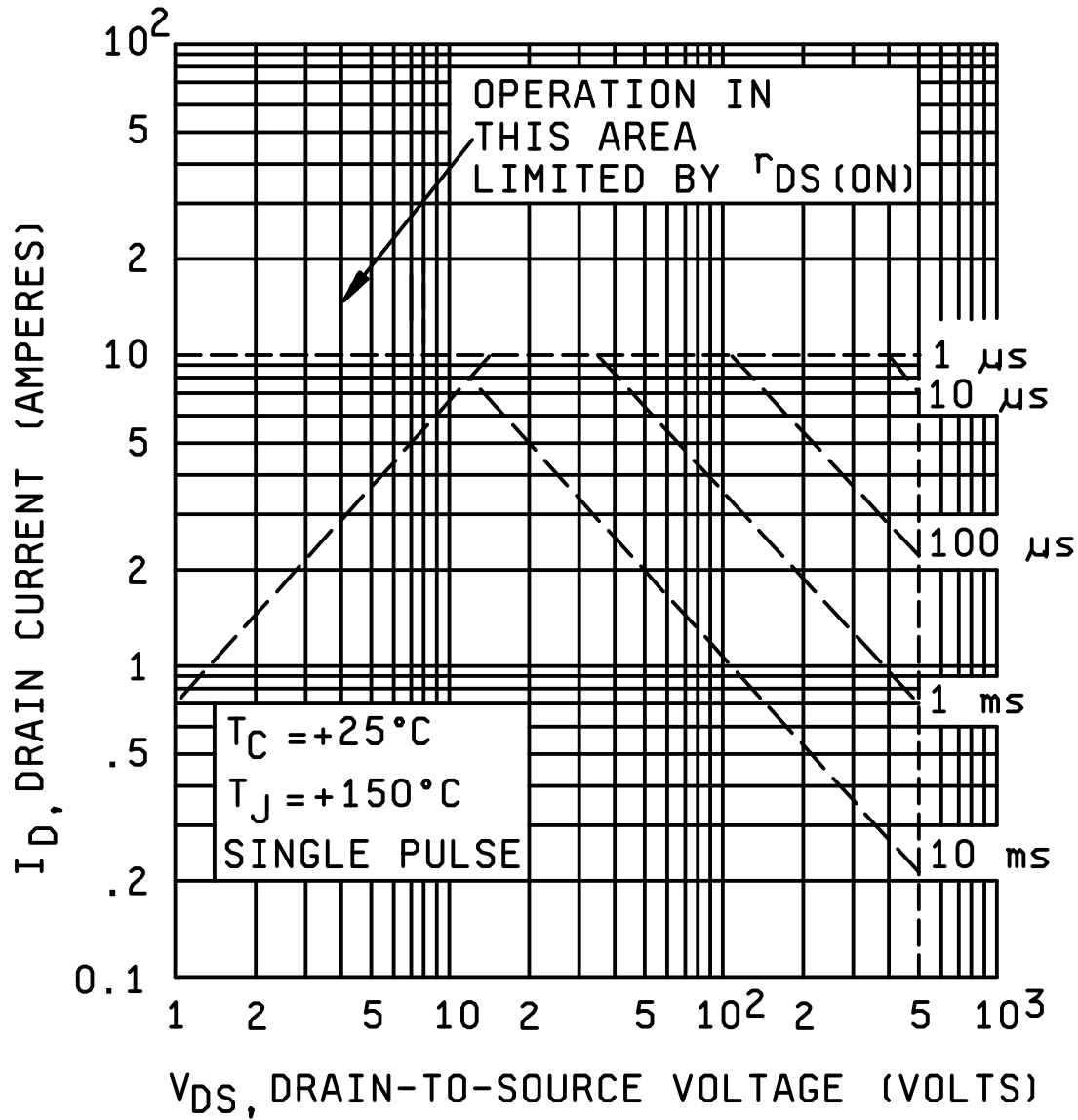

2N6802, 2N6802U

FIGURE 6. Maximum safe operating area - Continued.

5. PACKAGING

5.1 Packaging. For acquisition purposes, the packaging requirements shall be as specified in the contract or order (see 6.2). When actual packaging of material is to be performed by DoD personnel, these personnel need to contact the responsible packaging activity to ascertain requisite packaging requirements. Packaging requirements are maintained by the Inventory Control Points' packaging activity within the Military Department or Defense Agency, or within the Military Departments' System Command. Packaging data retrieval is available from the managing Military Departments' or Defense Agency's automated packaging files, CD-ROM products, or by contacting the responsible packaging activity.

5.2 Marking. Unless otherwise specified (see 6.2), marking shall be in accordance with MIL-PRF-19500.

6. NOTES

(This section contains information of a general or explanatory nature that may be helpful, but is not mandatory.)

6.1 Notes. The notes specified in MIL-PRF-19500 are applicable to this specification.

6.2 Cross-reference and complement list. Parts from this specification may be used to replace the following commercial Part or Identifying Number (PIN). The term PIN is equivalent to the term part number which was previously used in this specification.

Preferred types ^{1/}	Commercial types
2N6796	IRFF130, IRFF131, IRFF132, IRFF133
2N6798	IRFF230, IRFF231, IRFF232, IRFF233
2N6800	IRFF330, IRFF331, IRFF332, IRFF333
2N6802	IRFF430, IRFF431, IRFF432, IRFF433
2N6796U	IRFE130, IRFE131, IRFE132, IRFE133
2N6798U	IRFE230, IRFE231, IRFE232, IRFE233
2N6800U	IRFE330, IRFE331, IRFE332, IRFE333
2N6802U	IRFE430, IRFE431, IRFE432, IRFE433

^{1/} Prefixes are JAN, JANTX, JANTXV, or JANS

6.3 Acquisition requirements. Acquisition documents should specify the following:

- a. Issue of DODISS to be cited in the solicitation (see 2.1.1 and 2.2).
- b. The lead finish as specified (see 3.3.1).
- c. For die acquisition, specify the JANHC or JANKC letter version (see figure 3).
- d. Type designation and quality assurance level.

6.4 Suppliers of JANHC and JANKC die. The qualified die suppliers with the applicable letter version (example, JANHCA2N6802) will be identified on the QPL.

6.5 Qualification. With respect to products requiring qualification, awards will be made only for products which are, at the time of award of contract, qualified for inclusion in Qualified Products List QPL-19500 whether or not such products have actually been so listed by that date. The attention of the contractors is called to these requirements, and manufacturers are urged to arrange to have the products that they propose to offer to the Federal Government tested for qualification in order that they may be eligible to be awarded contracts or purchase orders for the products covered by this specification. Information pertaining to qualification of products may be obtained from Defense Supply Center Columbus, DSCC-VQE, Columbus, OH 43216.

6.6 Changes from previous issue. Marginal notations are not used in this revision to identify changes with respect to the previous issue due to the extensiveness of the changes.

MIL-PRF-19500/557F

CONCLUDING MATERIAL

Custodians:

Army - CR
Navy - EC
Air Force - 17

Preparing activity:
DLA - CC

(Project 5961-1928)

Review activities:

Army - AR, MI, SM
Navy - AS, CG, MC
Air Force - 19, 70, 80, 85

STANDARDIZATION DOCUMENT IMPROVEMENT PROPOSAL

INSTRUCTIONS

1. The preparing activity must complete blocks 1, 2, 3, and 8. In block 1, both the document number and revision letter should be given.
2. The submitter of this form must complete blocks 4, 5, 6, and 7.
3. The preparing activity must provide a reply within 30 days from receipt of the form.

NOTE: This form may not be used to request copies of documents, nor to request waivers, or clarification of requirements on current contracts. Comments submitted on this form do not constitute or imply authorization to waive any portion of the referenced document(s) or to amend contractual requirements.

I RECOMMEND A CHANGE:

1. DOCUMENT NUMBER
MIL-PRF-19500/557F

2. DOCUMENT DATE
(YYMMDD) 97/12/09

3. DOCUMENT TITLE

4. NATURE OF CHANGE (Identify paragraph number and include proposed rewrite, if possible. Attach extra sheets as needed.)

5. REASON FOR RECOMMENDATION

6. SUBMITTER

a. NAME (Last, First, Middle initial)

b. ORGANIZATION

c. ADDRESS (Include Zip Code)

d. TELEPHONE (Include Area Code)
(1) Commercial

(2) AUTOVON
(If applicable)

7. DATE SUBMITTED
(YYMMDD)

8. PREPARING ACTIVITY

a. NAME
Alan Barone

b. TELEPHONE (Include Area Code)
(1) Commercial (2) AUTOVON
614-692-0510 850-0510

c. ADDRESS (Include Zip Code)
Defense Supply Center Columbus
ATTN: DSCC-VAT
Columbus, OH 43216-5000

IF YOU DO NOT RECEIVE A REPLY WITHIN 45 DAYS, CONTACT:
Defense Quality and Standardization Office
5203 Leesburg Pike, Suite 1403,
Falls Church, VA 22041-3466
Telephone (703) 756-2340 AUTOVON 289-2340