

TIL194, TIL195, TIL196, TIL194X, TIL195X, TIL196X
 TIL194A, TIL195A, TIL196A, TIL194AX, TIL195AX, TIL196AX
 TIL194B, TIL195B, TIL196B, TIL194BX, TIL195BX, TIL196BX

**HIGH DENSITY A.C. INPUT
 PHOTOTRANSISTOR OPTICALLY
 COUPLED ISOLATORS**



APPROVALS

- UL recognised, File No. E91231
- 'X' SPECIFICATION APPROVALS
- VDE 0884 in 3 available lead form:
 - STD
 - G form
 - SMD approved to CECC 00802
- TIL194X/AX/BX Certified to EN60950 by the following Test Bodies :-
 - Nemko - Certificate No. P01102465
 - Fimko - Certificate No. FI18162
 - Semko - Reference No. 0202041/01-25
 - Demko - Certificate No. 311161-01
- TIL194X/AX/BX : BSI approved
 - Certificate No. 8001

DESCRIPTION

The TIL194, TIL195, TIL196 series of optically coupled isolators consist of two infrared light emitting diodes connected in inverse parallel and NPN silicon photo transistors in space efficient dual in line plastic packages.

FEATURES

- Options :-
 - 10mm lead spread - add G after part no.
 - Surface mount - add SM after part no.
 - Tape & reel - add SMT & R after part no.
- High Isolation Voltage (5.3kV_{RMS}, 7.5kV_{PK})
- AC or polarity insensitive input
- All electrical parameters 100% tested
- Custom electrical selections available

APPLICATIONS

- Computer terminals
- Industrial systems controllers
- Telephone sets, Telephone exchangers
- Signal transmission between systems of different potentials and impedances

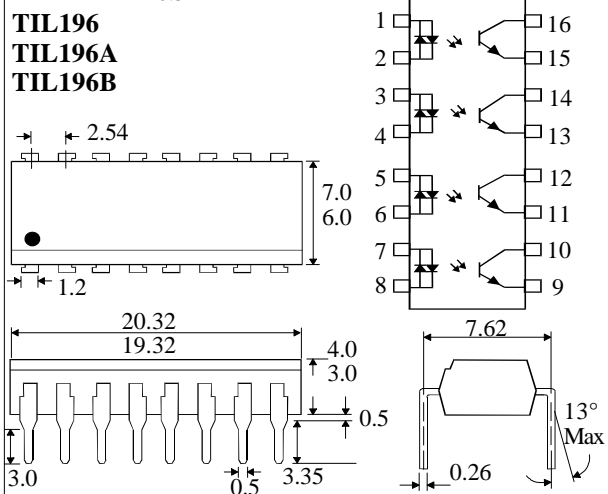
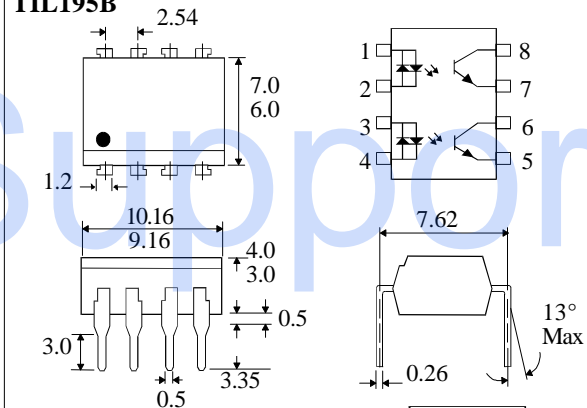
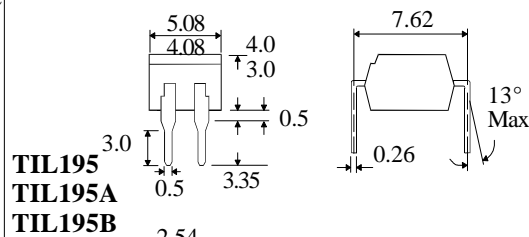
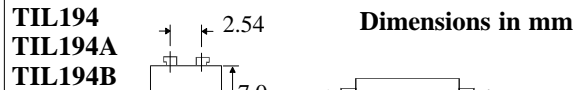
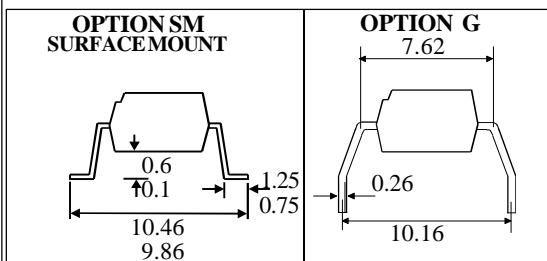

ISOCOM COMPONENTS LTD
 Unit 25B, Park View Road West,
 Park View Industrial Estate, Brenda Road
 Hartlepool, Cleveland, TS25 1YD
 Tel: (01429) 863609 Fax :(01429) 863581

ABSOLUTE MAXIMUM RATINGS

(25°C unless otherwise specified)

Storage Temperature	_____	-55°C to + 125°C
Operating Temperature	_____	-30°C to +100°C
Lead Soldering Temperature		
(1/16 inch (1.6mm) from case for 10 secs)		260°C

INPUT DIODE

Forward Current	_____	± 50mA
Power Dissipation	_____	70mW

OUTPUT TRANSISTOR

Collector-emitter Voltage BV_{CEO}	_____	35V
Emitter-collector Voltage BV_{ECO}	_____	6V
Power Dissipation	_____	150mW

POWER DISSIPATION

Total Power Dissipation	_____	200mW
(derate linearly 2.67mW/°C above 25°C)		

ELECTRICAL CHARACTERISTICS ($T_A = 25^\circ\text{C}$ Unless otherwise noted)

PARAMETER		MIN	TYP	MAX	UNITS	TEST CONDITION
Input	Forward Voltage (V_F)		1.2	1.4	V	$I_F = \pm 20\text{mA}$
Output	Collector-emitter Breakdown (BV_{CEO}) (Note 2)	35			V	$I_C = 0.5\text{mA}$
	Emitter-collector Breakdown (BV_{ECO})	6			V	$I_E = 100\mu\text{A}$
	Collector-emitter Dark Current (I_{CEO})			100	nA	$V_{CE} = 20\text{V}$
Coupled	Current Transfer Ratio (CTR) (Note 2) TIL194, TIL195, TIL196	20			%	$\pm 5\text{mA}I_F, 5\text{V} V_{CE}$
	TIL194A, TIL195A, TIL196A	50			%	
	TIL194B, TIL195B, TIL196B	100			%	
	Collector-Emitter Saturation Voltage $V_{CE(SAT)}$			0.4	V	$\pm 5\text{mA}I_F, 1\text{mA}I_C$
	Input to Output Isolation Voltage V_{ISO}	5300 7500			V_{RMS} V_{PK}	See note 1 See note 1
	Input-output Isolation Resistance R_{ISO}	5×10^{10}			Ω	$V_{IO} = 500\text{V}$ (note 1)
	Response Time (Rise), tr		4		μs	$V_{CE} = 2\text{V},$ $I_C = 2\text{mA}, R_L = 100\Omega$
Response Time (Fall), tf		3		μs		

Note 1 Measured with input leads shorted together and output leads shorted together.

Note 2 Special Selections are available on request. Please consult the factory.

Collector Power Dissipation vs. Ambient Temperature

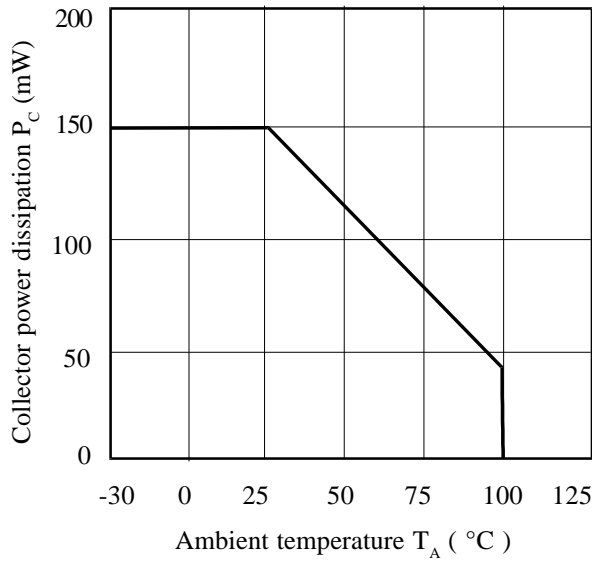

Collector Current vs. Low Collector-emitter Voltage

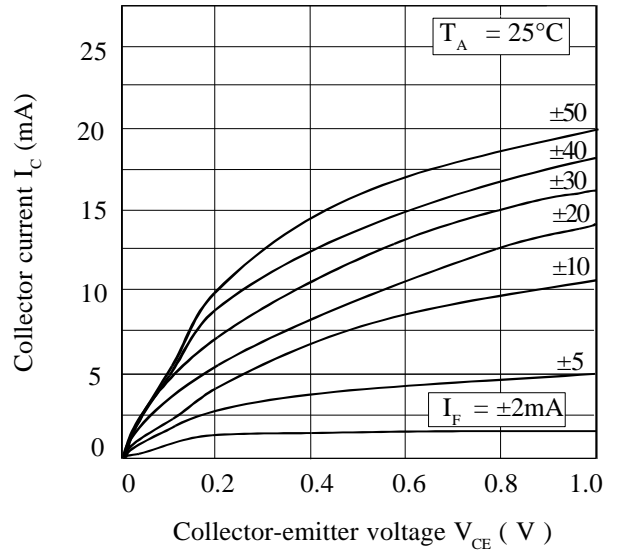

Forward Current vs. Ambient Temperature

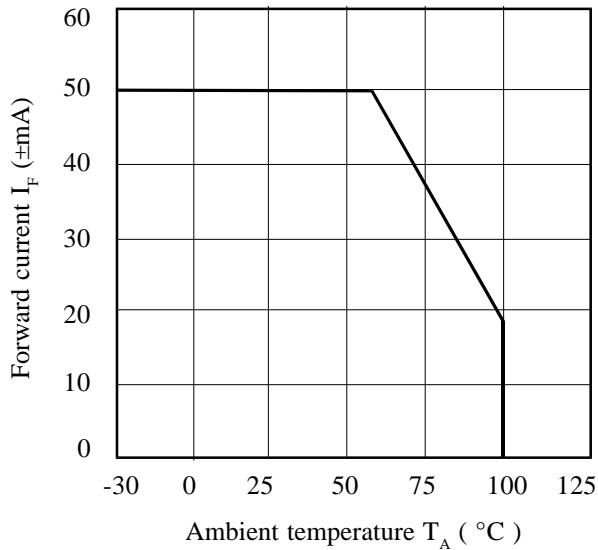

Collector Current vs. Collector-emitter Voltage

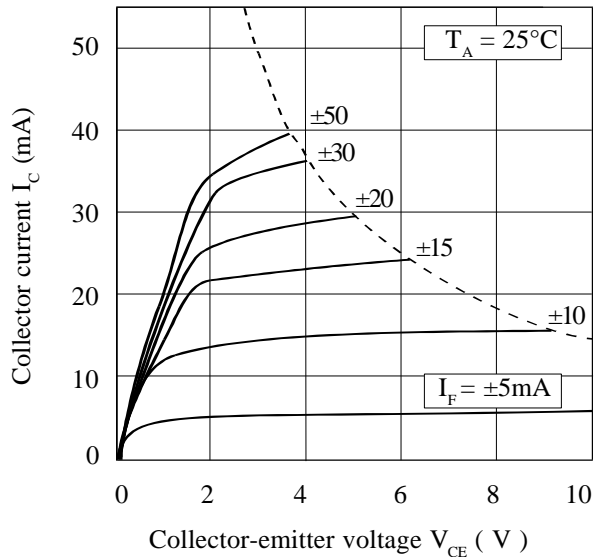

Collector-emitter Saturation Voltage vs. Ambient Temperature

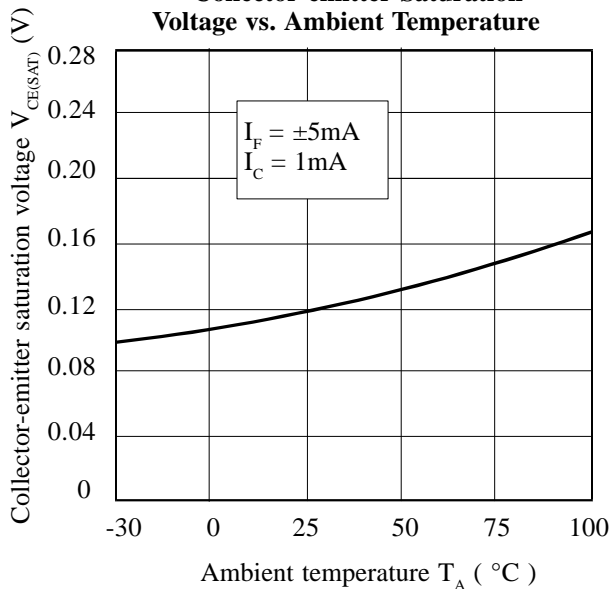

Current Transfer Ratio vs. Forward Current

