

Features

- Planar Die Construction
- 350mW Power Dissipation on FR-4 PCB
- General Purpose, Medium Current
- Ideally Suited for Automated Assembly Processes
- **Totally Lead-Free & Fully RoHS Compliant (Notes 1 & 2)**
- **Halogen and Antimony Free. "Green" Device (Notes 3 & 4)**
- **Qualified to AEC-Q101 Standards for High Reliability**

Mechanical Data

- Case: SOT23
- Case Material: Molded Plastic, "Green" Molding Compound. UL Flammability Classification Rating 94V-0
- Moisture Sensitivity: Level 1 per J-STD-020
- Terminal Connections: See Diagram
- Terminals: Matte Tin Finish annealed over Alloy 42 leadframe (Lead Free Plating). Solderable per MIL-STD-202, Method 208 e3
- Weight: 0.008 grams (approximate)

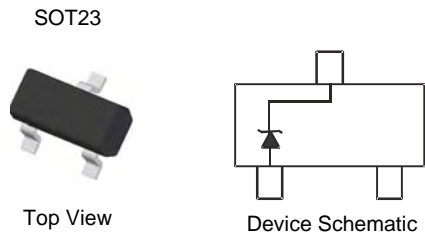

Ordering Information (Notes 5 & 6)

Device	Qualification	Packaging	Shipping
(Type Number)-7-F*	Commercial	SOT23	3000/Tape & Reel
(Type Number)Q-7-F*	Automotive	SOT23	3000/Tape & Reel

* Add "-7-F" to the appropriate type number in Electrical Characteristics Table from Page 2. Example: 6.2V Zener = MMBZ5234B-7-F.

- Notes:
1. No purposely added lead. Fully EU Directive 2002/95/EC (RoHS) & 2011/65/EU (RoHS 2) compliant.
 2. See <http://www.diodes.com> for more information about Diodes Incorporated's definitions of Halogen- and Antimony-free, "Green" and Lead-free.
 3. Halogen- and Antimony-free "Green" products are defined as those which contain <900ppm bromine, <900ppm chlorine (<1500ppm total Br + Cl) and <1000ppm antimony compounds.
 4. Product manufactured with Date Code OW (week 42, 2009) and newer are built with Green Molding Compound. Product manufactured prior to Date Code OW are built with Non-Green Molding Compound and may contain Halogens or Sb₂O₃ Fire Retardants.
 5. For Packaging Details, go to our website at <http://www.diodes.com>.
 6. Selected voltages are available on 13" reels (10,000 devices per reel). Add "-13-F" to the appropriate type number in Electrical Characteristics Table from Page 2. Example: 6.2V Zener = MMBZ5234B-13-F. Please contact your Diodes Inc. sales representative for availability.

Marking Information

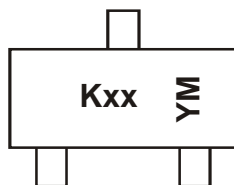

K = SAT (Shanghai Assembly / Test site)
 xx = Product Type Marking Code
 See Electrical Characteristics Table
 YM = Date Code Marking
 Y = Year (ex: Z = 2012)
 M = Month (ex: 9 = September)

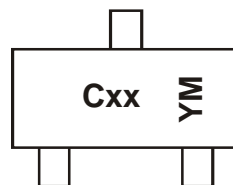

C = CAT (Chengdu Assembly / Test site)
 xx = Product Type Marking Code
 See Electrical Characteristics Table
 YM = Date Code Marking
 Y = Year (ex: Z = 2012)
 M = Month (ex: 9 = September)

Date Code Key

Year	1998	...	2002	2003	2004	...	2010	2011	2012	2013	2014	2015	2016	2017	2018
Code	J	...	N	P	R	...	X	Y	Z	A	B	C	D	E	F

Month	Jan	Feb	Mar	Apr	May	Jun	Jul	Aug	Sep	Oct	Nov	Dec
Code	1	2	3	4	5	6	7	8	9	O	N	D

Maximum Ratings (@T_A = +25°C, unless otherwise specified.)

Characteristic	Symbol	Value	Unit
Forward Voltage @ I _F = 10mA	V _F	0.9	V

Thermal Characteristics

Characteristic	Symbol	Value	Unit
Power Dissipation (Note 7)	P _D	350	mW
Thermal Resistance, Junction to Ambient Air (Note 7)	R _{θJA}	357	°C/W
Operating and Storage Temperature Range	T _J , T _{STG}	-65 to +150	°C

Notes: 7. Mounted on FR4 PC Board with recommended pad layout which can be found on our website at <http://www.diodes.com>.

Electrical Characteristics (@T_A = +25°C, unless otherwise specified.)

Type Number	Type Code	Zener Voltage Range (Note 8)				Maximum Zener Impedance f = 1kHz		Maximum Reverse Leakage Current (Note 8)	
		V _Z @ I _{ZT}			I _{ZT}	Z _{KT} @ I _{ZT}	Z _{ZK} @ I _{ZK} = 0.25mA	I _R	@ V _R
		Nom (V)	Min (V)	Max (V)	mA	Ω		μA	V
MMBZ5221B	C1	2.4	2.28	2.52	20	30	1200	100	1.0
MMBZ5222B	C2	2.5	2.38	2.63	20	30	1200	100	1.0
MMBZ5223B	C3	2.7	2.57	2.84	20	30	1300	75	1.0
MMBZ5225B	C5	3.0	2.85	3.15	20	30	1600	50	1.0
MMBZ5226B	G1	3.3	3.14	3.47	20	28	1600	25	1.0
MMBZ5227B	G2	3.6	3.42	3.78	20	24	1700	15	1.0
MMBZ5228B	G3	3.9	3.71	4.10	20	23	1900	10	1.0
MMBZ5229B	G4	4.3	4.09	4.52	20	22	2000	5.0	1.0
MMBZ5230B	G5	4.7	4.47	4.94	20	19	1900	5.0	2.0
MMBZ5231B	E1	5.1	4.85	5.36	20	17	1600	5.0	2.0
MMBZ5232B	E2	5.6	5.32	5.88	20	11	1600	5.0	3.0
MMBZ5233B	E3	6.0	5.70	6.30	20	7	1600	5.0	3.5
MMBZ5234B	E4	6.2	5.89	6.51	20	7	1000	5.0	4.0
MMBZ5235B	E5	6.8	6.46	7.14	20	5	750	3.0	5.0
MMBZ5236B	F1	7.5	7.13	7.88	20	6	500	3.0	6.0
MMBZ5237B	F2	8.2	7.79	8.61	20	8	500	3.0	6.5
MMBZ5238B	F3	8.7	8.27	9.14	20	8	600	3.0	6.5
MMBZ5239B	F4	9.1	8.65	9.56	20	10	600	3.0	7.0
MMBZ5240B	F5	10	9.50	10.50	20	17	600	3.0	8.0
MMBZ5241B	H1	11	10.45	11.55	20	22	600	2.0	8.4
MMBZ5242B	H2	12	11.40	12.60	20	30	600	1.0	9.1
MMBZ5243B	H3	13	12.35	13.65	9.5	13	600	0.5	9.9
MMBZ5244B	H4	14	13.30	14.70	9.0	15	600	0.1	10
MMBZ5245B	H5	15	14.25	15.75	8.5	16	600	0.1	11
MMBZ5246B	J1	16	15.20	16.80	7.8	17	600	0.1	12
MMBZ5248B	J3	18	17.10	18.90	7.0	21	600	0.1	14
MMBZ5250B	J5	20	19.00	21.00	6.2	25	600	0.1	15
MMBZ5251B	K1	22	20.90	23.10	5.6	29	600	0.1	17
MMBZ5252B	K2	24	22.80	25.20	5.2	33	600	0.1	18
MMBZ5254B	K4	27	25.65	28.35	5.0	41	600	0.1	21
MMBZ5255B	K5	28	26.60	29.40	4.5	44	600	0.1	21
MMBZ5256B	M1	30	28.50	31.50	4.2	49	600	0.1	23
MMBZ5257B	M2	33	31.35	34.65	3.8	58	700	0.1	25
MMBZ5258B	M3	36	34.20	37.80	3.4	70	700	0.1	27
MMBZ5259B	M4	39	37.05	40.95	3.2	80	800	0.1	30

Notes: 8. Short duration pulse test used to minimize self-heating effect.

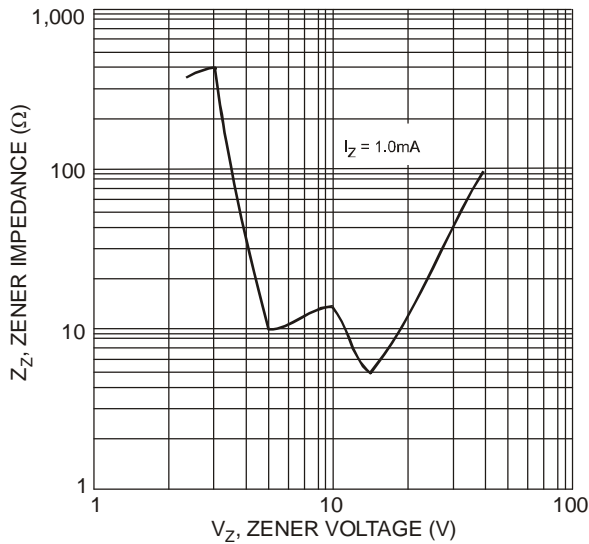
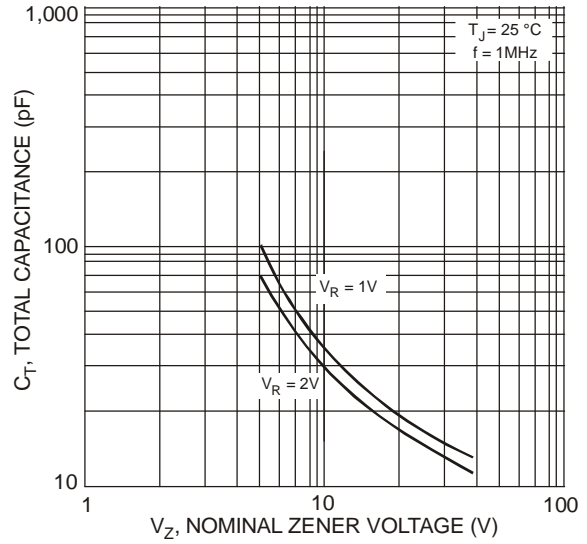
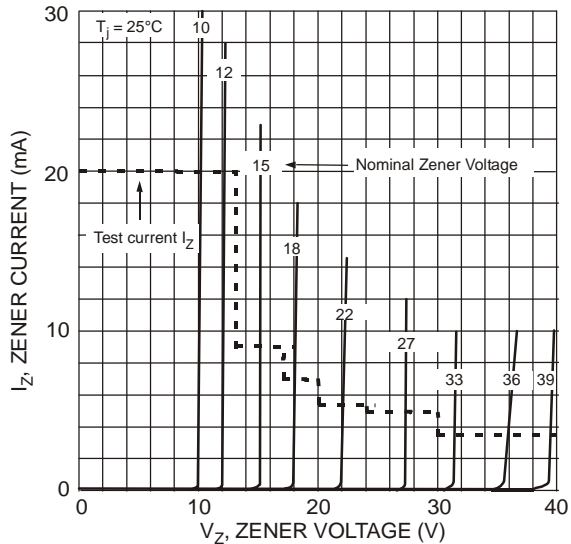
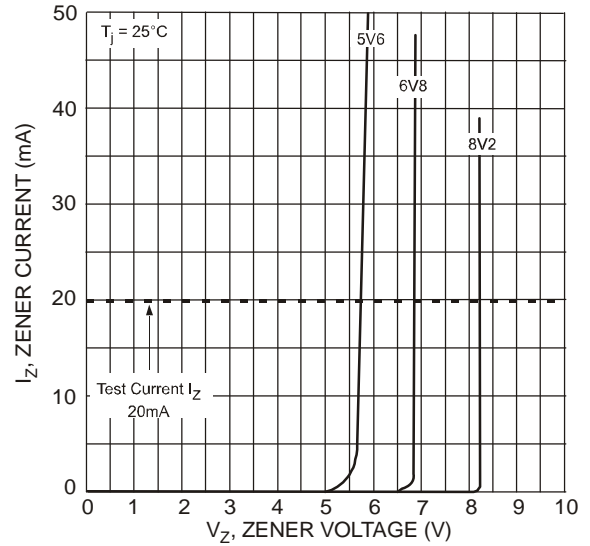
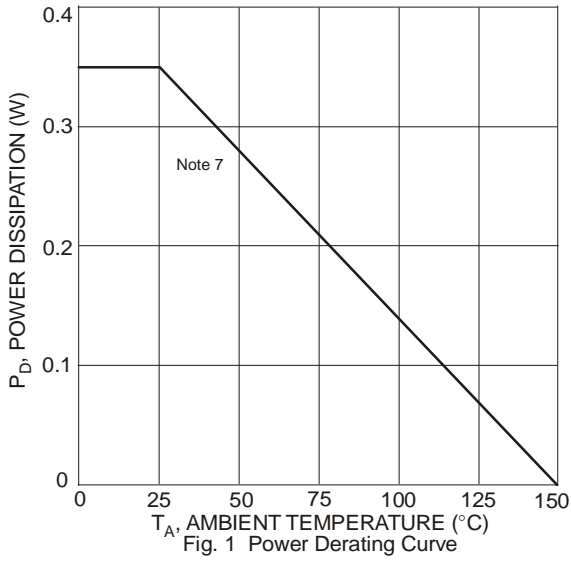

Fig. 2 Typical Zener Breakdown Characteristics

Fig. 3 Typical Zener Breakdown Characteristics

Fig. 4 Typical Total Capacitance vs. Nominal Zener Voltage

Fig. 5 Typical Zener Impedance Characteristics

Package Outline Dimensions

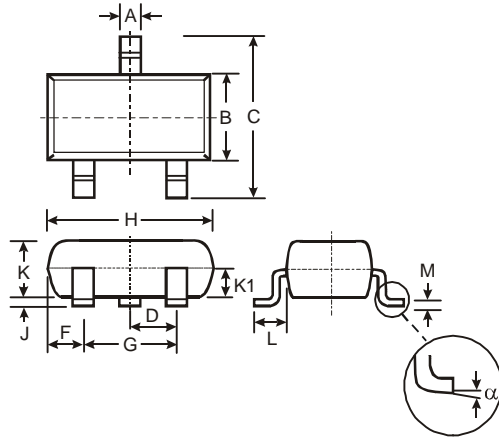

SOT23			
Dim	Min	Max	Typ
A	0.37	0.51	0.40
B	1.20	1.40	1.30
C	2.30	2.50	2.40
D	0.89	1.03	0.915
F	0.45	0.60	0.535
G	1.78	2.05	1.83
H	2.80	3.00	2.90
J	0.013	0.10	0.05
K	0.903	1.10	1.00
K1	-	-	0.400
L	0.45	0.61	0.55
M	0.085	0.18	0.11
α	0°	8°	-

All Dimensions in mm

Suggested Pad Layout

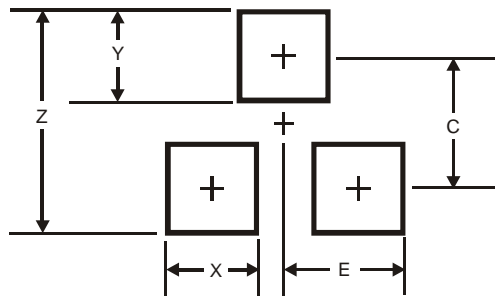

Dimensions	Value (in mm)
Z	2.9
X	0.8
Y	0.9
C	2.0
E	1.35

IMPORTANT NOTICE

DIODES INCORPORATED MAKES NO WARRANTY OF ANY KIND, EXPRESS OR IMPLIED, WITH REGARDS TO THIS DOCUMENT, INCLUDING, BUT NOT LIMITED TO, THE IMPLIED WARRANTIES OF MERCHANTABILITY AND FITNESS FOR A PARTICULAR PURPOSE (AND THEIR EQUIVALENTS UNDER THE LAWS OF ANY JURISDICTION).

Diodes Incorporated and its subsidiaries reserve the right to make modifications, enhancements, improvements, corrections or other changes without further notice to this document and any product described herein. Diodes Incorporated does not assume any liability arising out of the application or use of this document or any product described herein; neither does Diodes Incorporated convey any license under its patent or trademark rights, nor the rights of others. Any Customer or user of this document or products described herein in such applications shall assume all risks of such use and will agree to hold Diodes Incorporated and all the companies whose products are represented on Diodes Incorporated website, harmless against all damages.

Diodes Incorporated does not warrant or accept any liability whatsoever in respect of any products purchased through unauthorized sales channel. Should Customers purchase or use Diodes Incorporated products for any unintended or unauthorized application, Customers shall indemnify and hold Diodes Incorporated and its representatives harmless against all claims, damages, expenses, and attorney fees arising out of, directly or indirectly, any claim of personal injury or death associated with such unintended or unauthorized application.

Products described herein may be covered by one or more United States, international or foreign patents pending. Product names and markings noted herein may also be covered by one or more United States, international or foreign trademarks.

LIFE SUPPORT

Diodes Incorporated products are specifically not authorized for use as critical components in life support devices or systems without the express written approval of the Chief Executive Officer of Diodes Incorporated. As used herein:

A. Life support devices or systems are devices or systems which:

1. are intended to implant into the body, or
2. support or sustain life and whose failure to perform when properly used in accordance with instructions for use provided in the labeling can be reasonably expected to result in significant injury to the user.

B. A critical component is any component in a life support device or system whose failure to perform can be reasonably expected to cause the failure of the life support device or to affect its safety or effectiveness.

Customers represent that they have all necessary expertise in the safety and regulatory ramifications of their life support devices or systems, and acknowledge and agree that they are solely responsible for all legal, regulatory and safety-related requirements concerning their products and any use of Diodes Incorporated products in such safety-critical, life support devices or systems, notwithstanding any devices- or systems-related information or support that may be provided by Diodes Incorporated. Further, Customers must fully indemnify Diodes Incorporated and its representatives against any damages arising out of the use of Diodes Incorporated products in such safety-critical, life support devices or systems.

Copyright © 2012, Diodes Incorporated

www.diodes.com