

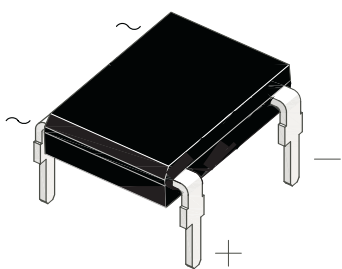
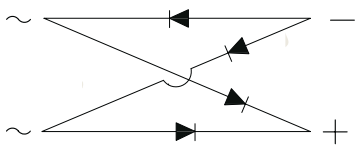

1.0 Amp. Miniature Glass Passivated Single-Phase Bridge Rectifier

<p>DFM</p>  	<p>Voltage 200 V to 1000 V</p>	<p>Current 1.0 Amp. at 40°C</p>	
	<p>FEATURES</p> <ul style="list-style-type: none"> • Ideal for automated insertion • High forward surge current capability • Ideal for printed circuit boards • Solder dip 260°C, 10s • Component in accordance to RoHS 2002/95/EC and WEEE 2002/96/EC • Meets MSL level 1, per J-STD-020, LF maximum peak of 250° C 		  RoHS COMPLIANT
	<p>MECHANICAL DATA</p> <ul style="list-style-type: none"> • Case: DFM <p>Epoxy meets UL 94V-0 flammability rating.</p> <ul style="list-style-type: none"> • Polarity: As marked on body. • Terminals: Matte tin plated leads, solderable per MIL-STD-750 Method 2026, J-STD-002 and JESD22-B102. Consumer grade, meets JESD 201 class 1A whisker test. 		
	<p>TYPICAL APPLICATIONS</p> <p>Used in ac-to-dc bridge full wave rectification for SMPS, lighting ballaster, adapter, battery charger, home appliances, office equipment, and telecommunication applications..</p>		

Maximum Ratings and Electrical Characteristics at 25°C

		DF02M	DF04M	DF06M	DF08M	DF10M
	Marking code	DF02M	DF04M	DF06M	DF08M	DF10M
V_{RRM}	Peak recurrent reverse voltage (V)	200	400	600	800	1000
V_{RMS}	Maximum RMS voltage (V)	140	280	420	560	700
V_R	Recommended Input Voltage (V)	80	125	250	380	500
$I_{F(AV)}$	Forward current at $T_{amb} = 40^\circ C$ R Load L Load	1.0 A 0.8 A				
I_{FRM}	Recurrent peak forward current	10 A				
I_{FSM}	8.3 ms. peak forward surge current (Jedec Method)	50 A				
I^2t	I^2t value for fusing ($t = 8.3$ ms)	10 A ² sec				
T_j	Operating temperature range	- 55 to + 150 °C				
T_{stg}	Storage temperature range	- 55 to + 150 °C				

Electrical Characteristics at $T_{amb} = 25^\circ C$

V_F	Max. forward voltage drop at $I_F = 1$ A	1.1 V
I_R	Max. reverse current per element V_{RRM} d.c. and $T_a = 25^\circ C$ and $T_a = 125^\circ C$	10 μA 500 μA
$R_{th(j-a)}$	Maximum thermal resistance junction to ambient (*)	65 °C/W

(*) NOTE: Thermal Resistance from junction to ambient mounted on P.C. Board with 13 mm. sq. Copper Pads

1.0 Amp. Miniature Glass Passivated Single-Phase Bridge Rectifier

Ordering information

PREFERRED P/N	PACKAGE CODE	DELIVERY MODE	BASE QUANTITY	UNIT WEIGHT (g)
DF06M TU	TU	TUBE	5,000	0.416

Package Outline Dimensions: (mm) DFM

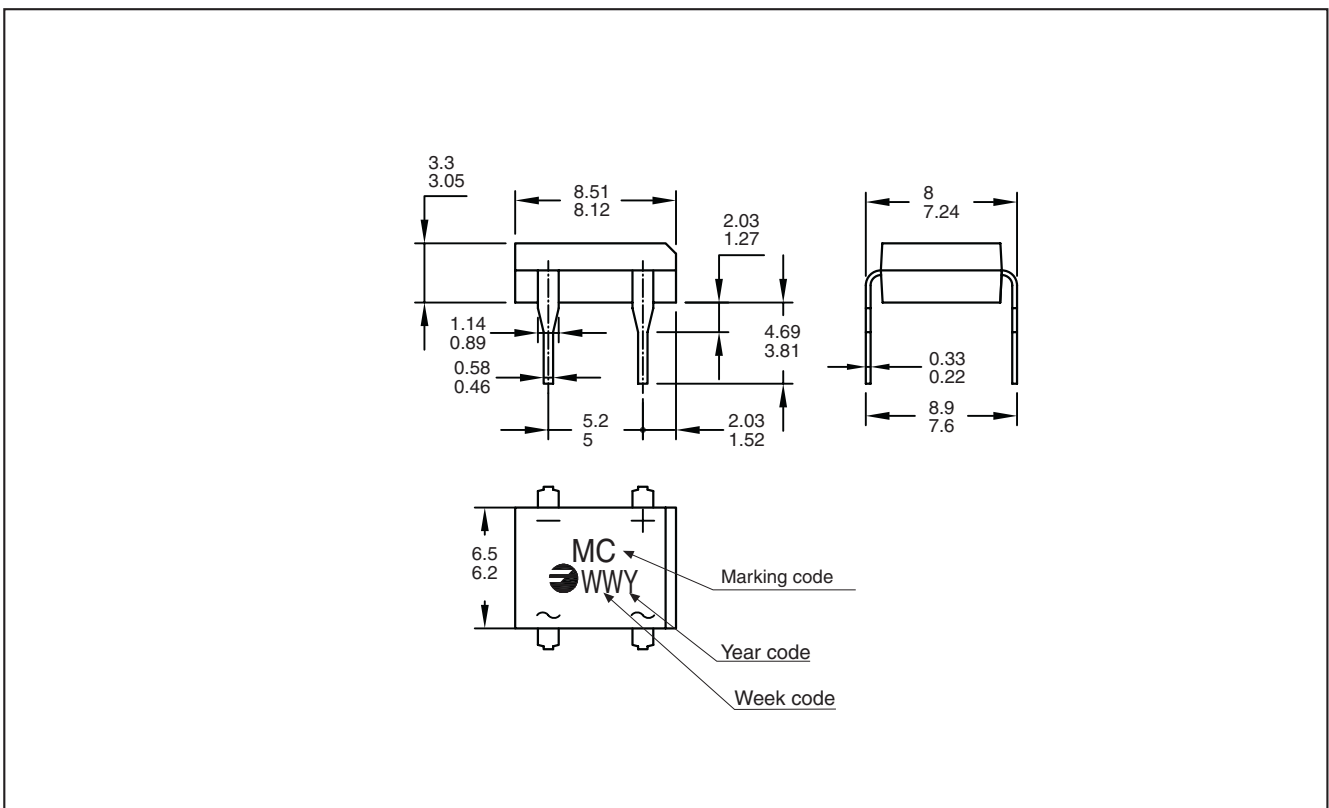

1.0 Amp. Miniature Glass Passivated Single-Phase Bridge Rectifier

Ratings and Characteristics (Ta 25 °C unless otherwise noted)

TYPICAL FORWARD CHARACTERISTIC

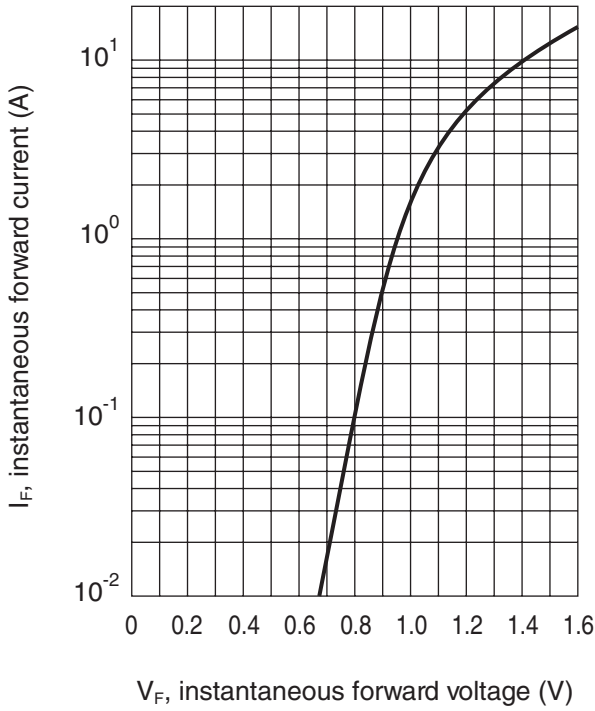

FORWARD CURRENT DERATING CURVE

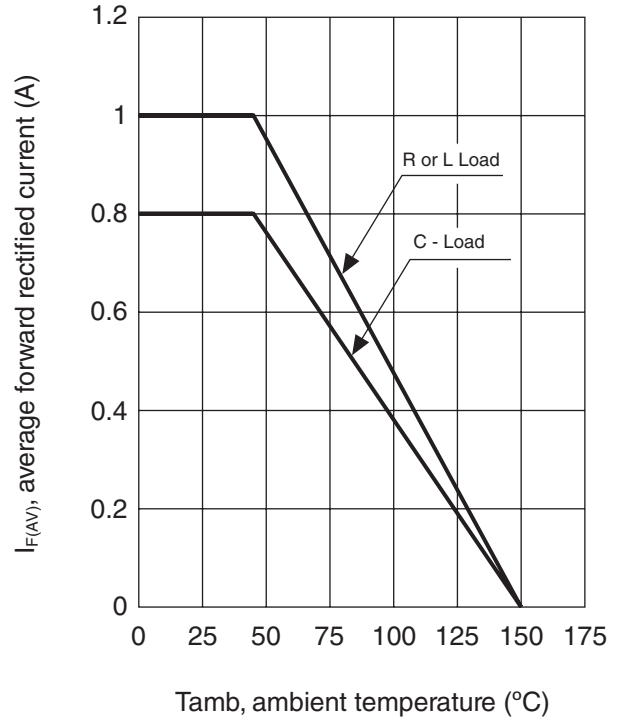

MAXIMUM NON-REPETITIVE PEAK FORWARD SURGE CURRENT

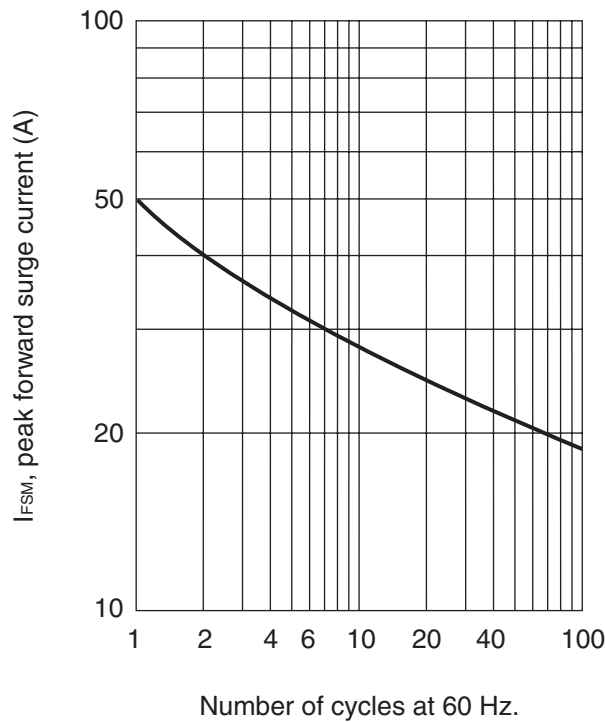

1.0 Amp. Miniature Glass Passivated Single-Phase Bridge Rectifier

Disclaimer

All product, product specifications and data are subject to change without notice to improve reliability, function or design or otherwise.

Fagor Electrónica, S.Coop., its affiliates, agents, and employees, and all persons acting on its or their behalf (collectively, "Fagor"), disclaim any and all liability for any errors, inaccuracies or incompleteness contained in any datasheet or in any other disclosure relating to any product.

Fagor makes no warranty, representation or guarantee regarding the suitability of the products for any particular purpose or the continuing production of any product. To the maximum extent permitted by applicable law, Fagor disclaims (i) any and all liability arising out of the application or use of any product, (ii) any and all liability, including without limitation special, consequential or incidental damages, and (iii) any and all implied warranties, including warranties of fitness for particular purpose, non-infringement and merchantability.

Statements regarding the suitability of products for certain types of applications are based on Fagor's knowledge of typical requirements that are often placed on Fagor products in generic applications. Such statements are not binding statements about the suitability of products for a particular application. It is the customer's responsibility to validate that a particular product with the properties described in the product specification is suitable for use in a particular application. Parameters provided in datasheets and/or specifications may vary in different applications and performance may vary over time. All operating parameters, including typical parameters, must be validated for each customer application by the customer's technical experts. Product specifications do not expand or otherwise modify Fagor's terms and conditions of purchase, including but not limited to the warranty expressed therein.

Except as expressly indicated in writing, Fagor products are not designed for use in medical, life-saving, or life-sustaining applications or for any other application in which the failure of the Fagor product could result in personal injury or death. Customers using or selling Fagor products not expressly indicated for use in such applications do so at their own risk and agree to fully indemnify and hold Fagor and its distributors harmless from and against any and all claims, liabilities, expenses and damages arising or resulting in connection with such use or sale, including attorneys fees, even if such claim alleges that Fagor or its distributor was negligent regarding the design or manufacture of the part. Please contact authorized Fagor personnel to obtain written terms and conditions regarding products designed for such applications.

No license, express or implied, by estoppel or otherwise, to any intellectual property rights is granted by this document or by any conduct of Fagor, Product names and markings noted herein may be trademarks of their respective owners.