

# KL series

Locking power rocker switches



## DISTINCTIVE FEATURES

- One protected position
- Patented intuitive ergonomics
- Laser etched symbols
- Illuminated or non-illuminated
- Optionally sealed to IP69K



## ENVIRONMENTAL SPECIFICATIONS

- Sealing options :
  - K : IP68 to front panel components of switch only according to IEC 60529
  - Z : IP69K panel sealing according to DIN 40050-9
- Salt spray resistance : 96 hours according to IEC 512-6, test 11f
- Operating temperature : -40 °C to +85 °C (-40 °F to +185 °F)



## ELECTRICAL SPECIFICATIONS

- Current/voltage rating with resistive load :
  - Silver plated contacts :
    - A : 5 A 24 VDC, 100,000 cycles
    - 10 A 24 VDC, 10,000 cycles (terminals 6.35 x 0.8 only)
    - S : 20 A 12 V, 10,000 cycles (see "Build your part number")
  - Gold plated contacts (D) : 20 mA 12 V, 150,000 cycles
- Initial contact resistance : 10 mΩ max.
- Insulation resistance : 1,000 MΩ min. at 500 VDC
- Dielectric strength : 2,000 Vrms 50 Hz min. between terminals
- Mechanical life : 150,000 cycles min.



## GENERAL SPECIFICATIONS

- Mechanical life : 150,000 cycles min.
- Panel thickness : 0.8 mm to 4.6 mm
- Recommended panel thickness : between 2 mm and 3.5 mm

The company reserves the right to change specifications without notice.



# KL series

Locking power rocker switches



## MATERIALS

- Case : PA 6-6
- Actuator : ABS
- Unlocking actuator : ABS or elastomeric membrane
- Bezel : PA 6-6
- Contacts & terminals : brass, solid silver grain, silver plated (A or S) or brass, solid silver grain, gold plated (D)
- Contact roller : brass, nickel plated

APEM products may be recycled at end-of-life for the re-claiming of valuable metal components.



## SEALING

- Sealing is optional. To order a sealed product, complete the appropriate box of ordering format on the following pages.



## MATRIX MOUNTING

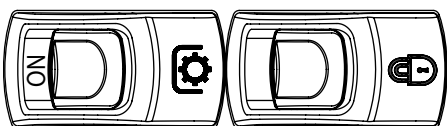
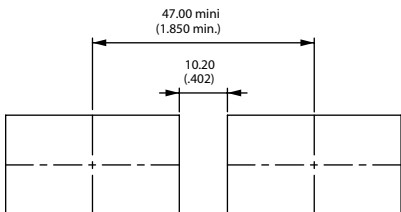
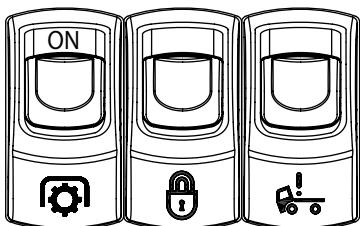
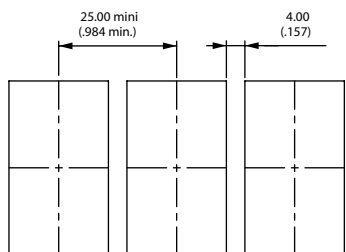

## PANEL CUT-OUT

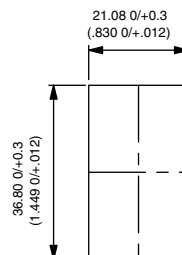

## SPECIFIC MATRIX MOUNTING FOR Z VERSION

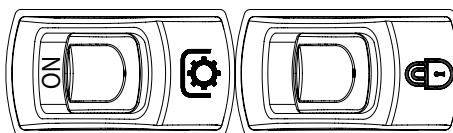
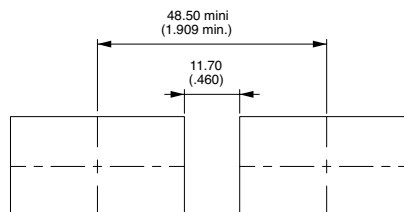
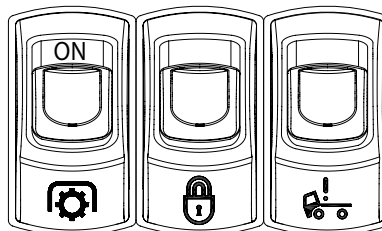
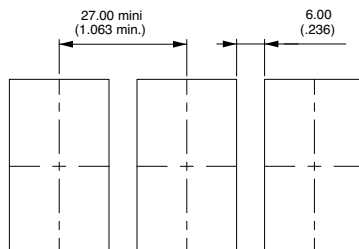



### ELECTRICAL FUNCTIONS AND CONNECTIONS

In the tables below, terminal connections as viewed from bottom of switch. Only the contact area is represented. For single pole models, only terminals 1, 2 and 3 are to be considered (not 6, 5, 4).

x = w/o terminal  
o = with terminal  
▲ = momentary

#### 2 POSITIONS

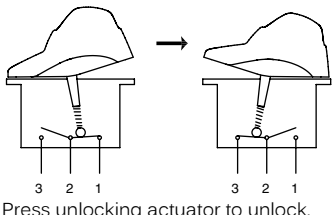

Function 1 * KL31-KL41		
Function 5 KL35 - KL45		
Function 6 KL36-KL46		

\* Function 1 : Only available for 6 terminal versions, illuminated versions only available with "A" wiring.

#### 3 POSITIONS

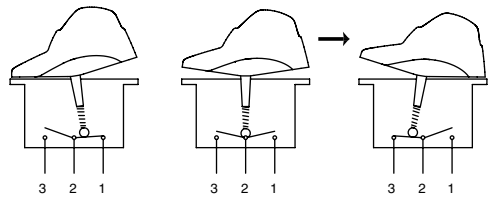

Function 7 KL37-KL47			
Function 8 KL38-KL48			
Function 9 KL39-KL49			
Function 4 KL44			
Function 4-1R KL44-1R			



### TERMINALS

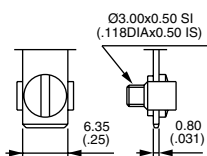

Screw

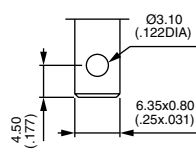

Solder lug / quick-connect

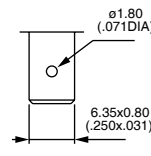

Normalized quick-connect 6.35x0.8

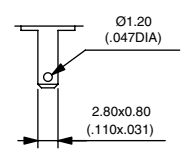

Normalized quick-connect 2.8x0.8

# KL series

Locking power rocker switches



## BUILD YOUR PART NUMBER

To order a complete product, fill in all the boxes of the following order guide.

### CASE + LEADS



#### SERIES

KL

#### POLES

- 3** Single pole
- 4** Double pole

#### ELECTRICAL FUNCTIONS

<b>1</b>	ON	-	OFF
<b>4</b>	ON	ON	ON
<b>4-1R</b>	ON	ON	MOM
<b>5</b>	MOM	-	ON
<b>6</b>	ON	-	ON
<b>7</b>	MOM	OFF	MOM
<b>8</b>	ON	OFF	MOM
<b>9</b>	ON	OFF	ON

Function 1 only for 6-terminal versions.  
Functions 5 and 6 cannot be combined with "H" wiring.

#### CONTACTS

<b>A</b>	Silver
<b>D</b>	Gold plated
<b>S</b>	Silver 20 A***

#### SEALING

<b>X</b>	No
<b>K</b>	IP68
<b>Z</b>	IP69K

#### LEDS

<b>X</b>	None	<b>F</b>	LED 12 V yellow
<b>A</b>	LED 6 V red	<b>N</b>	LED 12 V blue
<b>B</b>	LED 6 V green	<b>S</b>	LED 12 V white
<b>C</b>	LED 6 V yellow	<b>J</b>	LED 24 V red
<b>M</b>	LED 6 V blue	<b>K</b>	LED 24 V green
<b>R</b>	LED 6 V white	<b>L</b>	LED 24 V yellow
<b>D</b>	LED 12 V red	<b>P</b>	LED 24 V blue
<b>E</b>	LED 12 V green	<b>T</b>	LED 24 V white

See following pages.

etc.

#### TERMINALS

##### Screw

**0** 6 terminals with barrier

##### Solder lug/quick-connect

- 2** 6 terminals with barrier
- 4** 6 terminals w/o barrier
- A** 10 term. with barrier
- B** 10 term. w/o barrier
- C** 10 terminals for use with connector U2292

##### Normalized quick-connect 6.35x0.8

- 3** 6 terminals with barrier
- 5** 6 terminals w/o barrier
- D** 10 term. with barrier
- E** 10 term. w/o barrier
- F** 10 term. for use with connector U2292 or U3152

##### Normalized quick-connect 2.8x0.8

- G** 10 term. with barrier
- H** 10 term. w/o barrier
- J** 10 terminals for use with connector U2282

\*\*\* S contacts for all functions except 5 and 4-1R - for normalized quick-connect terminals 6.35x0.8 only.

### ACTUATOR

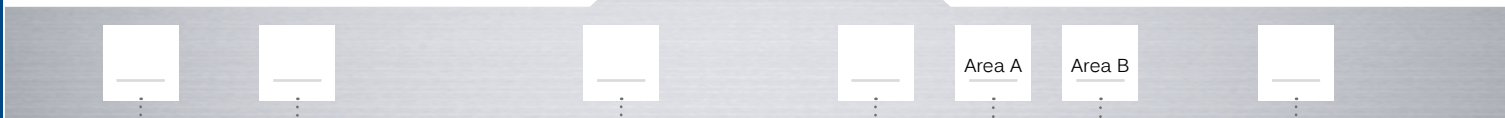

#### TYPE

- 1** For non-illuminated application
- 2** For illuminated application

#### UNLOCKING ACTUATOR COLOR

##### Hard plastic (ABS)

- 1** Blue
- 1/4** Dark blue
- 2** Black
- 3** Green
- 4** Grey
- 5** Yellow
- 6** Red
- 7** Ivory
- 9** Orange

##### Elastomer

- Y** Yellow
- R** Red
- G** Green

#### SYMBOLS

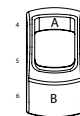

#### MARKING COLOR

##### Illuminated models

**Blank** White

##### Non-illuminated

- 1** Blue
- 2** Black
- 3** Green
- 4** Grey
- 5** Yellow
- 6** Red
- 7** White
- 9** Orange

#### ROCKER COLOR

- 1** Blue
- 1/4** Dark blue
- 2** Black
- 3** Green
- 4** Grey
- 5** Yellow
- 6** Red
- 7** Ivory
- 9** Orange

#### MARKING ORIENTATION



Symbols & Accessories : see end of the series.

NOTICE : please note that not all combinations of above numbers are available. Refer to following pages for further information.

# KL series

## Locking power rocker switches

### 6 TERMINAL VERSION



		2-3 5-6		1-2 4-5
Single pole	Double pole			
KL31	KL41	ON	-	OFF
	KL44*	ON	ON	ON
	KL44-1R*	ON	ON	MOM
KL35	KL45	MOM	-	ON
KL36	KL46	ON	-	ON
KL37	KL47	MOM	OFF	MOM
KL38	KL48	ON	OFF	MOM
KL39	KL49	ON	OFF	ON

\*Function 4 : single pole in double pole case

### 10 TERMINAL VERSION



		2-3 5-6		1-2 4-5
Single pole	Double pole			
KL31	KL41	ON	-	OFF
	KL44*	ON	ON	ON
	KL44-1R*	ON	ON	MOM
KL35	KL45	MOM	-	ON
KL36	KL46	ON	-	ON
KL37	KL47	MOM	OFF	MOM
KL38	KL48	ON	OFF	MOM
KL39	KL49	ON	OFF	ON

\*Function 4 : single pole in double pole case

→ FLAT SEAL  
47.00  
(1.850)

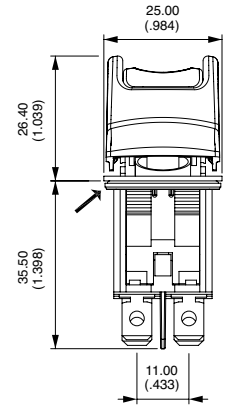
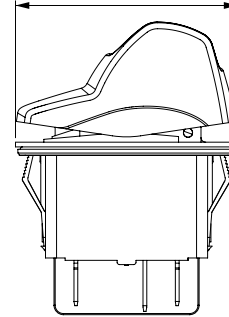

→ FLAT SEAL  
47.00  
(1.850)

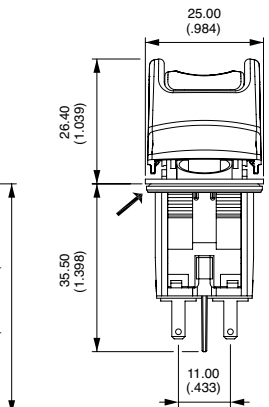
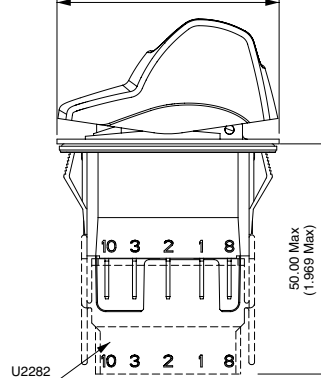

### CASE + LEDS

### TERMINALS

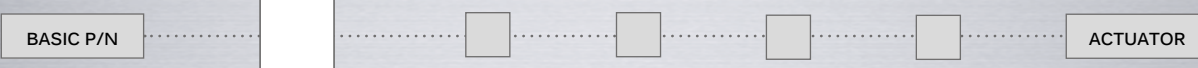

### SCREW

0 6 terminals with barrier

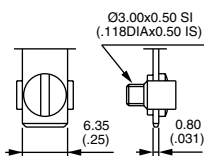

screw

### SOLDER LUG / QUICK-CONNECT

- 2 6 terminals with barrier
- 4 6 terminals w/o barrier
- A 10 terminals with barrier
- B 10 terminals w/o barrier
- C 10 terminals for use with connector U2292 or U3152

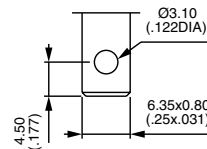

Solder lug / quick-connect

# KL series

Locking power rocker switches

## CASE + LEDS

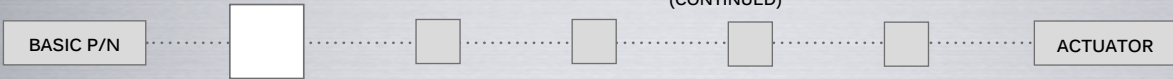

## TERMINALS (CONTINUED)

### NORMALIZED QUICK-CONNECT 6.35X0.8

- 3 6 terminals with barrier
- 5 6 terminals w/o barrier
- D 10 terminals with barrier
- E 10 terminals w/o barrier
- F 10 terminals for use with connector U2292 or U3152

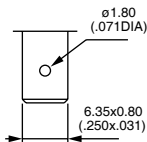

Normalized quick-connect 6.35x0.8

### NORMALIZED QUICK-CONNECT 2.8X0.8

- G 10 terminals with barrier
- H 10 terminals w/o barrier
- J 10 terminals for use with connector U2282

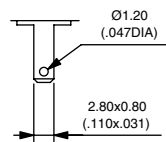

Normalized quick-connect 2.8x0.8

### 6 TERMINAL VERSION

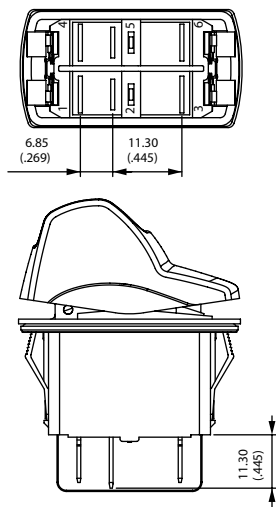

### 10 TERMINAL VERSION

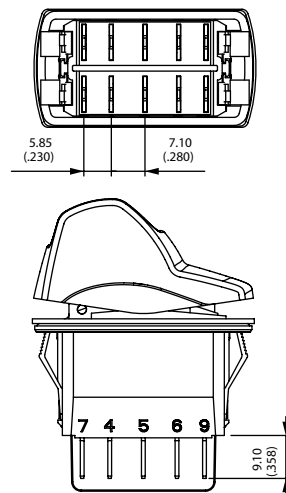

Terminals are marked on the case. The drawings show the maximum possible number of terminals.

## CASE + LEDS



## CONTACT MATERIALS

- A Silver
- D Silver, gold plated
- S Silver 20A. For all functions except 4 and 4-1R - for normalized quick-connect terminals 6.35x0.8 only.

# KL series

Locking power rocker switches

## CASE + LEDS

## SEALING



- X No sealing
- K IP68 (front panel components of switch only)
- Z IP69K - Installation notice available on request

Ultrasonic welding of frame to case is standard on all versions. The ultrasonic welding and the optional panel seal prevent water and dust from introducing into the switch housing.



## CASE + LEDS

## LEDS

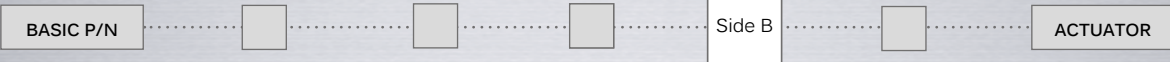

Complete enlarged box with one of the codes listed below.

- X Without LED

	Red	Green	Yellow	Blue	White	Amber	Red/green
6 VDC	A	B	C	M	R	4	1
12 VDC	D	E	F	N	S	5	2
24 VDC	J	K	L	P	T	6	3
No resistor	U	V	W	Y	Z	9	8

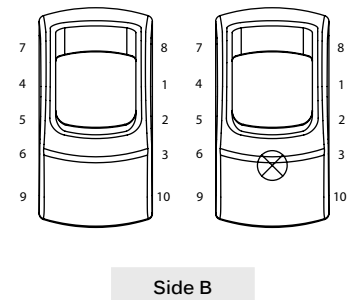

LED consumption : 20 mA @ nominal voltage (25 °C / 77 °F)  
Other illumination solutions : on request.

For non-stabilized on-board power supplies submitted to potential voltage surges due to the alternator, 15 V and 30 V LED configurations are also available on request. LED Tolerance ±10 %

## CASE + LEDS

## WIRING

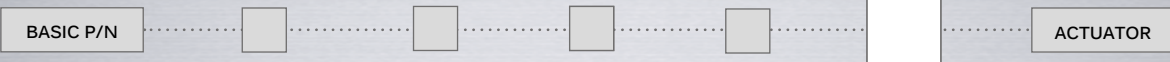

The LED wiring diagram is shown on the case.

FOR 6 TERMINAL VERSIONS - LED CONNECTED TO THE LOAD

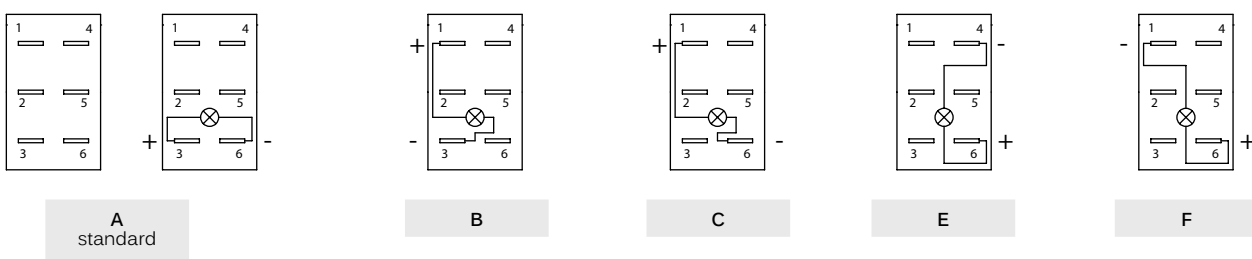

Note : If not available, terminals are added to connect the LED.

# KL series

Locking power rocker switches

## CASE + LEDS

## WIRING (CONTINUED)

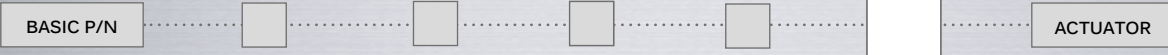

FOR 10 TERMINAL VERSIONS - INDEPENDENT LED OR INTEGRATED FUNCTIONS

- G** Standard, to have independent LED.
- H** To obtain 2 symbol illumination levels (night illumination when OFF and higher illumination when ON).  
*Dotted line = external wiring, continuous line = internal wiring*  
Available in Single Pole only, with H and J quick-connect terminals
- I** To have a polarity inversion (typical application : fan motor).  
*Dotted line = external wiring*  
Power supply between 2 and 5 - Load between 1 and 4 or 3 and 6.  
Available with H and J quick-connect terminals.

Please contact us for other wiring solutions.

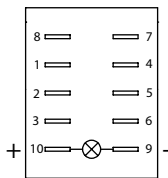

G

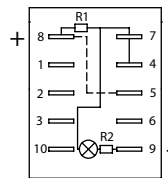

H

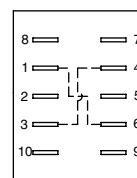

I

## ACTUATOR

## ACTUATOR TYPE



- 1 For non-illuminated application
- 2 For illuminated application

## ACTUATOR

## ROCKER COLOR



- 1 Blue
- 1/4 Dark blue
- 2 Black
- 3 Green
- 4 Grey
- 5 Yellow
- 6 Red
- 7 Ivory
- 9 Orange

Note : color 7 not available on illuminated versions



# KL series

Locking power rocker switches

## ACTUATOR

### UNLOCKING ACTUATOR



HARD PLASTIC (ABS)

- |     |           |   |        |
|-----|-----------|---|--------|
| 1   | Blue      | 5 | Yellow |
| 1/4 | Dark blue | 6 | Red    |
| 2   | Black     | 7 | Ivory  |
| 3   | Green     | 9 | Orange |
| 4   | Grey      |   |        |

ELASTOMER

- |   |        |
|---|--------|
| Y | Yellow |
| R | Red    |
| G | Green  |

## ACTUATOR

### MARKING ORIENTATION



If no marking required, complete the box with code N.  
Other orientations : on request

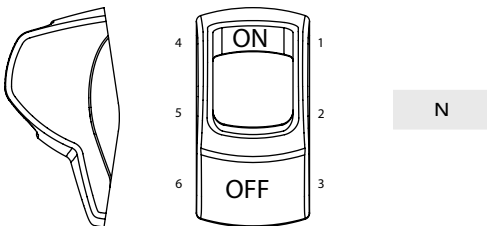

## ACTUATOR

### SYMBOLS

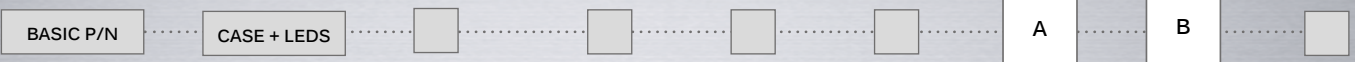

XX No symbol

#### Available symbols

Complete each enlarged box with the one of the codes listed on the following pages.

#### Laser etching resistance

- Water and petrol resistant according to EN61058-1
- Tear resistant (cross-cut test) according to NF ISO 2409 : class 0
- UV resistant according to ISO 4892-2

#### Marking area

The symbol will be included in the hatched area.

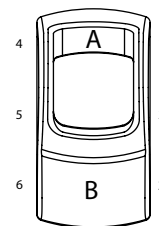

For illuminated versions

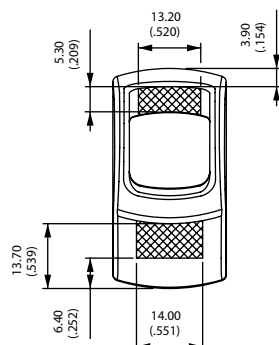

For non-illuminated versions

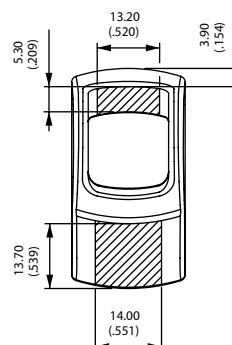

# KL series

Locking power rocker switches

ACTUATOR

MARKING COLOR



ILLUMINATED MODELS - LASER ETCHING

Blank White

NON-ILLUMINATED MODELS - PAD PRINTING

- 1 Blue
- 2 Black
- 3 Green
- 4 Grey
- 5 Yellow
- 6 Red
- 7 White
- 9 Orange

# K range

Power rocker switches and indicators • symbols and accessories

Most symbols meet the ISO 7000 standard “graphical symbols for use on equipment” (code given in bracket in the description).  
Contact us for symbols not featured in the following tables.



CODE	SYMBOL	DESCRIPTION
XX	None	-
01	<b>ON</b>	-
02	<b>OFF</b>	-
03	○	-
04	I	-
05	II	-
06	<b>STOP</b>	-
07	<b>A</b>	Stop
08	<b>M</b>	Motion
09	▲	Up motion
10	▼	Down motion
11	☀	Hot
12	✖	Cold
13	⚠	Hazard warning (0085)
14	☀	Traveller lighting
15	☀	Driver lighting (1421)

CODE	SYMBOL	DESCRIPTION
16	☀	Revolving light
17	☐	Rear ventilator
18	☀	Heating (0637)
19	☐	Door opening
20	☀	Windshield demister/defroster (0635)
21	☀	Windshield wiper (0086)
22	☀	Windshield washer (0088)
23	☀	Ventilator fan (0089)
24	☀	Side mirror defroster
25	⚙	Restarting pump
26	☀	Front fog lights (0633)
27	☀	Rear fog lights (0634)
28	☀	Propulsion system trim
29	☀	Beacon (1141)
30	⚓	Anchor
31	🔌	Electric motor (0011)

CODE	SYMBOL	DESCRIPTION
32	🚑	Emergency first aid vehicle (2565)
33	🚛	Load tipping (1557)
34	🚛	Loading light (2457)
35	🚜	Tractor, rear-ward (1667)
36	🚛	Combine, direction of movement (1678)
37	🚛	Use no forks (2406)
38	⚙	Transmission (1166)
39	☀	Working spot light (1145)
40	🚗	Engine (0640)
41	📢	Horn (0244)
42	🔒	Lock (1656)
43	🚕	Taxi sign light (2551)
44	☀	Working light (1204)
45	☀	Working light symmetric (1204)
46	🔌	-
47	<b>ASM</b>	-

The company reserves the right to change specifications without notice.

# K range

Power rocker switches and indicators • symbols and accessories

CODE	SYMBOL	DESCRIPTION	CODE	SYMBOL	DESCRIPTION	CODE	SYMBOL	DESCRIPTION
48		All wheel drive	69		Engine idle control	90		ECAS reset
49		Differential lock (1662)	70		Cruise res/set	91		Driver windows heating
50		-	71		Driver windows up/down	92		Cruise set
51		-	72		Middle door opening	93		Air bag up/down
52		-	73		Front door opening	94		Read lighting
53		-	74		Lighting in baggage room	95		Lighting main switch
54		Rear window wiper (0097)	75		Cruise on/off	96		Heating using water
55		Rear window washer (0099)	76		TV	97		Low beam
56		Lower load (2223)	77		Pump	98		Position lights
57		Cab lock (1560)	78		Toilet	99		Diesel acceleration
58		Extraction	79		Toilet decontamination	A1		Manual mode
59		Pumping in	80		Front windshield heating	A2		Clockwise cabin rotation
60		Rear PTO (1572)	81		Aus	A3		Anticlockwise cabin rotation
61		Front PTO	82		Radiator fan	A4		-
62		Rockshaft down	83		Remove retarder	A5		-
63		Rockshaft up	84		Restricted speed	A6		Parking brake
64		Indicator	85		Preheater	A7		-
65		Brake release	86		ABS detection	A8		-
66		Baggage room left door	87		ECAS detection	A9		-
67		Baggage room right door	88		Engine stop	AA		-
68		Power blinds	89		Cruise res/cancel	AB		-

# K range

Power rocker switches and indicators • symbols and accessories

CODE	SYMBOL	DESCRIPTION
AC		-
AD		-
AE		-
AF		-
AG		Battery charging condition (0247)
AH		Turn signals (0084)
AJ		High beam (0082)
AK		Differential lock, bogie (2600)
AL		Brushing with a rotating brush (0070)
AM		Differential lock, transfer case 4x4 (2475)
AN		Loader bucket, float (1441)
AP		Loader bucket (1437)
AQ		Rear window washer & wiper (0098)
AR		Header, Header drive (1579)
AS		Excavator/backhoe boom side shift (2091)
AT		Chemical water treatment (1851)
AU		Grapple skidder, single funct° boom (1762)

CODE	SYMBOL	DESCRIPTION
AV		-
AW		-
AY		-
AZ		-
B1	HIGH	-
B2	LOW	-
B3		-

### Legend scale

Depending on space available on the product (see "Symbols" section at the end of each series).

# K range

Power rocker switches and indicators • symbols and accessories

## MOUNTING PANELS

(NOT AVAILABLE FOR USE WITH THE KH SERIES)

MOUNTING PANEL END

MOUNTING PANEL MIDDLE

SINGLE MOUNTING PANEL

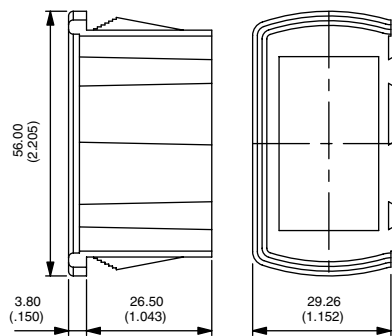

U2261

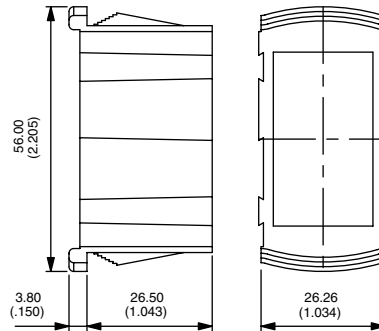

U2262

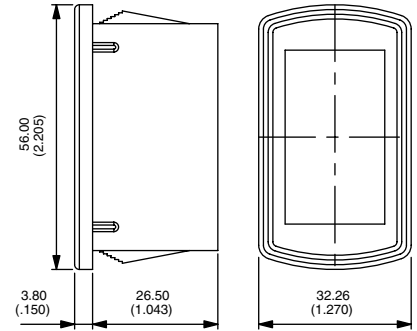

U2267

Recommended panel thickness : 1.10 mm - 1.80 mm - 2.60 mm - 3.40 mm - 4.20 mm - 5 mm - 5.80 mm

## MOUNTING PANEL CUT-OUT

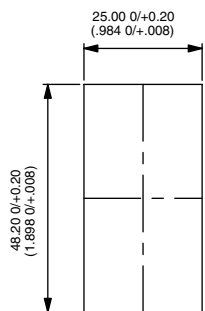

For 1 element U2267

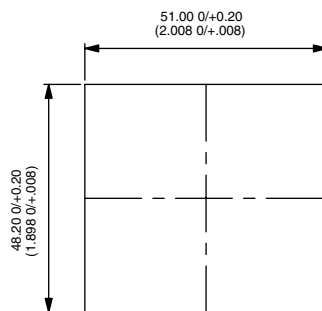

For 2 elements U2261

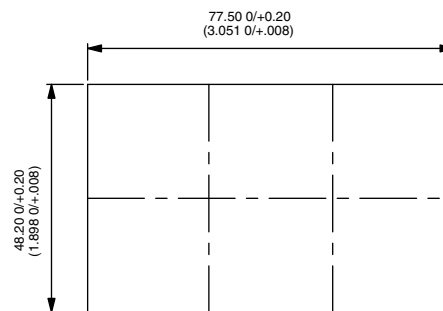

For 3 elements (2xU2261 + 1x U2262)

For additional elements, add 26.40 mm (1.039)

# K range

Power rocker switches and indicators • symbols and accessories

## 22 X 44 ADAPTERS

FRONT PANEL DISMOUNTING

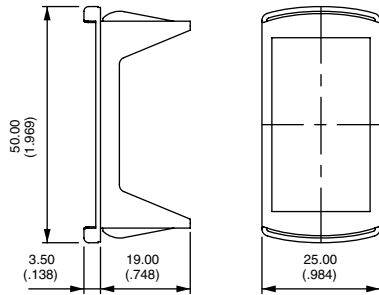

U3060

REAR PANEL DISMOUNTING

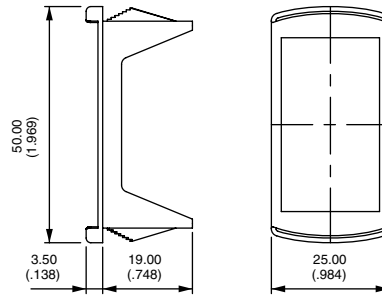

U3070

PANEL CUT-OUT

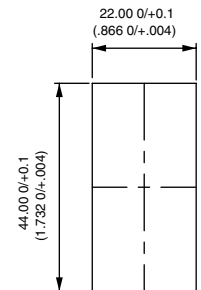

**Recommended panel thickness**

**U3060** 0.60 mm to 1.50 mm

**U3070** 1.60 mm -0.1/0 to 5.60 mm -0.1/0 in stages of 0.40 mm

**Adapter colors (replace 0 with code)**

- 1/4 Dark blue
- 2 Black
- 4 Grey
- 5 Yellow
- 6 Red
- 7/1 White

## ACTUATOR REMOVING TOOL

(NOT SUITABLE FOR USE WITH KH1 MODELS - 4-SIDE PROTECTION GUARDS)

### Extract actuator (KR only)

Allows the extraction of the rocker / rocker support assembly. Place the 2 claws under the support and push as indicated by the arrow.

### Extract rocker (KR only)

Allows to separate the rocker from its support. Insert the tool between rocker and support as indicated by the arrow. Pull out the tool in the opposite direction.

### Extract switch (KR, KL and KI)

Allows to extract switch from panel mounting units. 2 Tools are necessary. Insert the tools between switch and panel mounting units from the rear to compress the snap-in device. Pull off switch manually.



U3052

to be ordered by pairs

## BLANKING CAPS

Usefull for future extensions.

Connectors can be hanged on specific hole plugs. Contact APEM.

- |         |           |       |        |
|---------|-----------|-------|--------|
| U2271   | Blue      | U2275 | Yellow |
| U2271/4 | Dark blue | U2276 | Red    |
| U2272   | Black     | U2277 | Ivory  |
| U2273   | Green     | U2279 | Orange |
| U2274   | Grey      |       |        |

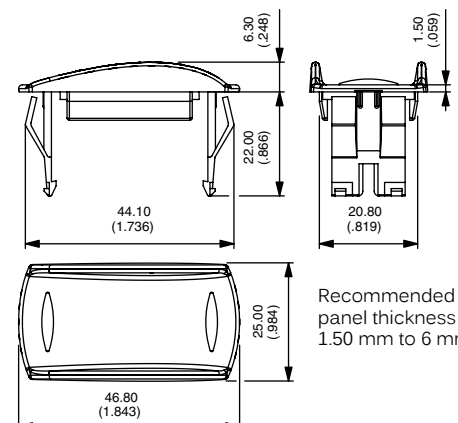

# K range

Power rocker switches and indicators • symbols and accessories

## CONNECTORS

Standard color : black. Other colors : on request. Connectors cannot be combined with wiring types H and I.

**U2260** 6 terminal version. For use with terminals type 2, 3, 4 or 5.  
6.35 (1/4) tabs to be fitted by the user (example : TE42282-2).  
Can be used for the KG series.

**U2282** 10 terminal version. For use with terminals type H or J.  
2.8 (.110) tabs to be fitted by the user (example : AMP/Tyco 0-927779-3).

**U2292** 10 terminal version : For use with terminals type B, C, E or F.  
6.35 (1/4) tabs to be fitted by the user (example : TE42282-2).

**U3152** 10 terminal version. For use with terminals type B, C, E or F.  
6.35 (1/4) tabs to be fitted by the user (example : "Timer" terminals TE927833-2)

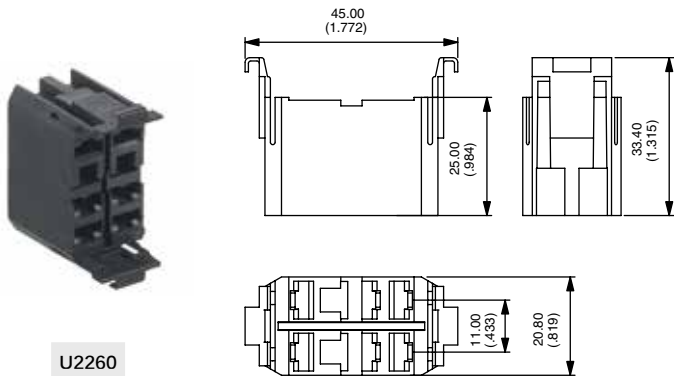

U2260

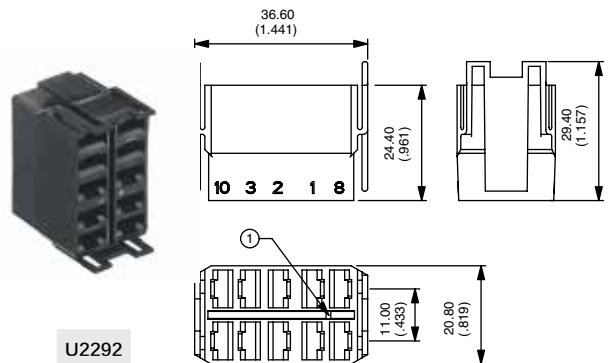

U2292

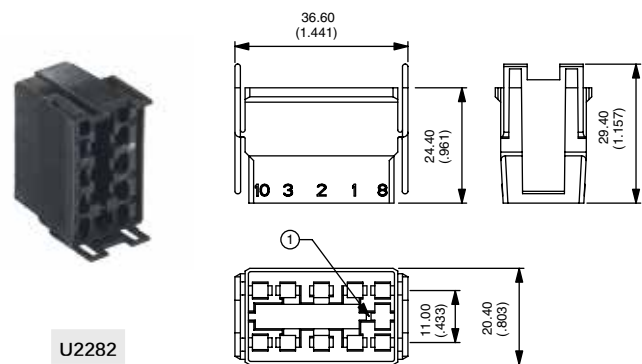

U2282

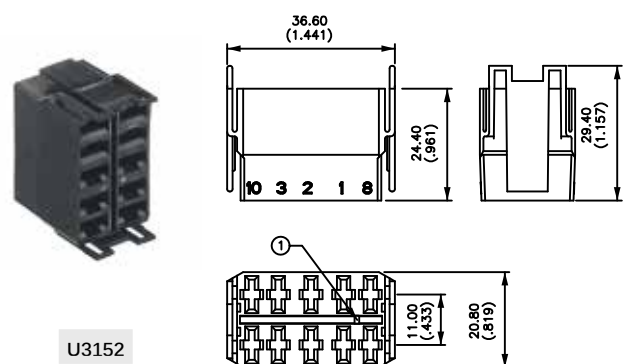

U3152