

Type 23 Series

Key Features

- Versatile design can be customised to suit your requirements
- 0.4 Watt at 40°C
- Die Cast Metal Bush Available
- Insulated Bush Available
- Insulated Shafts up to 50mm
- Eyelet or PC Terminations
- Rugged Construction
- Mounting Bracket
- Audio Laws Available
- Dual Gang and Dual Concentric Styles



A popular range of 20mm control potentiometers, the type 23 series can be tailored to suit more specific requirements. The potentiometers are available with printed carbon resistance element, choice of bush lengths in metal or plastic and insulated shafts up to 50mm in length. In addition, approved mains and low current switches are available as standard options.

Characteristics - Electrical

Resistance Range (Law):	1K to 1M (Linear) 4K7 to 470K (Non Linear)
Resistance Values:	1, 2.2 and 4.7 per decade
Resistance Tolerance:	± 20% (± 10% by selection)
Rated Dissipation at 40°C:	0.4W (Linear), 0.2W (Non Linear)
Limiting Element Voltage:	500V DC or AC RMS
Electrical Rotation:	267° without switch, 232° with switch
Terminal Resistance:	5 Ohms maximum
Noise (ENR):	2% maximum (Linear), 3% maximum (Non Linear)
Insulation Resistance:	4G minimum
Voltage Proof:	1000 V AC peak

Characteristics - Mechanical

Operating Torque:	15 mNm maximum
Mechanical Rotation:	300°
End Stop Torque:	800 mNm maximum

Characteristics - Environmental

Limits of Resistance Change:	15% (After 1000 hours endurance)
Operating Temperature Range:	-25°C to +70°C
Temperature Characteristics of Resistance:	5% (-55°C to 125°C)
Bump Severity:	390m/s ² , 4000 Bumps
Vibration Severity:	10 - 500 Hz, 0.75mm or 98m/s ²
Climatic Category:	8 days @ 36°C 82% RH R < 15%
Mechanical Endurance:	15000 Operations (minimum)

Type 23 Series

DIY Design

The 23 Series can be customised to suit your individual requirements with features such as detent action, track centre tap etc.

Please call our technical sales team to discuss variations on these 20mm diameter devices.

Dimensions Type 23



Type 24



Type 25



Type 26 (Non Switched only)



Type 27



Type 28

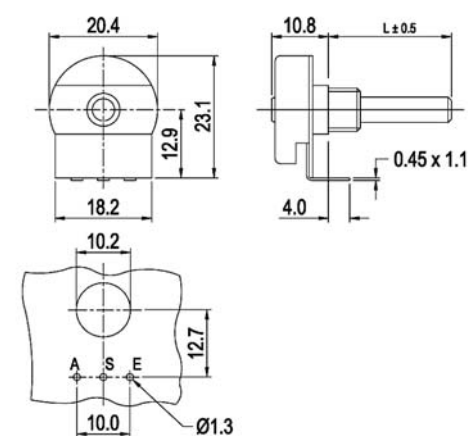

Type 23 Series

Type 29

Switched Types



How to Order

23	E	X	A	104	M	L	B	22	A		
Potentiometer Type	Customer Identity		Resistance Value			Bush Details		Shaft Length			
23 - Std Spindle Style 24 - Standard 20mm with Mounting Bracket 25 - No Bush - Mounting Bracket Terminations swept forward parallel to shaft 26 - PC Terminations swept down to board for rear mounting 27 - Dual gang style single shaft same value / tol on each section 28 - PC Terminations swept forward parallel to shaft 29 - Dual Concentric style	S - Standard X - Customer Special See Drawing (provide copy with order) D - Special Cut and Mtd track		The first two digits are significant figures of resistance value and the third denotes the number of zeros following. e.g. 100R Ohms: 101 4.7K Ohms: 472 22K Ohms: 223 100K Ohms: 104			L - Diecast M10 x 9mm no locator lug, 6mm hole W - Diecast M10 x 9mm with locator, 6mm hole Y - Diecast M10 x 9mm no locator, 4mm hole M - Diecast 3/8" x 8mm with locator lug, 6.35mm hole K - Diecast 3/8" x 8mm no locator, 6.35mm hole P - Diecast M7 x 6mm no locator, 4mm hole S - Insulated M10 x 7mm 6mm hole T - Insulated M10 x 10mm 6mm hole U - No Bush F - Diecast 3/8" x 12mm 6.35mm hole G - Diecast 3/8" x 8mm no locator, 4mm hole		FMF in mm i.e. 22mm			
Termination Style		Resistance Law			Resistance Tolerance		Shaft Style		Switch Details		
E - Std Eyelet P - Std PC 15mm MH R - Long PC X - Extra long PC S - PC bend forward at 90°		A - Linear B - Log C - Inv. Log			M - 20% K - 10%		A - Plain 6mm B - Slotted 6mm C - Flatted 6mm (5mm A/F) D - Flatted 6mm deep flat 4mm A/F E - Plain 4mm F - Full 6.35mm flat - special angle G - Flatted 4mm H - Plain 6.35mm J - Flatted 5.5mm L - Flatted 6mm (4.6mm A/F)		A - DPST 4A/250V AC B - SPST - Eyelet Termination C - DPDT - Changeover Switch N - No Switch T - SPST - PC Terminals		

TE Connectivity, TE connectivity (logo) and TE (logo) are trademarks.
 Other logos, product and Company names mentioned herein may be trademarks of their respective owners.

While TE has made every reasonable effort to ensure the accuracy of the information in this datasheet, TE does not guarantee that it is error-free, nor does TE make any other representation, warranty or guarantee that the information is accurate, correct, reliable or current. TE reserves the right to make any adjustments to the information contained herein at any time without notice. TE expressly disclaims all implied warranties regarding the information contained herein, including, but not limited to, any implied warranties of merchantability or fitness for a particular purpose. The dimensions in this datasheet are for reference purposes only and are subject to change without notice. Specifications are subject to change without notice. Consult TE for the latest dimensions and design specifications.

Mouser Electronics

Authorized Distributor

Click to View Pricing, Inventory, Delivery & Lifecycle Information:

[TE Connectivity:](#)

[23ESA102MMF50N](#)