



DEUTSCH

BRANCHE CONNECTEURS AEROMILITAIRES

PDF.Support



AFD series Norme MIL-C 26482 G

Series 2

| | |
|--------------------------------|----|
| Introduction | 1 |
| Advantage | 2 |
| Technical characteristics | 3 |
| Part-numbering system | 4 |
| Standard equivalence | 5 |
| Synoptic | 6 |
| Arrangements | 8 |
| Receptacles | 10 |
| Plugs | 14 |
| Large receptacles | 18 |
| Mating and unmating dimensions | 21 |
| Accessories | 22 |
| Protective covers | 24 |
| Contacts and tools | 26 |
| Contacts and tools for coax | 28 |
| Bushings | 30 |
| Part-numbering system hermetic | 31 |
| Hermetic receptacles | 33 |



- 1** – Triple wire seal.
- 2** – Mechanical retention of insert into shell by means of snap ring.
- 3** – Interfacial seal ensured by compression of insert and static / dynamic seal.
- 4** – Contacts individual sealing at coupling stage by compression of elastomer conical risers on hard insert.
- 5** – Anti-friction washers for constant mating force.
- 6** – Insert to shell sealing with potting.
- 7** – Connector's rear part fitted with a teeth anti-rotation system assuming an effective tightening and clamping.

Representing the most advanced design in use which both reflects and sets the pace for future developments, Compagnie DEUTSCH presents its AFD series connectors meet requirements of MIL-C 26482 G series 2 bayonet coupling connectors.

The Compagnie DEUTSCH AFD series connectors offer several advantages over previous devices such as :

- Higher performance characteristics.
- Completely sealed against rigorous environments.
- Reduced assembly and rework costs.
- Simplified assembly procedures.
- Hard plastic socket interface prevents penetration of bent pins.
- Rear release system from the rear of the connector.
- RFI fingers available for AFD 57 only.
- Intermateability and interchangeability with Compagnie DEUTSCH series connectors :
 - 951 meet requirements of NFL 54125 B and UTE 93422 model HE 301 B.
 - FDDB meet requirements of MIL-C 26482 and UTE 93422 model HE 302 and 303.
- Available in 9 shell sizes and 27 various insert arrangements.
- Hermetically sealed electrical connectors in DBC version.

Mechanical

| | | |
|-----------------------|------------------------|--|
| Shell and accessoires | Material Plating | : Aluminum alloy : Nickel, standard, corrosion test as per MIL - STD 1344 Modifications index olive drab cadmium |
| Silicone insert | Material Resistance | : Front and rear silicone inserts are devoid of all organic matter : Withstands fluids to MIL-C 26482 G standard |
| Contact | Type Finish | : Crimp type : Gold over nickel |
| Durability | | : 500 full coupling and uncoupling cycles 250 RFI fingers cycles |
| Contact Retention | | Contacts withstand a minimum load of : Size 20 : 6,93 daN Size 16 : 11,56 daN Size 12 : 11,56 daN Size 8 : 11,56 daN |
| Temperature | | : - 55° C to + 200° C |
| Air Leakage | | : Leakage inferior to 16 cm ³ /hour under a 2,1 bars differential pressure |
| Thermal Shocks | | : 5 cycles of - 55° C to + 200° C |
| Vibrations | | : No mechanical nor electrical failure further to 12 hours vibration (4 hours in the 3 axes), 20 G from 10 to 2000 Hz |
| Physical Shocks | | : 100 G 11 ms in the 3 axes |

Electrical

| | | |
|---------------------------------|---|--|
| Withstanding voltage | at sea level | : Service 1 : 1500 V 50 Hz (R.M.S) Service 2 : 2300 V 50 Hz (R.M.S) |
| | at 15000 m altitude | : Service 1 : 500 V Service 2 : 750 V |
| | at 21000 m altitude | : Service 1 : 375 V Service 2 : 500 V |
| | at 33000 m altitude | : Service 1 : 200 V Service 2 : 200 V |
| | Insulation resistance | : Higher than 5000 MΩ at 25° C at 60% R.H. |
| Contacts maximum current | : Size 20 : 7,5 A. Size 16 : 13 A. Size 12 : 23 A. Size 8 : 46 A. | |
| Contact millivolt drop | : Size 20 : 15 mv at 7,5 A. Size 16 : 21 mv at 13 A. Size 12 : 22 mv at 23 A. Size 8 : 25 mv at 23 A. | |
| Allowed wires section | : Size 20 : 0,21 to 0,60 mm ² Size 16 : 0,60 to 1,34 mm ² Size 12 : 1,91 to 3,18 mm ² Size 8 : 5,30 to 8,98 mm ² | |
| Diameter over insulating sheath | : Size 20 : 1,01 to 2,10 mm Size 16 : 1,73 to 2,62 mm Size 12 : 2,69 to 4,01 mm Size 8 : 3,80 to 5,15 mm | |

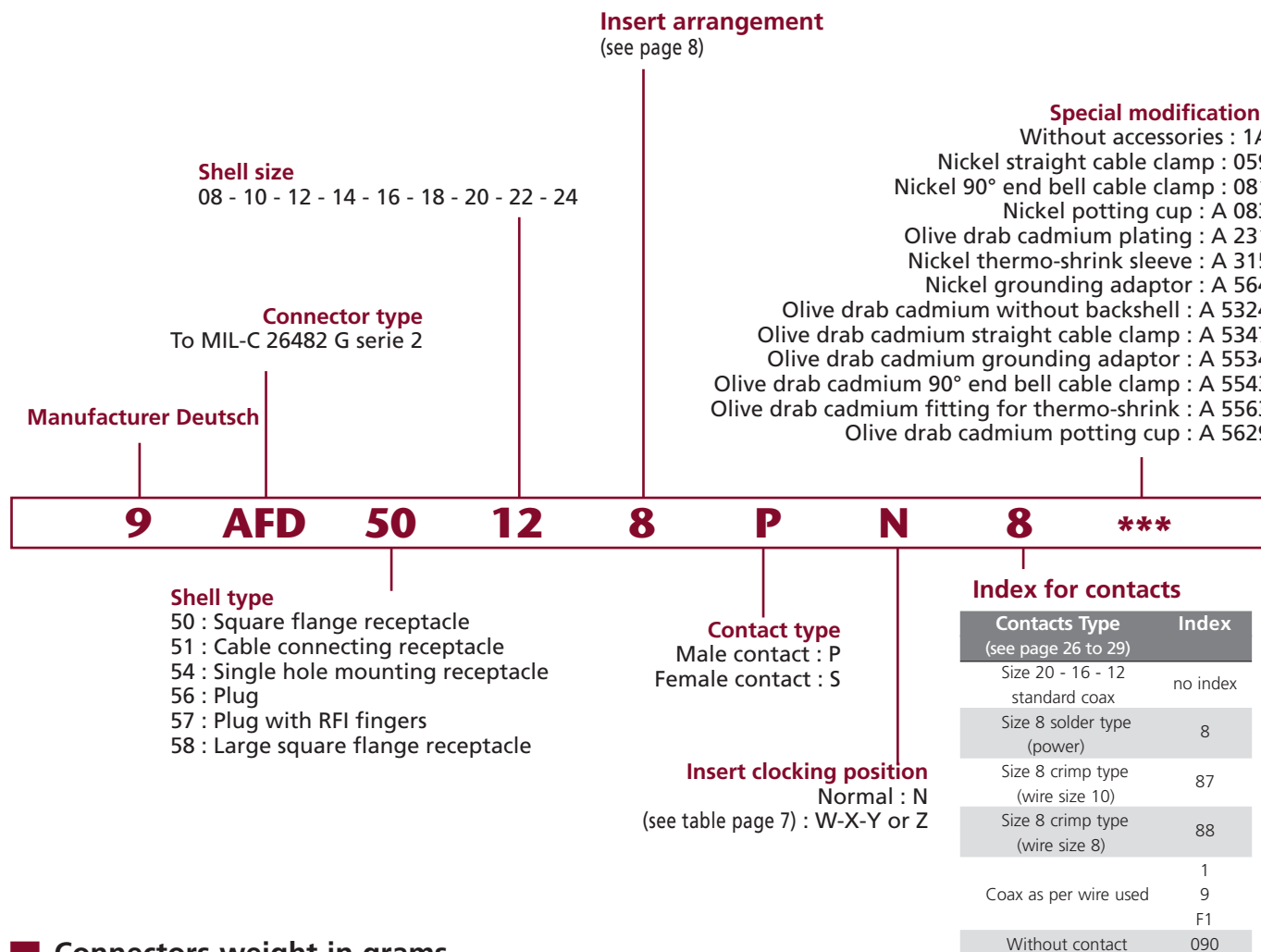

Connectors weight in grams

| Size | AFD 50 Shell and contacts without backshell | | AFD 54 Shell and contacts without backshell | | AFD 56/57 Shell and contacts without backshell | | Accessories weight | | |
|-------|---|--------|---|--------|--|--------|--------------------|-------------------------|-----------------------------|
| | Male | Female | Male | Female | Male | Female | Backshell | Straight cable clamp | 90° end bell cable clamp |
| 8-3A | 7,60* | 8,00 | 10,80* | 11,20 | 10,00 | 10,40 | 2,44 | 6,50 | 8,35 |
| 10-06 | 11,50 | 12,30 | 14,50 | 15,20 | 14,70 | 15,50 | 5,49 | 7,90 | 10,10 |
| 12-10 | 14,50 | 15,20* | 20,90 | 21,60 | 20,10 | 20,80 | 6,48 | 7,70 | 11,70 |
| 14-19 | 18,00 | 19,50* | 25,80* | 27,30 | 22,50 | 24,00 | 7,48 | 9,90 | 15,20 |
| 16-26 | 23,10 | 25,70* | 31,50 | 34,10* | 28,70 | 31,30 | 8,99 | 12,00 | 16,50 |
| 18-32 | 26,10* | 29,00 | 37,60* | 40,50 | 34,00 | 36,90 | 10,97 | 13,70 | 20,35 |
| 20-41 | 32,20* | 36,20 | 49,10 | 53,10* | 39,70 | 43,70 | 11,97 | 15,00 | 24,90 |
| 22-55 | 39,80* | 44,00 | 56,80* | 61,00 | 46,00 | 50,20 | 13,97 | 17,10 | 26,20 |
| 24-61 | 49,50* | 56,00 | 65,50* | 72,00 | 53,10 | 61,20 | 15,16 | 18,50 | 34,70 |

* Calculated value

Contacts weight in grams

| Taille | Type | Reference | Weight in grams |
|--------|------|---------------|--------------------|
| 20 | P | 006-0937-20-A | 0,25 |
| | S | 006-0912-20 | 0,28 |
| 16 | P | 006-0937-16-A | 0,56 |
| | S | 006-0912-16 | 0,61 |
| 12 | P | 006-0937-12-A | 1,23 |
| | S | 006-0912-12 | 1,22 |
| 08 | P | 005-0893-08 | 3,18 |
| | S | 005-0896-08 | 2,90 |
| Coax. | P | 005-0920-00 | 6,68 |
| | S | 005-0921-00 | 6,88 |

Connectors

| Reference MIL-C 83723 | Reference MS 3470 | Reference Panavia 6432 | Reference Deutsch | Finish |
|--------------------------|----------------------|---------------------------|----------------------|-----------------------------|
| - | - | PAN 6432-1B-**-P/N | AFD 50-**-P/N A 5324 | Olive drab cadmium |
| - | MS 3470-W-**-P/N | - | AFD 50-**-P/N A 5727 | Olive drab cadmium |
| M 83723-02-R-**-N | MS 3470-L-**-P/N | - | AFD 50-**-P/N A 5730 | Nickel plating |
| M 83723-02-A-**-N | - | - | AFD 50-**-P/N 6116 | Black anodized |
| - | - | PAN 6432-1B-**-P/N | AFD 50-**-S/N A 5324 | Olive drab cadmium |
| - | MS 3470-W-**-S/N | - | AFD 50-**-S/N A 5727 | Olive drab cadmium |
| M 83723-01-R-**-N | MS 3470-L-**-S/N | - | AFD 50-**-S/N A 5730 | Nickel plating |
| M 83723-01-A-**-N | - | - | AFD 50-**-S/N 6116 | Black anodized |
| - | MS 3472-W-**-P/N | - | AFD 58-**-P/N A 5727 | Olive drab cadmium |
| M 83723-04-R-**-N | MS 3472-L-**-P/N | - | AFD 58-**-P/N A 5730 | Contacts with 3 color bands |
| M 83723-04-A-**-N | - | - | AFD 58-**-P/N 6116 | Black anodized |
| - | MS 3472-W-**-S/N | - | AFD 58-**-S/N A 5727 | Olive drab cadmium |
| M 83723-03-R-**-N | MS 3472-L-**-S/N | - | AFD 58-**-S/N A 5730 | Nickel plating |
| M 83723-03-A-**-N | - | - | AFD 58-**-S/N 6116 | Black anodized |
| - | - | PAN 6432-1A-**-P/N | AFD 54-**-P/N A 5324 | Olive drab cadmium |
| - | MS 3474-W-**-P/N | - | AFD 54-**-P/N A 5727 | Olive drab cadmium |
| M 83723-06-R-**-N | MS 3474-L-**-P/N | - | AFD 54-**-P/N A 5730 | Nickel plating |
| M 83723-06-A-**-N | - | - | AFD 54-**-P/N 6116 | Black anodized |
| - | - | PAN 6432-1A-**-S/N | AFD 54-**-S/N A 5324 | Olive drab cadmium |
| - | MS 3474-W-**-S/N | - | AFD 54-**-S/N A 5727 | Olive drab cadmium |
| M 83723-05-R-**-N | MS 3474-L-**-S/N | - | AFD 54-**-S/N A 5730 | Nickel plating |
| M 83723-05-A-**-N | - | - | AFD 54-**-S/N 6116 | Black anodized |
| - | MS 3471-W-**-P/N | - | AFD 51-**-P/N A 5727 | Olive drab cadmium |
| M 83723-08-R-**-N | MS 3471-L-**-P/N | - | AFD 51-**-P/N A 5730 | Nickel plating |
| M 83723-08-A-**-N | - | - | AFD 51-**-P/N 6116 | Black anodized |
| - | MS 3471-W-**-S/N | - | AFD 51-**-S/N A 5727 | Olive drab cadmium |
| M 83723-07-R-**-N | MS 3471-L-**-S/N | - | AFD 51-**-S/N A 5730 | Nickel plating |
| M 83723-07-A-**-N | - | - | AFD 51-**-S/N 6116 | Black anodized |
| - | - | PAN 6432-1F-**-P/N | AFD 56-**-P/N A 5324 | Olive drab cadmium |
| - | MS 3476-W-**-P/N | - | AFD 56-**-P/N A 5727 | Olive drab cadmium |
| M 83723-14-R-**-N | MS 3476-L-**-P/N | - | AFD 56-**-P/N A 5730 | Nickel plating |
| M 83723-14-A-**-N | - | - | AFD 56-**-P/N 6116 | Black anodized |
| - | - | PAN 6432-1F-**-S/N | AFD 56-**-S/N A 5324 | Olive drab cadmium |
| - | MS 3476-W-**-S/N | - | AFD 56-**-S/N A 5727 | Olive drab cadmium |
| MS 83723-13-R-**-N | MS 3476-L-**-S/N | - | AFD 56-**-S/N A 5730 | Nickel plating |
| MS 83723-13-A-**-N | - | - | AFD 56-**-S/N 6116 | Black anodized |
| - | MS 3475-W-**-P/N | - | AFD 57-**-P/N A 5727 | Olive drab cadmium |
| M 83723-42-R-**-N | MS 3475-L-**-P/N | - | AFD 57-**-P/N A 5730 | Nickel plating |
| M 83723-42-A-**-N | - | - | AFD 57-**-P/N 6116 | Black anodized |
| - | MS 3475-W-**-S/N | - | AFD 57-**-S/N A 5727 | Olive drab cadmium |
| M 83723-43-R-**-N | MS 3475-L-**-S/N | - | AFD 57-**-S/N A 5730 | Nickel plating |
| M 83723-43-A-**-N | - | - | AFD 57-**-S/N 6116 | Black anodized |

Rear accessories

| Ms Nickel Reference | Nickel plated | | Olive drab cadmium | |
|--|-----------------------------|--|------------------------------------|---|
| | Deutsch Nickel Reference | | MS olive drab cadmium Reference | Deutsch olive drab cadmium Reference |
| Backshell MS 3416-**-EN | 94002-**-3014 | | MS 3416-**-EC | 94002-**- A 231 |
| Straight cable clamp MS 3417-**-N | 94003-**-3014 | | MS 3417-**-C | 94003-**-A 231 |
| 90° end bell cable clamp MS 3418-**-N | 94004-**-3014 | | MS 3418-**-C | 94004-**- A 231 |

Contacts

| Size | Type | Reference norm | Deutsch reference to be ordered |
|------|------|-------------------|------------------------------------|
| 20 | P | M 39029/4-110 | 006-0937-20-A 834 |
| | S | M 39029/5-115 | 006-0912-20-A 834 |
| 16 | P | M 39029/4-111 | 006-0937-16-A 834 |
| | S | M 39029/5-116 | 006-0912-16-A 834 |
| 16 | P | M 39029/4-112 | 006-1168-16-A 834 |
| | S | M 39029/5-117 | 006-1169-16-A 834 |
| 12 | P | M 39029/4-113 | 006-0937-12-A 834 |
| | S | M 39029/5-118 | 006-0912-12-A 834 |
| 12 | P | M 39029/4-114 | 006-1157-12-A 834 |
| | S | M 39029/5-119 | 006-1159-12-A 834 |

Accessories

Receptacles

Plugs

Accessories

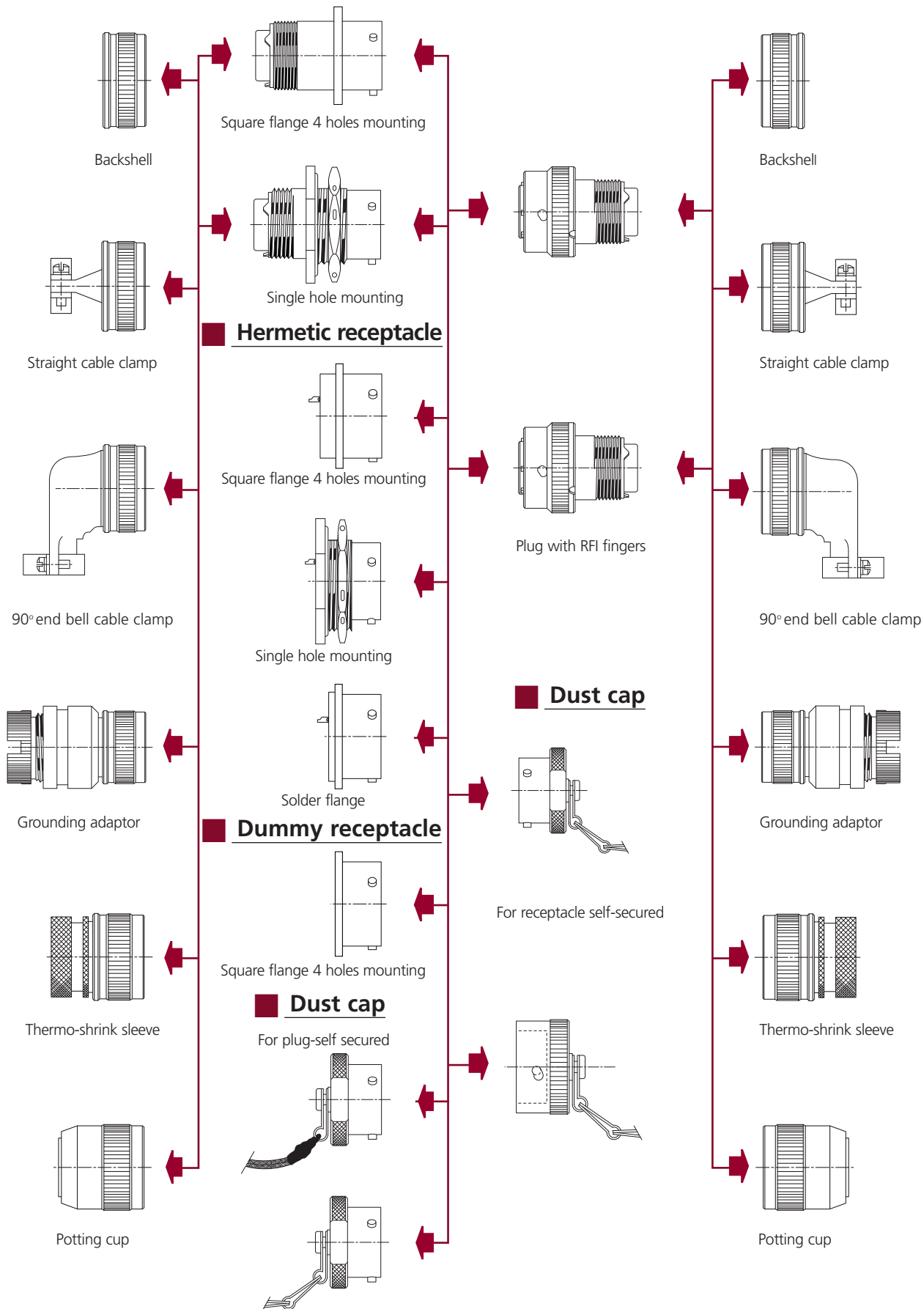

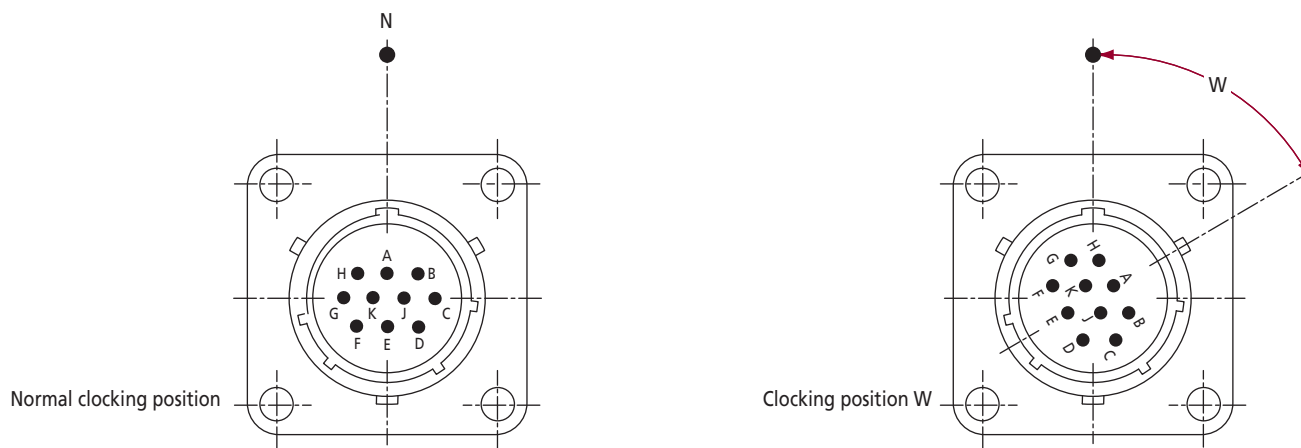

Example of insert angular displacement, pin front face view

Clocking position is normal when the insert vertical axis is intermingled with the shell keyway axis. An unkeying can be performed between 2 connectors of same layout by angular displacement of one of the inserts in its shell. This insert rotation is made in the clockwise for pin layouts and in the counter clockwise for socket layouts. Angular displacements on the hereafter table give clocking positions W, X, Y or Z.

| Insert Arrangt. | Clocking position in degrees | | | | Contacts sizes | | | | | | |
|-----------------|------------------------------|-----|-----|-----|----------------|----|----|-----------|----------|----------|------|
| | w | x | y | z | 20 | 16 | 12 | 8 or Coax | Standard | Hermetic | Serv |
| 08-3A | 60 | - | - | - | 3 | - | - | - | 1 | 1 | I |
| 08-33 | 90 | - | - | - | 3 | - | - | - | 1 | 1 | I |
| 8-98 | 60 | 210 | - | - | 3 | - | - | - | 1 | 1 | I |
| 10-6 | 90 | - | - | - | 6 | - | - | - | 1 | 1 | I |
| 12-3 | - | - | 180 | - | - | 3 | - | - | 1 | 1 | II |
| 12-8 | 90 | 112 | 203 | 292 | 8 | - | - | - | 1 | - | I |
| 12-10 | 60 | 155 | 270 | 295 | 10 | - | - | - | 1 | 1 | I |
| 14-4 | - | - | - | - | - | - | 4 | - | 1 | 1 | I |
| 14-5 | 40 | 92 | 184 | 273 | - | 5 | - | - | 1 | 1 | II |
| 14-12 | 43 | 90 | - | - | 8 | 4 | - | - | 1 | 1 | I |
| 14-15 | 17 | 110 | 155 | 234 | 14 | 1 | - | - | 1 | 1 | I |
| 14-18 | 15 | 90 | 180 | 270 | 18 | - | - | - | 1 | 1 | I |
| 14-19 | 30 | 165 | 315 | - | 19 | - | - | - | 1 | 1 | I |
| 16-8 | 54 | 152 | 180 | 331 | - | 8 | - | - | 1 | 1 | II |
| 16-26 | 60 | 105 | 275 | 338 | 26 | - | - | - | 1 | 1 | I |
| 18-8 | - | - | - | - | - | - | 8 | - | 1 | 1 | I |
| 18-11 | 62 | 119 | 241 | 340 | - | 11 | - | - | 1 | - | II |
| 18-32 | 85 | 138 | 222 | 265 | 32 | - | - | - | 1 | 1 | I |
| 18-918 | - | - | - | - | 16 | - | - | 2 | 1 | - | I |
| 20-16 | 238 | 318 | 333 | 347 | - | 16 | - | - | 1 | 1 | II |
| 20-39 | 63 | 144 | 252 | 333 | 37 | 2 | - | - | 1 | 1 | I |
| 20-41 | 45 | 126 | 225 | - | 41 | - | - | - | 1 | 1 | I |
| 22-12 | - | - | - | - | - | - | 12 | - | 1 | - | I |
| 22-21 | 16 | 135 | 175 | 349 | - | 21 | - | - | 1 | - | II |
| 22-32 | 72 | 145 | 215 | 288 | 32 | - | - | - | 1 | - | I |
| 22-41 | 39 | 135 | 264 | - | 27 | 14 | - | - | 1 | 1 | I |
| 22-55 | 30 | 142 | 226 | 314 | 55 | - | - | - | 1 | 1 | I |
| 24-19 | 30 | 165 | 315 | - | - | - | 19 | - | 1 | - | II |
| 24-31 | 90 | 225 | - | - | - | 31 | - | - | 1 | - | I |
| 24-37 | 25 | 50 | 75 | - | - | 37 | - | - | 1 | - | I |
| 24-53 | - | - | - | - | 51 | - | - | 2 | 1 | - | I |
| 24-61 | 90 | 180 | 270 | 324 | 61 | - | - | - | 1 | 1 | I |
| 24-100 | 45 | 90 | 135 | - | - | - | - | 10 | - | - | I |

Male insert, front face view or female insert, wiring side view.



Disposition 08-3A
3 contacts size 20



Disposition 08-33
3 contacts size 20



Disposition 08-98
3 contacts size 20



Disposition 10-6
6 contacts size 20

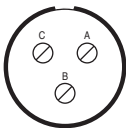

Disposition 12-3
3 contacts size 16

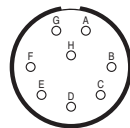

Disposition 12-8 *
8 contacts size 20

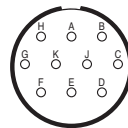

Disposition 12-10
10 contacts size 20

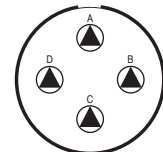

Disposition 14-4
4 contacts size 12



Disposition 14-5
5 contacts size 16



Disposition 14-12
8 contacts size 20
4 contacts size 16



Disposition 14-15
14 contacts size 20
1 contact size 16



Disposition 14-18 *
18 contacts size 20



Disposition 14-19
19 contacts size 20

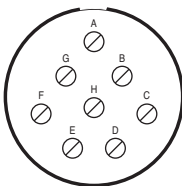

Disposition 16-8
8 contacts size 16

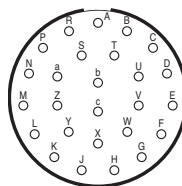

Disposition 16-26
26 contacts size 20



Disposition 18-8
8 contacts size 12

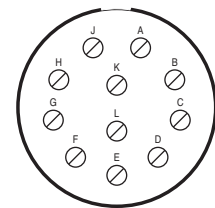

Disposition 18-11
11 contacts size 16

* Consult us

Male insert, front face view or female insert, wiring side view.



Disposition 18-32
32 contacts size 20



Disposition 18-918 *
16 contacts size 20
2 contacts size 8 or coax



Disposition 20-16
16 contacts size 16

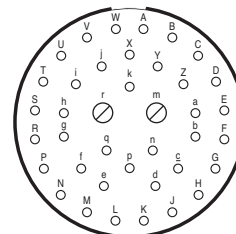

Disposition 20-39
37 contacts size 20
2 contacts size 16

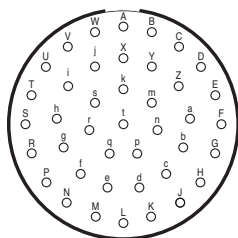

Disposition 20-41 *
41 contacts size 20

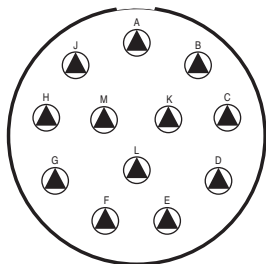

Disposition 22-12
12 contacts size 12

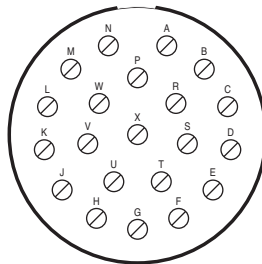

Disposition 22-21 *
21 contacts size 16

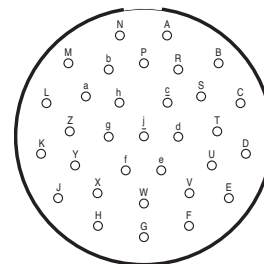

Disposition 22-32 *
32 contacts size 20



Disposition 22-41
27 contacts size 20
14 contacts size 16

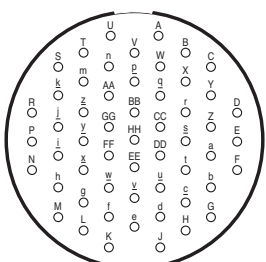

Disposition 22-55
55 contacts size 20

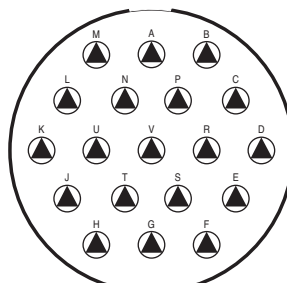

Disposition 24-19
19 contacts size 12

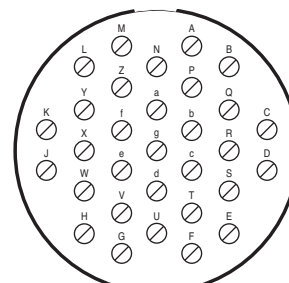

Disposition 24-31
31 contacts size 16



Disposition 24-37 *
37 contacts size 16



Disposition 24-53 *
51 contacts size 20
2 coax or size 8



Disposition 24-61
61 contacts size 20

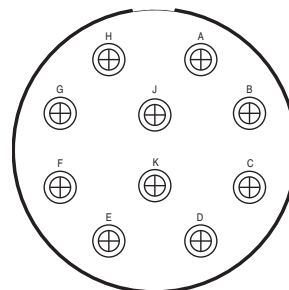

Disposition 24-100 *
10 coax or size 8

* Consult us

Square flange



With backshell
Nickel plating without Mod.
Olive drab cadmium plating Mod. A 231



Without backshell
Nickel plating Mod. 1A
Olive drab cadmium plating Mod. A 5324



| Nickel Plating Reference | B max. | C ± 0,1 | D ± 0,15 | E max. | F max. | G max. | G1 max. | L max. | L1 max. | P max. | Olive Drab Cadmium Plating Reference |
|--------------------------|--------|---------|----------|--------|--------|--------|---------|--------|---------|--------|--------------------------------------|
| AFD 50-08-**-P/S-* | 21,00 | 15,08 | 11,13 | 1,95 | 12,03 | 15,65 | 12,70 | 36,85 | 30,85 | 7,75 | AFD 50-08-**-P/S-* |
| AFD 50-10-**-P/S-* | 24,20 | 18,26 | 11,13 | 1,95 | 15,01 | 18,60 | 15,85 | 36,85 | 30,85 | 10,29 | AFD 50-10-**-P/S-* |
| AFD 50-12-**-P/S-* | 26,55 | 20,62 | 11,13 | 1,95 | 19,07 | 21,75 | 19,05 | 36,85 | 30,85 | 13,49 | AFD 50-12-**-P/S-* |
| AFD 50-14-**-P/S-* | 28,95 | 23,02 | 11,13 | 1,95 | 22,24 | 24,95 | 22,20 | 36,85 | 30,85 | 16,89 | AFD 50-14-**-P/S-* |
| AFD 50-16-**-P/S-* | 31,30 | 24,58 | 11,13 | 1,95 | 25,42 | 28,20 | 25,40 | 36,85 | 30,85 | 20,07 | AFD 50-16-**-P/S-* |
| AFD 50-18-**-P/S-* | 33,70 | 26,98 | 11,13 | 1,95 | 28,60 | 30,90 | 26,95 | 36,85 | 30,85 | 22,07 | AFD 50-18-**-P/S-* |
| AFD 50-20-**-P/S-* | 36,85 | 29,36 | 14,30 | 2,55 | 31,77 | 34,15 | 30,15 | 38,40 | 32,35 | 25,25 | AFD 50-20-**-P/S-* |
| AFD 50-22-**-P/S-* | 39,95 | 31,76 | 14,30 | 2,55 | 34,94 | 37,25 | 33,30 | 38,40 | 32,35 | 28,42 | AFD 50-22-**-P/S-* |
| AFD 50-24-**-P/S-* | 43,15 | 34,92 | 15,10 | 2,55 | 38,12 | 40,45 | 36,50 | 38,40 | 32,35 | 31,60 | AFD 50-24-**-P/S-* |

Mounting styles

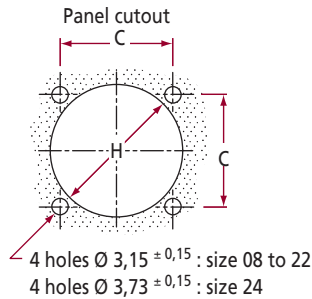

| Size | C ± 0,1 | H +0 -0,2 | E max. |
|------|---------|-----------|--------|
| 08 | 15,08 | 16,05 | 2,50 |
| 10 | 18,26 | 19,00 | 2,50 |
| 12 | 20,62 | 22,25 | 2,50 |
| 14 | 23,02 | 25,40 | 2,50 |
| 16 | 24,58 | 28,60 | 2,50 |
| 18 | 26,98 | 31,75 | 2,50 |
| 20 | 29,36 | 34,90 | 5,40 |
| 22 | 31,76 | 38,10 | 5,40 |
| 24 | 34,92 | 41,30 | 5,40 |

Flat gasket for square flange

To order apart

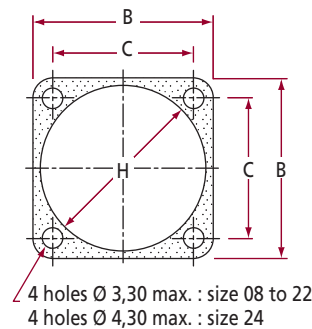

| Front Flange Mounting | | | | | Rear Flange Mounting | | | | |
|-----------------------|-------------------|--------|--------|---------|----------------------|--------|-------------------|------|--|
| Size | Reference | H max. | B max. | C ± 0,1 | E max. | H max. | Reference | Size | |
| 08 | 108-0003-08-A 624 | 12,50 | 21,00 | 15,08 | 2,50 | 13,20 | 108-0001-08-A 624 | 08 | |
| 10 | 108-0003-10-A 624 | 15,40 | 24,20 | 18,26 | 2,50 | 16,40 | 108-0001-10-A 624 | 10 | |
| 12 | 108-0001-12-A 624 | 19,50 | 26,55 | 20,62 | 2,50 | 19,50 | 108-0001-12-A 624 | 12 | |
| 14 | 108-0001-14-A 624 | 22,70 | 28,95 | 23,02 | 2,50 | 22,70 | 108-0001-14-A 624 | 14 | |
| 16 | 108-0001-16-A 624 | 25,90 | 31,30 | 24,58 | 2,50 | 25,90 | 108-0001-16-A 624 | 16 | |
| 18 | 108-0003-18-A 624 | 29,10 | 33,70 | 26,98 | 2,50 | 27,50 | 108-0001-18-A 624 | 18 | |
| 20 | 108-0003-20-A 624 | 32,30 | 36,85 | 29,36 | 5,40 | 30,60 | 108-0001-20-A 624 | 20 | |
| 22 | 108-0003-22-A 624 | 35,40 | 39,95 | 31,75 | 5,40 | 33,50 | 108-0001-22-A 624 | 22 | |
| 24 | 108-0003-24-A 624 | 38,60 | 43,15 | 34,92 | 5,40 | 37,00 | 108-0001-24-A 624 | 24 | |

■ Square flange

● With straight cable clamp



| Nickel Plating Reference | G max. | J mini. | J1 max. | L max. | Olive Drab Cadmium Plating Reference |
|--------------------------|--------|---------|---------|--------|--------------------------------------|
| AFD 50-08-**-P/S-* 059 | 15,65 | 6,80 | 5,15 | 45,85 | AFD 50-08-**-P/S-* A 5347 |
| AFD 50-10-**-P/S-* 059 | 18,60 | 9,30 | 7,25 | 45,85 | AFD 50-10-**-P/S-* A 5347 |
| AFD 50-12-**-P/S-* 059 | 21,75 | 12,75 | 10,55 | 45,85 | AFD 50-12-**-P/S-* A 5347 |
| AFD 50-14-**-P/S-* 059 | 24,95 | 14,65 | 12,05 | 51,85 | AFD 50-14-**-P/S-* A 5347 |
| AFD 50-16-**-P/S-* 059 | 28,20 | 17,80 | 15,85 | 51,85 | AFD 50-16-**-P/S-* A 5347 |
| AFD 50-18-**-P/S-* 059 | 30,90 | 19,80 | 17,90 | 51,85 | AFD 50-18-**-P/S-* A 5347 |
| AFD 50-20-**-P/S-* 059 | 34,15 | 23,00 | 21,05 | 53,35 | AFD 50-20-**-P/S-* A 5347 |
| AFD 50-22-**-P/S-* 059 | 37,25 | 26,15 | 24,25 | 53,35 | AFD 50-22-**-P/S-* A 5347 |
| AFD 50-24-**-P/S-* 059 | 40,45 | 29,10 | 27,45 | 53,35 | AFD 50-24-**-P/S-* A 5347 |

● With 90° end bell cable clamp



| Nickel Plating Reference | G max. | J mini. | J1 max. | L max. | T max. | Olive Drab Cadmium Plating Reference |
|--------------------------|--------|---------|---------|--------|--------|--------------------------------------|
| AFD 50-08-**-P/S-* 081 | 15,65 | 6,80 | 5,15 | 49,30 | 20,70 | AFD 50-08-**-P/S-* A 5543 |
| AFD 50-10-**-P/S-* 081 | 18,60 | 9,30 | 7,25 | 51,65 | 22,00 | AFD 50-10-**-P/S-* A 5543 |
| AFD 50-12-**-P/S-* 081 | 21,75 | 12,75 | 10,55 | 54,10 | 23,80 | AFD 50-12-**-P/S-* A 5543 |
| AFD 50-14-**-P/S-* 081 | 24,95 | 14,65 | 12,05 | 57,35 | 25,30 | AFD 50-14-**-P/S-* A 5543 |
| AFD 50-16-**-P/S-* 081 | 28,20 | 17,80 | 15,85 | 60,75 | 26,80 | AFD 50-16-**-P/S-* A 5543 |
| AFD 50-18-**-P/S-* 081 | 30,90 | 19,80 | 17,90 | 64,20 | 28,30 | AFD 50-18-**-P/S-* A 5543 |
| AFD 50-20-**-P/S-* 081 | 34,15 | 23,00 | 21,05 | 69,05 | 29,90 | AFD 50-20-**-P/S-* A 5543 |
| AFD 50-22-**-P/S-* 081 | 37,25 | 26,15 | 24,25 | 72,15 | 31,60 | AFD 50-22-**-P/S-* A 5543 |
| AFD 50-24-**-P/S-* 081 | 40,45 | 29,10 | 27,45 | 75,25 | 33,20 | AFD 50-24-**-P/S-* A 5543 |

● With potting cup



| Nickel Plating Reference | G max. | J mini. | L max. | Olive Drab Cadmium Plating Reference |
|--------------------------|--------|---------|--------|--------------------------------------|
| AFD 50-08-**-P/S-* 083 | 15,65 | 4,60 | 44,70 | AFD 50-08-**-P/S-* A 5629 |
| AFD 50-10-**-P/S-* 083 | 18,60 | 6,60 | 44,70 | AFD 50-10-**-P/S-* A 5629 |
| AFD 50-12-**-P/S-* 083 | 21,75 | 10,00 | 44,70 | AFD 50-12-**-P/S-* A 5629 |
| AFD 50-14-**-P/S-* 083 | 24,95 | 11,50 | 50,20 | AFD 50-14-**-P/S-* A 5629 |
| AFD 50-16-**-P/S-* 083 | 28,20 | 15,30 | 50,20 | AFD 50-16-**-P/S-* A 5629 |
| AFD 50-18-**-P/S-* 083 | 30,90 | 17,30 | 50,20 | AFD 50-18-**-P/S-* A 5629 |
| AFD 50-20-**-P/S-* 083 | 34,15 | 20,50 | 51,70 | AFD 50-20-**-P/S-* A 5629 |
| AFD 50-22-**-P/S-* 083 | 37,25 | 23,70 | 51,70 | AFD 50-22-**-P/S-* A 5629 |
| AFD 50-24-**-P/S-* 083 | 40,45 | 26,80 | 51,70 | AFD 50-24-**-P/S-* A 5629 |

● Fitting for thermo-shrink sleeve



| Nickel Plating Reference | G max. | J mini. | L max. | P max. | S max. | Olive Drab Cadmium Plating Reference |
|--------------------------|--------|---------|--------|--------|--------|--------------------------------------|
| AFD 50-08-**-P/S-* A 315 | 15,65 | 6,50 | 46,55 | 13,55 | 7,80 | AFD 50-08-**-P/S-* A 5563 |
| AFD 50-10-**-P/S-* A 315 | 18,60 | 9,20 | 46,55 | 15,40 | 7,80 | AFD 50-10-**-P/S-* A 5563 |
| AFD 50-12-**-P/S-* A 315 | 21,75 | 12,65 | 46,55 | 19,70 | 7,80 | AFD 50-12-**-P/S-* A 5563 |
| AFD 50-14-**-P/S-* A 315 | 24,95 | 14,50 | 46,55 | 21,30 | 7,80 | AFD 50-14-**-P/S-* A 5563 |
| AFD 50-16-**-P/S-* A 315 | 28,20 | 17,70 | 46,55 | 24,50 | 7,80 | AFD 50-16-**-P/S-* A 5563 |
| AFD 50-18-**-P/S-* A 315 | 30,90 | 19,70 | 46,55 | 26,50 | 7,80 | AFD 50-18-**-P/S-* A 5563 |
| AFD 50-20-**-P/S-* A 315 | 34,15 | 22,90 | 50,35 | 30,95 | 10,08 | AFD 50-20-**-P/S-* A 5563 |
| AFD 50-22-**-P/S-* A 315 | 37,25 | 26,05 | 51,00 | 34,45 | 10,65 | AFD 50-22-**-P/S-* A 5563 |
| AFD 50-24-**-P/S-* A 315 | 40,45 | 29,00 | 51,00 | 36,65 | 10,65 | AFD 50-24-**-P/S-* A 5563 |

● With grounding adaptor

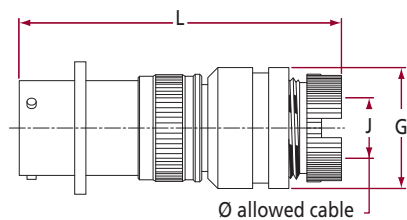

| Nickel Plating Reference | G max. | J mini. | L max. | Olive Drab Cadmium Plating Reference |
|--------------------------|--------|---------|--------|--------------------------------------|
| AFD 50-08-**-P/S-* A 564 | 18,00 | 6,80 | 65,90 | AFD 50-08-**-P/S-* A 5534 |
| AFD 50-10-**-P/S-* A 564 | 20,10 | 9,30 | 65,70 | AFD 50-10-**-P/S-* A 5534 |
| AFD 50-12-**-P/S-* A 564 | 24,40 | 12,75 | 65,60 | AFD 50-12-**-P/S-* A 5534 |
| AFD 50-14-**-P/S-* A 564 | 27,50 | 14,65 | 65,80 | AFD 50-14-**-P/S-* A 5534 |
| AFD 50-16-**-P/S-* A 564 | 30,85 | 17,80 | 65,60 | AFD 50-16-**-P/S-* A 5534 |
| AFD 50-18-**-P/S-* A 564 | 33,90 | 19,80 | 64,90 | AFD 50-18-**-P/S-* A 5534 |
| AFD 50-20-**-P/S-* A 564 | 37,10 | 23,00 | 67,25 | AFD 50-20-**-P/S-* A 5534 |
| AFD 50-22-**-P/S-* A 564 | 40,20 | 26,15 | 67,35 | AFD 50-22-**-P/S-* A 5534 |
| AFD 50-24-**-P/S-* A 564 | 43,40 | 29,10 | 68,00 | AFD 50-24-**-P/S-* A 5534 |

Note : L dimension calculated for a braid of 1 m/m thickness

Single hole mounting



With backshell
Nickel plating without Mod.
Olive drab cadmium plating Mod. A 231

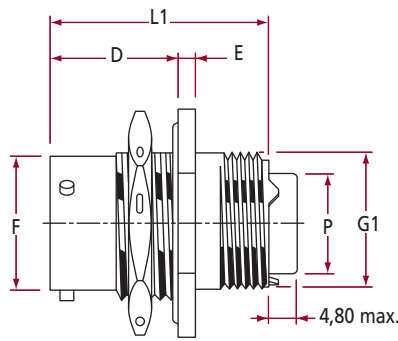

Without backshell
Nickel plating Mod. 1A
Olive drab cadmium plating Mod. A 5324



| Nickel Plating Reference | A max. | B max. ± 0,15 | D max. | E max. | F max. | G max. | G1 max. | L max. | L1 max. | M max. | P max. | Olive Drab Cadmium Plating Reference | | |
|--------------------------|-----------|---------------|--------|--------|--------|--------|---------|--------|---------|--------|--------|--------------------------------------|-------|--------|
| AFD 54-08-**-P/S-* | 1 A 27,35 | 24,20 | 17,78 | 2,85 | 12,03 | 15,65 | 12,70 | 36,85 | 30,85 | 19,20 | 7,75 | AFD 54-08-**-P/S-* | A 231 | A 5324 |
| AFD 54-10-**-P/S-* | 1 A 30,55 | 27,35 | 17,78 | 2,85 | 15,01 | 18,60 | 15,85 | 36,85 | 30,85 | 22,37 | 10,29 | AFD 54-10-**-P/S-* | A 231 | A 5324 |
| AFD 54-12-**-P/S-* | 1 A 35,30 | 32,15 | 17,78 | 2,85 | 19,07 | 21,75 | 19,05 | 36,85 | 30,85 | 27,12 | 13,49 | AFD 54-12-**-P/S-* | A 231 | A 5324 |
| AFD 54-14-**-P/S-* | 1 A 38,50 | 35,30 | 17,78 | 2,85 | 22,24 | 24,95 | 22,20 | 36,85 | 30,85 | 30,30 | 16,89 | AFD 54-14-**-P/S-* | A 231 | A 5324 |
| AFD 54-16-**-P/S-* | 1 A 41,65 | 38,50 | 17,78 | 2,85 | 25,42 | 28,20 | 25,40 | 36,85 | 30,85 | 33,47 | 20,07 | AFD 54-16-**-P/S-* | A 231 | A 5324 |
| AFD 54-18-**-P/S-* | 1 A 44,80 | 41,65 | 17,78 | 2,85 | 28,60 | 30,90 | 26,95 | 36,85 | 30,85 | 36,67 | 22,07 | AFD 54-18-**-P/S-* | A 231 | A 5324 |
| AFD 54-20-**-P/S-* | 1 A 49,60 | 46,40 | 19,43 | 3,70 | 31,77 | 34,15 | 30,15 | 38,40 | 32,35 | 39,82 | 25,25 | AFD 54-20-**-P/S-* | A 231 | A 5324 |
| AFD 54-22-**-P/S-* | 1 A 52,75 | 49,60 | 19,43 | 3,70 | 34,94 | 37,25 | 33,30 | 38,40 | 32,35 | 43,02 | 28,42 | AFD 54-22-**-P/S-* | A 231 | A 5324 |
| AFD 54-24-**-P/S-* | 1 A 55,95 | 52,75 | 19,43 | 3,70 | 38,12 | 40,45 | 36,50 | 38,40 | 32,35 | 46,17 | 31,60 | AFD 54-24-**-P/S-* | A 231 | A 5324 |

Mounting styles

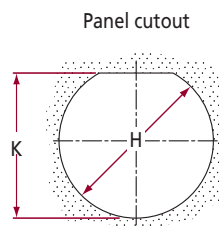

| Size | E max. | H +0 -0,2 | K +0 -0,2 | Tightening torque |
|------|--------|-----------|-----------|-------------------|
| 08 | 4,30 | 14,65 | 13,85 | 7,5 mN |
| 10 | 4,30 | 17,80 | 17,05 | 10 mN |
| 12 | 4,30 | 22,55 | 21,15 | 13 mN |
| 14 | 4,30 | 25,70 | 24,30 | 15 mN |
| 16 | 4,30 | 28,90 | 27,45 | 18 mN |
| 18 | 4,30 | 32,05 | 30,65 | 21 mN |
| 20 | 6,35 | 35,25 | 33,80 | 23 mN |
| 22 | 6,35 | 38,40 | 37,00 | 26 mN |
| 24 | 6,35 | 41,60 | 40,15 | 29 mN |

Panel nut

| Size | Reference | Olive drab Cadmium | Nickel |
|------|-------------|--------------------|--------|
| 08 | 006-0980-08 | A 231 | A 499 |
| 10 | 006-0980-10 | A 231 | A 499 |
| 12 | 006-0980-12 | A 231 | A 499 |
| 14 | 006-0980-14 | A 231 | A 499 |
| 16 | 006-0980-16 | A 231 | A 499 |
| 18 | 006-0980-18 | A 231 | A 499 |
| 20 | 006-0980-20 | A 231 | A 499 |
| 22 | 006-0980-22 | A 231 | A 499 |
| 24 | 006-0980-24 | A 231 | A 499 |

For single hole mounting receptacle

O'ring panel

| Size | Reference |
|------|----------------|
| 08 | 103-0001-16-02 |
| 10 | 103-0001-18-02 |
| 12 | 103-0001-21-02 |
| 14 | 103-0001-23-02 |
| 16 | 103-0001-25-02 |
| 18 | 103-0001-27-02 |
| 20 | 103-0001-29-02 |
| 22 | 103-0001-30-02 |
| 24 | 103-0001-31-02 |

Single hole mounting

• With straight cable clamp

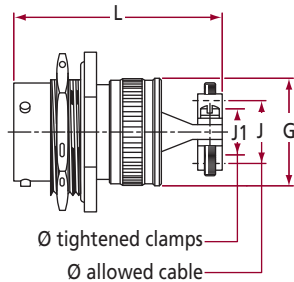

| Nickel Plating Reference | G max. | J mini. | J1 max. | L max. | Olive Drab Cadmium Plating Reference |
|--------------------------|--------|---------|---------|--------|--------------------------------------|
| AFD 54-08-**-P/S-* 059 | 15,65 | 6,80 | 5,15 | 45,85 | AFD 54-08-**-P/S-* A 5347 |
| AFD 54-10-**-P/S-* 059 | 18,60 | 9,30 | 7,25 | 45,85 | AFD 54-10-**-P/S-* A 5347 |
| AFD 54-12-**-P/S-* 059 | 21,75 | 12,75 | 10,55 | 45,85 | AFD 54-12-**-P/S-* A 5347 |
| AFD 54-14-**-P/S-* 059 | 24,95 | 14,65 | 12,05 | 51,85 | AFD 54-14-**-P/S-* A 5347 |
| AFD 54-16-**-P/S-* 059 | 28,20 | 17,80 | 15,85 | 51,85 | AFD 54-16-**-P/S-* A 5347 |
| AFD 54-18-**-P/S-* 059 | 30,90 | 19,80 | 17,90 | 51,85 | AFD 54-18-**-P/S-* A 5347 |
| AFD 54-20-**-P/S-* 059 | 34,15 | 23,00 | 21,05 | 53,35 | AFD 54-20-**-P/S-* A 5347 |
| AFD 54-22-**-P/S-* 059 | 37,25 | 26,15 | 24,25 | 53,35 | AFD 54-22-**-P/S-* A 5347 |
| AFD 54-24-**-P/S-* 059 | 40,45 | 29,10 | 27,45 | 53,35 | AFD 54-24-**-P/S-* A 5347 |

• With 90° end bell cable clamp

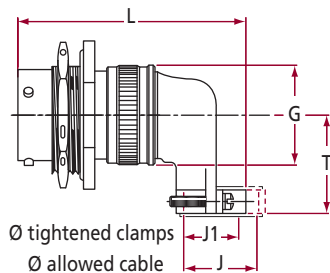

| Nickel Plating Reference | G max. | J mini. | J1 max. | L max. | T max. | Olive Drab Cadmium Plating Reference |
|--------------------------|--------|---------|---------|--------|--------|--------------------------------------|
| AFD 54-08-**-P/S-* 081 | 15,65 | 6,80 | 5,15 | 49,30 | 20,70 | AFD 54-08-**-P/S-* A 5543 |
| AFD 54-10-**-P/S-* 081 | 18,60 | 9,30 | 7,25 | 51,65 | 22,00 | AFD 54-10-**-P/S-* A 5543 |
| AFD 54-12-**-P/S-* 081 | 21,75 | 12,75 | 10,55 | 54,10 | 23,80 | AFD 54-12-**-P/S-* A 5543 |
| AFD 54-14-**-P/S-* 081 | 24,95 | 14,65 | 12,05 | 57,35 | 25,30 | AFD 54-14-**-P/S-* A 5543 |
| AFD 54-16-**-P/S-* 081 | 28,20 | 17,80 | 15,85 | 60,75 | 26,80 | AFD 54-16-**-P/S-* A 5543 |
| AFD 54-18-**-P/S-* 081 | 30,90 | 19,80 | 17,90 | 64,20 | 28,30 | AFD 54-18-**-P/S-* A 5543 |
| AFD 54-20-**-P/S-* 081 | 34,15 | 23,00 | 21,05 | 69,05 | 29,90 | AFD 54-20-**-P/S-* A 5543 |
| AFD 54-22-**-P/S-* 081 | 37,25 | 26,15 | 24,25 | 72,15 | 31,60 | AFD 54-22-**-P/S-* A 5543 |
| AFD 54-24-**-P/S-* 081 | 40,45 | 29,10 | 27,45 | 75,25 | 33,20 | AFD 54-24-**-P/S-* A 5543 |

• With potting cup

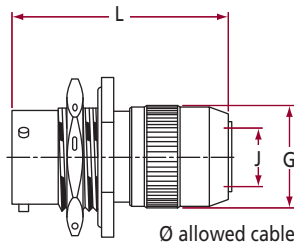

| Nickel Plating Reference | G max. | J mini. | L max. | Olive Drab Cadmium Plating Reference |
|--------------------------|--------|---------|--------|--------------------------------------|
| AFD 54-08-**-P/S-* 083 | 15,65 | 4,60 | 44,70 | AFD 54-08-**-P/S-* A 5629 |
| AFD 54-10-**-P/S-* 083 | 18,60 | 6,60 | 44,70 | AFD 54-10-**-P/S-* A 5629 |
| AFD 54-12-**-P/S-* 083 | 21,75 | 10,00 | 44,70 | AFD 54-12-**-P/S-* A 5629 |
| AFD 54-14-**-P/S-* 083 | 24,95 | 11,50 | 50,20 | AFD 54-14-**-P/S-* A 5629 |
| AFD 54-16-**-P/S-* 083 | 28,20 | 15,30 | 50,20 | AFD 54-16-**-P/S-* A 5629 |
| AFD 54-18-**-P/S-* 083 | 30,90 | 17,30 | 50,20 | AFD 54-18-**-P/S-* A 5629 |
| AFD 54-20-**-P/S-* 083 | 34,15 | 20,50 | 51,70 | AFD 54-20-**-P/S-* A 5629 |
| AFD 54-22-**-P/S-* 083 | 37,25 | 23,70 | 51,70 | AFD 54-22-**-P/S-* A 5629 |
| AFD 54-24-**-P/S-* 083 | 40,45 | 26,80 | 51,70 | AFD 54-24-**-P/S-* A 5629 |

• Fitting for thermo-shrink sleeve

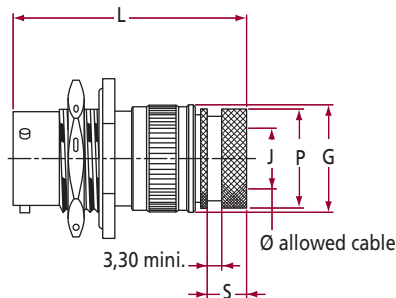

| Nickel Plating Reference | G max. | J max. | L max. | P max. | S max. | Olive Drab Cadmium Plating Reference |
|--------------------------|--------|--------|--------|--------|--------|--------------------------------------|
| AFD 54-08-**-P/S-* A 315 | 15,65 | 6,50 | 46,55 | 13,55 | 7,80 | AFD 54-08-**-P/S-* A 5563 |
| AFD 54-10-**-P/S-* A 315 | 18,60 | 9,20 | 46,55 | 15,40 | 7,80 | AFD 54-10-**-P/S-* A 5563 |
| AFD 54-12-**-P/S-* A 315 | 21,75 | 12,65 | 46,55 | 19,70 | 7,80 | AFD 54-12-**-P/S-* A 5563 |
| AFD 54-14-**-P/S-* A 315 | 24,95 | 14,50 | 46,55 | 21,30 | 7,80 | AFD 54-14-**-P/S-* A 5563 |
| AFD 54-16-**-P/S-* A 315 | 28,20 | 17,70 | 46,55 | 24,50 | 7,80 | AFD 54-16-**-P/S-* A 5563 |
| AFD 54-18-**-P/S-* A 315 | 30,90 | 19,70 | 46,55 | 26,50 | 7,80 | AFD 54-18-**-P/S-* A 5563 |
| AFD 54-20-**-P/S-* A 315 | 34,15 | 22,90 | 50,35 | 30,95 | 10,08 | AFD 54-20-**-P/S-* A 5563 |
| AFD 54-22-**-P/S-* A 315 | 37,25 | 26,05 | 51,00 | 34,45 | 10,65 | AFD 54-22-**-P/S-* A 5563 |
| AFD 54-24-**-P/S-* A 315 | 40,45 | 29,00 | 51,00 | 36,65 | 10,65 | AFD 54-24-**-P/S-* A 5563 |

• With grounding adaptor

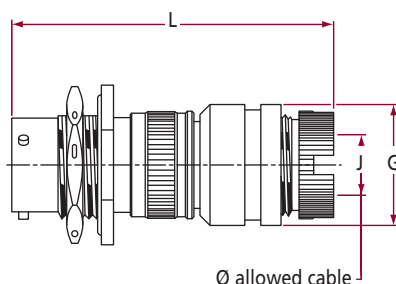

| Nickel Plating Reference | G max. | J mini. | L max. | Olive Drab Cadmium Plating Reference |
|--------------------------|--------|---------|--------|--------------------------------------|
| AFD 54-08-**-P/S-* A 564 | 18,00 | 6,80 | 65,90 | AFD 54-08-**-P/S-* A 5534 |
| AFD 54-10-**-P/S-* A 564 | 20,10 | 9,30 | 65,70 | AFD 54-10-**-P/S-* A 5534 |
| AFD 54-12-**-P/S-* A 564 | 24,40 | 12,75 | 65,60 | AFD 54-12-**-P/S-* A 5534 |
| AFD 54-14-**-P/S-* A 564 | 27,50 | 14,65 | 65,80 | AFD 54-14-**-P/S-* A 5534 |
| AFD 54-16-**-P/S-* A 564 | 30,85 | 17,80 | 65,60 | AFD 54-16-**-P/S-* A 5534 |
| AFD 54-18-**-P/S-* A 564 | 33,90 | 19,80 | 64,90 | AFD 54-18-**-P/S-* A 5534 |
| AFD 54-20-**-P/S-* A 564 | 37,10 | 23,00 | 67,25 | AFD 54-20-**-P/S-* A 5534 |
| AFD 54-22-**-P/S-* A 564 | 40,20 | 26,15 | 67,35 | AFD 54-22-**-P/S-* A 5534 |
| AFD 54-24-**-P/S-* A 564 | 43,40 | 29,10 | 68,00 | AFD 54-24-**-P/S-* A 5534 |

Note : L dimension calculated for a braid of 1 m/m thickness

Plugs



Without backshell
 Nickel plating Mod. 1A
 Olive drab cadmium plating Mod. A 5324

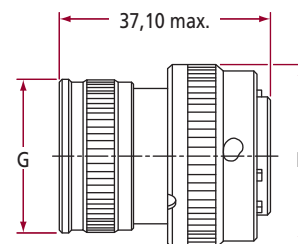

With backshell
 Nickel plating without Mod.
 Olive drab cadmium plating Mod. A 231

| Nickel Plating Reference | F max. | G max. | G1 max. | P max. | Olive Drab Cadmium Plating Reference |
|--------------------------|-----------|--------|---------|--------|--------------------------------------|
| AFD 56-08-**-P/S-* | 1 A 19,75 | 15,65 | 12,70 | 7,75 | AFD 56-08-**-P/S-* |
| AFD 56-10-**-P/S-* | 1 A 22,70 | 18,60 | 15,85 | 10,29 | AFD 56-10-**-P/S-* |
| AFD 56-12-**-P/S-* | 1 A 26,45 | 21,75 | 19,05 | 13,49 | AFD 56-12-**-P/S-* |
| AFD 56-14-**-P/S-* | 1 A 29,95 | 24,95 | 22,20 | 16,89 | AFD 56-14-**-P/S-* |
| AFD 56-16-**-P/S-* | 1 A 32,95 | 28,20 | 25,40 | 20,07 | AFD 56-16-**-P/S-* |
| AFD 56-18-**-P/S-* | 1 A 35,30 | 30,90 | 26,95 | 22,07 | AFD 56-18-**-P/S-* |
| AFD 56-20-**-P/S-* | 1 A 38,85 | 34,15 | 30,15 | 25,25 | AFD 56-20-**-P/S-* |
| AFD 56-22-**-P/S-* | 1 A 42,05 | 37,25 | 33,30 | 28,42 | AFD 56-22-**-P/S-* |
| AFD 56-24-**-P/S-* | 1 A 45,05 | 40,45 | 36,50 | 31,60 | AFD 56-24-**-P/S-* |

• With straight cable clamp



| Nickel Plating Reference | G max. | J mini. | J1 max. | L max. | Olive Drab Cadmium Plating Reference |
|--------------------------|--------|---------|---------|--------|--------------------------------------|
| AFD 56-08-**-P/S-* 059 | 15,65 | 6,80 | 5,15 | 46,10 | AFD 56-08-**-P/S-* A 5347 |
| AFD 56-10-**-P/S-* 059 | 18,60 | 9,30 | 7,25 | 46,10 | AFD 56-10-**-P/S-* A 5347 |
| AFD 56-12-**-P/S-* 059 | 21,75 | 12,75 | 10,55 | 46,10 | AFD 56-12-**-P/S-* A 5347 |
| AFD 56-14-**-P/S-* 059 | 24,95 | 14,65 | 12,05 | 52,10 | AFD 56-14-**-P/S-* A 5347 |
| AFD 56-16-**-P/S-* 059 | 28,20 | 17,80 | 15,85 | 52,10 | AFD 56-16-**-P/S-* A 5347 |
| AFD 56-18-**-P/S-* 059 | 30,90 | 19,80 | 17,90 | 52,10 | AFD 56-18-**-P/S-* A 5347 |
| AFD 56-20-**-P/S-* 059 | 34,15 | 23,00 | 21,05 | 52,10 | AFD 56-20-**-P/S-* A 5347 |
| AFD 56-22-**-P/S-* 059 | 37,25 | 26,15 | 24,25 | 52,10 | AFD 56-22-**-P/S-* A 5347 |
| AFD 56-24-**-P/S-* 059 | 40,45 | 29,10 | 27,45 | 52,10 | AFD 56-24-**-P/S-* A 5347 |

• With 90° end bell cable clamp



| Nickel Plating Reference | G max. | J mini. | J1 max. | L max. | T max. | Olive Drab Cadmium Plating Reference |
|--------------------------|--------|---------|---------|--------|--------|--------------------------------------|
| AFD 56-08-**-P/S-* 081 | 15,65 | 6,80 | 5,15 | 49,55 | 20,70 | AFD 56-08-**-P/S-* A 5543 |
| AFD 56-10-**-P/S-* 081 | 18,60 | 9,30 | 7,25 | 51,90 | 22,00 | AFD 56-10-**-P/S-* A 5543 |
| AFD 56-12-**-P/S-* 081 | 21,75 | 12,75 | 10,55 | 55,35 | 23,80 | AFD 56-12-**-P/S-* A 5543 |
| AFD 56-14-**-P/S-* 081 | 24,95 | 14,65 | 12,05 | 57,60 | 25,30 | AFD 56-14-**-P/S-* A 5543 |
| AFD 56-16-**-P/S-* 081 | 28,20 | 17,80 | 15,85 | 61,00 | 26,80 | AFD 56-16-**-P/S-* A 5543 |
| AFD 56-18-**-P/S-* 081 | 30,90 | 19,80 | 17,90 | 64,45 | 28,30 | AFD 56-18-**-P/S-* A 5543 |
| AFD 56-20-**-P/S-* 081 | 34,15 | 23,00 | 21,05 | 67,80 | 29,90 | AFD 56-20-**-P/S-* A 5543 |
| AFD 56-22-**-P/S-* 081 | 37,25 | 26,15 | 24,25 | 70,90 | 31,60 | AFD 56-22-**-P/S-* A 5543 |
| AFD 56-24-**-P/S-* 081 | 40,45 | 29,10 | 27,45 | 74,00 | 33,20 | AFD 56-24-**-P/S-* A 5543 |

• With potting cup



| Nickel Plating Reference | G max. | J mini. | L max. | Olive Drab Cadmium Plating Reference |
|--------------------------|--------|---------|--------|--------------------------------------|
| AFD 56-08-**-P/S-* 083 | 15,65 | 4,60 | 45,45 | AFD 56-08-**-P/S-* A 5629 |
| AFD 56-10-**-P/S-* 083 | 18,60 | 6,60 | 45,45 | AFD 56-10-**-P/S-* A 5629 |
| AFD 56-12-**-P/S-* 083 | 21,75 | 10,00 | 45,45 | AFD 56-12-**-P/S-* A 5629 |
| AFD 56-14-**-P/S-* 083 | 24,95 | 11,50 | 50,95 | AFD 56-14-**-P/S-* A 5629 |
| AFD 56-16-**-P/S-* 083 | 28,20 | 15,30 | 50,95 | AFD 56-16-**-P/S-* A 5629 |
| AFD 56-18-**-P/S-* 083 | 30,90 | 17,30 | 50,95 | AFD 56-18-**-P/S-* A 5629 |
| AFD 56-20-**-P/S-* 083 | 34,15 | 20,50 | 50,95 | AFD 56-20-**-P/S-* A 5629 |
| AFD 56-22-**-P/S-* 083 | 37,25 | 23,70 | 50,95 | AFD 56-22-**-P/S-* A 5629 |
| AFD 56-24-**-P/S-* 083 | 40,45 | 26,80 | 50,95 | AFD 56-24-**-P/S-* A 5629 |

• Fitting for thermo-shrink sleeve



| Nickel Plating Reference | G max. | J max. | L max. | P max. | S max. | Olive Drab Cadmium Plating Reference |
|--------------------------|--------|--------|--------|--------|--------|--------------------------------------|
| AFD 56-08-**-P/S-* A 315 | 15,65 | 6,50 | 46,80 | 13,55 | 7,80 | AFD 56-08-**-P/S-* A 5563 |
| AFD 56-10-**-P/S-* A 315 | 18,60 | 9,20 | 46,80 | 15,40 | 7,80 | AFD 56-10-**-P/S-* A 5563 |
| AFD 56-12-**-P/S-* A 315 | 21,75 | 12,65 | 46,80 | 19,70 | 7,80 | AFD 56-12-**-P/S-* A 5563 |
| AFD 56-14-**-P/S-* A 315 | 24,95 | 14,50 | 46,80 | 21,30 | 7,80 | AFD 56-14-**-P/S-* A 5563 |
| AFD 56-16-**-P/S-* A 315 | 28,20 | 17,70 | 46,80 | 24,50 | 7,80 | AFD 56-16-**-P/S-* A 5563 |
| AFD 56-18-**-P/S-* A 315 | 30,90 | 19,70 | 46,80 | 26,50 | 7,80 | AFD 56-18-**-P/S-* A 5563 |
| AFD 56-20-**-P/S-* A 315 | 34,15 | 22,90 | 49,10 | 30,95 | 10,08 | AFD 56-20-**-P/S-* A 5563 |
| AFD 56-22-**-P/S-* A 315 | 37,25 | 26,05 | 49,75 | 34,45 | 10,65 | AFD 56-22-**-P/S-* A 5563 |
| AFD 56-24-**-P/S-* A 315 | 40,45 | 29,00 | 49,75 | 36,65 | 10,65 | AFD 56-24-**-P/S-* A 5563 |

• With grounding adaptor



| Nickel Plating Reference | G max. | J mini. | L max. | Olive Drab Cadmium Plating Reference |
|--------------------------|--------|---------|--------|--------------------------------------|
| AFD 56-08-**-P/S-* A 564 | 18,00 | 6,80 | 66,20 | AFD 56-08-**-P/S-* A 5534 |
| AFD 56-10-**-P/S-* A 564 | 20,10 | 9,30 | 66,00 | AFD 56-10-**-P/S-* A 5534 |
| AFD 56-12-**-P/S-* A 564 | 24,40 | 12,75 | 65,90 | AFD 56-12-**-P/S-* A 5534 |
| AFD 56-14-**-P/S-* A 564 | 27,50 | 14,65 | 66,10 | AFD 56-14-**-P/S-* A 5534 |
| AFD 56-16-**-P/S-* A 564 | 30,85 | 17,80 | 65,90 | AFD 56-16-**-P/S-* A 5534 |
| AFD 56-18-**-P/S-* A 564 | 33,90 | 19,80 | 65,20 | AFD 56-18-**-P/S-* A 5534 |
| AFD 56-20-**-P/S-* A 564 | 37,10 | 23,00 | 66,00 | AFD 56-20-**-P/S-* A 5534 |
| AFD 56-22-**-P/S-* A 564 | 40,20 | 26,15 | 66,10 | AFD 56-22-**-P/S-* A 5534 |
| AFD 56-24-**-P/S-* A 564 | 43,40 | 29,10 | 66,75 | AFD 56-24-**-P/S-* A 5534 |

Note : L dimension calculated for a braid of 1 m/m thickness

• With RFI fingers

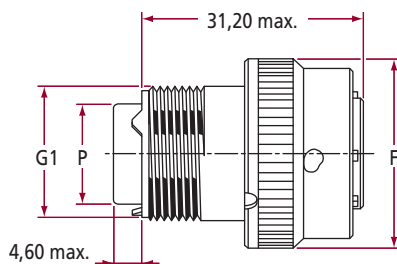
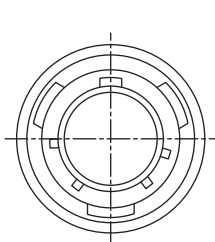

Without backshell
Nickel plating Mod. 1A
Olive drab cadmium plating Mod. A 5324



With backshell
Nickel plating without Mod.
Olive drab cadmium plating Mod. A 231

| Nickel Plating Reference | F max. | G max. | G1 max. | P max. | Olive Drab Cadmium Plating Reference |
|--------------------------|-----------|--------|---------|--------|--------------------------------------|
| AFD 57-08-**-P/S-* | 1 A 19,75 | 15,65 | 12,70 | 7,75 | AFD 57-08-**-P/S-* |
| AFD 57-10-**-P/S-* | 1 A 22,70 | 18,60 | 15,85 | 10,29 | AFD 57-10-**-P/S-* |
| AFD 57-12-**-P/S-* | 1 A 26,45 | 21,75 | 19,05 | 13,49 | AFD 57-12-**-P/S-* |
| AFD 57-14-**-P/S-* | 1 A 29,95 | 24,95 | 22,20 | 16,89 | AFD 57-14-**-P/S-* |
| AFD 57-16-**-P/S-* | 1 A 32,95 | 28,20 | 25,40 | 20,07 | AFD 57-16-**-P/S-* |
| AFD 57-18-**-P/S-* | 1 A 35,30 | 30,90 | 26,95 | 22,07 | AFD 57-18-**-P/S-* |
| AFD 57-20-**-P/S-* | 1 A 38,85 | 34,15 | 30,15 | 25,25 | AFD 57-20-**-P/S-* |
| AFD 57-22-**-P/S-* | 1 A 42,05 | 37,25 | 33,30 | 28,42 | AFD 57-22-**-P/S-* |
| AFD 57-24-**-P/S-* | 1 A 45,05 | 40,45 | 36,50 | 31,60 | AFD 57-24-**-P/S-* |

• With straight cable clamp



| Nickel Plating Reference | G max. | J mini. | J1 max. | L max. | Olive Drab Cadmium Plating Reference |
|--------------------------|--------|---------|---------|--------|--------------------------------------|
| AFD 57-08-**-P/S-* 059 | 15,65 | 6,80 | 5,15 | 46,10 | AFD 57-08-**-P/S-* A 5347 |
| AFD 57-10-**-P/S-* 059 | 18,60 | 9,30 | 7,25 | 46,10 | AFD 57-10-**-P/S-* A 5347 |
| AFD 57-12-**-P/S-* 059 | 21,75 | 12,75 | 10,55 | 46,10 | AFD 57-12-**-P/S-* A 5347 |
| AFD 57-14-**-P/S-* 059 | 24,95 | 14,65 | 12,05 | 52,10 | AFD 57-14-**-P/S-* A 5347 |
| AFD 57-16-**-P/S-* 059 | 28,20 | 17,80 | 15,85 | 52,10 | AFD 57-16-**-P/S-* A 5347 |
| AFD 57-18-**-P/S-* 059 | 30,90 | 19,80 | 17,90 | 52,10 | AFD 57-18-**-P/S-* A 5347 |
| AFD 57-20-**-P/S-* 059 | 34,15 | 23,00 | 21,05 | 52,10 | AFD 57-20-**-P/S-* A 5347 |
| AFD 57-22-**-P/S-* 059 | 37,25 | 26,15 | 24,25 | 52,10 | AFD 57-22-**-P/S-* A 5347 |
| AFD 57-24-**-P/S-* 059 | 40,45 | 29,10 | 27,45 | 52,10 | AFD 57-24-**-P/S-* A 5347 |

• With 90° end bell cable clamp



| Nickel Plating Reference | G max. | J mini. | J1 max. | L max. | T max. | Olive Drab Cadmium Plating Reference |
|--------------------------|--------|---------|---------|--------|--------|--------------------------------------|
| AFD 57-08-**-P/S-* 081 | 15,65 | 6,80 | 5,15 | 49,55 | 20,70 | AFD 57-08-**-P/S-* A 5543 |
| AFD 57-10-**-P/S-* 081 | 18,60 | 9,30 | 7,25 | 51,90 | 22,00 | AFD 57-10-**-P/S-* A 5543 |
| AFD 57-12-**-P/S-* 081 | 21,75 | 12,75 | 10,55 | 55,35 | 23,80 | AFD 57-12-**-P/S-* A 5543 |
| AFD 57-14-**-P/S-* 081 | 24,95 | 14,65 | 12,05 | 57,60 | 25,30 | AFD 57-14-**-P/S-* A 5543 |
| AFD 57-16-**-P/S-* 081 | 28,20 | 17,80 | 15,85 | 61,00 | 26,80 | AFD 57-16-**-P/S-* A 5543 |
| AFD 57-18-**-P/S-* 081 | 30,90 | 19,80 | 17,90 | 64,45 | 28,30 | AFD 57-18-**-P/S-* A 5543 |
| AFD 57-20-**-P/S-* 081 | 34,15 | 23,00 | 21,05 | 67,80 | 29,90 | AFD 57-20-**-P/S-* A 5543 |
| AFD 57-22-**-P/S-* 081 | 37,25 | 26,15 | 24,25 | 70,90 | 31,60 | AFD 57-22-**-P/S-* A 5543 |
| AFD 57-24-**-P/S-* 081 | 40,45 | 29,10 | 27,45 | 74,00 | 33,20 | AFD 57-24-**-P/S-* A 5543 |

• With potting cup



| Nickel Plating Reference | G max. | J mini. | L max. | Olive Drab Cadmium Plating Reference |
|--------------------------|--------|---------|--------|--------------------------------------|
| AFD 57-08-**-P/S-* 083 | 15,65 | 4,60 | 45,45 | AFD 57-08-**-P/S-* A 5629 |
| AFD 57-10-**-P/S-* 083 | 18,60 | 6,60 | 45,45 | AFD 57-10-**-P/S-* A 5629 |
| AFD 57-12-**-P/S-* 083 | 21,75 | 10,00 | 45,45 | AFD 57-12-**-P/S-* A 5629 |
| AFD 57-14-**-P/S-* 083 | 24,95 | 11,50 | 50,95 | AFD 57-14-**-P/S-* A 5629 |
| AFD 57-16-**-P/S-* 083 | 28,20 | 15,30 | 50,95 | AFD 57-16-**-P/S-* A 5629 |
| AFD 57-18-**-P/S-* 083 | 30,90 | 17,30 | 50,95 | AFD 57-18-**-P/S-* A 5629 |
| AFD 57-20-**-P/S-* 083 | 34,15 | 20,50 | 50,95 | AFD 57-20-**-P/S-* A 5629 |
| AFD 57-22-**-P/S-* 083 | 37,25 | 23,70 | 50,95 | AFD 57-22-**-P/S-* A 5629 |
| AFD 57-24-**-P/S-* 083 | 40,45 | 26,80 | 50,95 | AFD 57-24-**-P/S-* A 5629 |

• Fitting for thermo-shrink sleeve



| Nickel Plating Reference | G max. | J max. | L max. | P max. | S max. | Olive Drab Cadmium Plating Reference |
|--------------------------|--------|--------|--------|--------|--------|--------------------------------------|
| AFD 57-08-**-P/S-* A 315 | 15,65 | 6,50 | 46,80 | 13,55 | 7,80 | AFD 57-08-**-P/S-* A 5563 |
| AFD 57-10-**-P/S-* A 315 | 18,60 | 9,20 | 46,80 | 15,40 | 7,80 | AFD 57-10-**-P/S-* A 5563 |
| AFD 57-12-**-P/S-* A 315 | 21,75 | 12,65 | 46,80 | 19,70 | 7,80 | AFD 57-12-**-P/S-* A 5563 |
| AFD 57-14-**-P/S-* A 315 | 24,95 | 14,50 | 46,80 | 21,30 | 7,80 | AFD 57-14-**-P/S-* A 5563 |
| AFD 57-16-**-P/S-* A 315 | 28,20 | 17,70 | 46,80 | 24,50 | 7,80 | AFD 57-16-**-P/S-* A 5563 |
| AFD 57-18-**-P/S-* A 315 | 30,90 | 19,70 | 46,80 | 26,50 | 7,80 | AFD 57-18-**-P/S-* A 5563 |
| AFD 57-20-**-P/S-* A 315 | 34,15 | 22,90 | 49,10 | 30,95 | 10,08 | AFD 57-20-**-P/S-* A 5563 |
| AFD 57-22-**-P/S-* A 315 | 37,25 | 26,05 | 49,75 | 34,45 | 10,65 | AFD 57-22-**-P/S-* A 5563 |
| AFD 57-24-**-P/S-* A 315 | 40,45 | 29,00 | 49,75 | 36,65 | 10,65 | AFD 57-24-**-P/S-* A 5563 |

• With grounding adaptor



| Nickel Plating Reference | G max. | J mini. | L max. | Olive Drab Cadmium Plating Reference |
|--------------------------|--------|---------|--------|--------------------------------------|
| AFD 57-08-**-P/S-* A 564 | 18,00 | 6,80 | 66,20 | AFD 57-08-**-P/S-* A 5534 |
| AFD 57-10-**-P/S-* A 564 | 20,10 | 9,30 | 66,00 | AFD 57-10-**-P/S-* A 5534 |
| AFD 57-12-**-P/S-* A 564 | 24,40 | 12,75 | 65,90 | AFD 57-12-**-P/S-* A 5534 |
| AFD 57-14-**-P/S-* A 564 | 27,50 | 14,65 | 66,10 | AFD 57-14-**-P/S-* A 5534 |
| AFD 57-16-**-P/S-* A 564 | 30,85 | 17,80 | 65,90 | AFD 57-16-**-P/S-* A 5534 |
| AFD 57-18-**-P/S-* A 564 | 33,90 | 19,80 | 65,20 | AFD 57-18-**-P/S-* A 5534 |
| AFD 57-20-**-P/S-* A 564 | 37,10 | 23,00 | 66,00 | AFD 57-20-**-P/S-* A 5534 |
| AFD 57-22-**-P/S-* A 564 | 40,20 | 26,15 | 66,10 | AFD 57-22-**-P/S-* A 5534 |
| AFD 57-24-**-P/S-* A 564 | 43,40 | 29,10 | 66,75 | AFD 57-24-**-P/S-* A 5534 |

Note : L dimension calculated for a braid of 1 m/m thickness

Large square flange receptacle

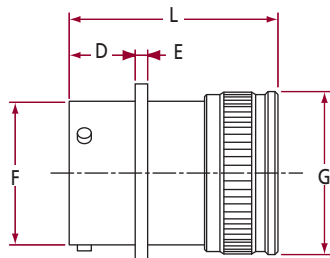

With backshell

Nickel plating without Mod.
Olive drab cadmium plating Mod. A 231

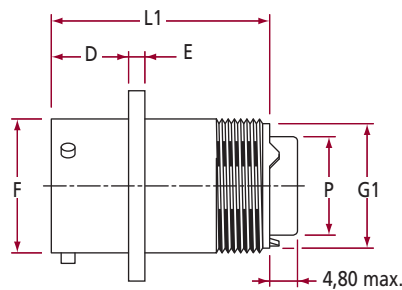

Without backshell

Nickel plating Mod. 1A
Olive drab cadmium plating Mod. A 5324

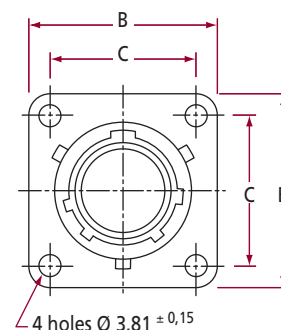

4 holes $\varnothing 3,81 \pm 0,15$

| Nickel Plating Reference | B max. | C $\pm 0,1$ | D $\pm 0,15$ | E max. | F max. | G max. | G1 max. | L max. | L1 max. | P max. | Olive Drab Cadmium Plating Reference |
|--------------------------|-----------|-------------|--------------|--------|--------|--------|---------|--------|---------|--------|--------------------------------------|
| AFD 58-08-**-P/S-* | 1 A 27,05 | 18,64 | 11,89 | 1,95 | 12,03 | 15,65 | 12,70 | 36,85 | 30,85 | 7,75 | AFD 58-08-**-P/S-* |
| AFD 58-10-**-P/S-* | 1 A 28,95 | 20,62 | 11,89 | 1,95 | 15,01 | 18,60 | 15,85 | 36,85 | 30,85 | 10,29 | AFD 58-10-**-P/S-* |
| AFD 58-12-**-P/S-* | 1 A 32,15 | 23,82 | 11,89 | 1,95 | 19,07 | 21,75 | 19,05 | 36,85 | 30,85 | 13,49 | AFD 58-12-**-P/S-* |
| AFD 58-14-**-P/S-* | 1 A 34,50 | 26,22 | 11,89 | 1,95 | 22,24 | 24,95 | 22,20 | 36,85 | 30,85 | 16,89 | AFD 58-14-**-P/S-* |
| AFD 58-16-**-P/S-* | 1 A 36,90 | 28,56 | 11,89 | 1,95 | 25,42 | 28,20 | 25,40 | 36,85 | 30,85 | 20,07 | AFD 58-16-**-P/S-* |
| AFD 58-18-**-P/S-* | 1 A 38,90 | 30,58 | 11,89 | 1,95 | 28,60 | 30,90 | 26,95 | 36,85 | 30,85 | 22,07 | AFD 58-18-**-P/S-* |
| AFD 58-20-**-P/S-* | 1 A 42,85 | 32,96 | 14,30 | 2,55 | 31,77 | 34,15 | 30,15 | 38,40 | 32,35 | 25,25 | AFD 58-20-**-P/S-* |
| AFD 58-22-**-P/S-* | 1 A 44,85 | 34,96 | 14,30 | 2,55 | 34,94 | 37,25 | 33,30 | 38,40 | 32,35 | 28,42 | AFD 58-22-**-P/S-* |
| AFD 58-24-**-P/S-* | 1 A 48,00 | 38,10 | 15,37 | 2,55 | 38,12 | 40,45 | 36,50 | 38,40 | 32,35 | 31,60 | AFD 58-24-**-P/S-* |

Mounting styles

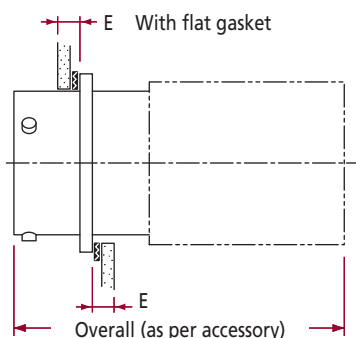

Overall (as per accessory)

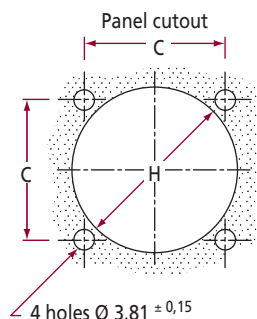

4 holes $\varnothing 3,81 \pm 0,15$

| Size | C $\pm 0,1$ | H $+0 -0,2$ | E max. |
|------|-------------|-------------|--------|
| 08 | 18,64 | 16,05 | 2,50 |
| 10 | 20,62 | 19,00 | 2,50 |
| 12 | 23,82 | 22,25 | 2,50 |
| 14 | 26,22 | 25,40 | 2,50 |
| 16 | 28,56 | 28,60 | 2,50 |
| 18 | 30,58 | 31,75 | 2,50 |
| 20 | 32,96 | 34,90 | 5,40 |
| 22 | 34,96 | 38,10 | 5,40 |
| 24 | 38,10 | 41,30 | 5,40 |

Flat gasket for square flange receptacle

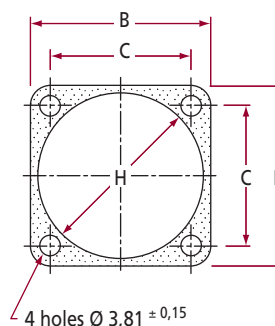
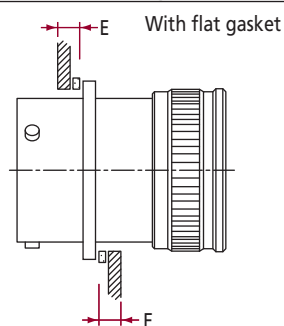

4 holes $\varnothing 3,81 \pm 0,15$

| Front Flange Mounting | | | | | Rear Flange Mounting | | | |
|-----------------------|-------------------|--------|--------|-------------|----------------------|--------|-------------------|------|
| Size | Reference | H max. | B max. | C $\pm 0,1$ | E max. | H max. | Reference | Size |
| 08 | 108-0003-08-A 624 | 12,50 | 21,00 | 15,08 | 2,50 | 13,20 | 108-0001-08-A 624 | 08 |
| 10 | 108-0003-10-A 624 | 15,40 | 24,20 | 18,26 | 2,50 | 16,40 | 108-0001-10-A 624 | 10 |
| 12 | 108-0001-12-A 624 | 19,50 | 26,55 | 20,62 | 2,50 | 19,50 | 108-0001-12-A 624 | 12 |
| 14 | 108-0001-14-A 624 | 22,70 | 28,95 | 23,02 | 2,50 | 22,70 | 108-0001-14-A 624 | 14 |
| 16 | 108-0001-16-A 624 | 25,90 | 31,30 | 24,58 | 2,50 | 25,90 | 108-0001-16-A 624 | 16 |
| 18 | 108-0003-18-A 624 | 29,10 | 33,70 | 26,98 | 2,50 | 27,50 | 108-0001-18-A 624 | 18 |
| 20 | 108-0003-20-A 624 | 32,30 | 36,85 | 29,36 | 5,40 | 30,60 | 108-0001-20-A 624 | 20 |
| 22 | 108-0003-22-A 624 | 35,40 | 39,95 | 31,75 | 5,40 | 33,50 | 108-0001-22-A 624 | 22 |
| 24 | 108-0003-24-A 624 | 38,60 | 43,15 | 34,92 | 5,40 | 37,00 | 108-0001-24-A 624 | 24 |

A 624 = Flat gasket resistant to oronite

Large square flange

With straight cable clamp

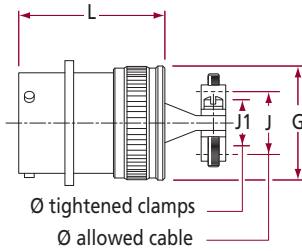

| Nickel Plating Reference | G max. | J mini. | J1 max. | L max. | Olive Drab Cadmium Plating Reference |
|--------------------------|--------|---------|---------|--------|--------------------------------------|
| AFD 58-08-**-P/S-* 059 | 15,65 | 6,80 | 5,15 | 45,85 | AFD 58-08-**-P/S-* A 5347 |
| AFD 58-10-**-P/S-* 059 | 18,60 | 9,30 | 7,25 | 45,85 | AFD 58-10-**-P/S-* A 5347 |
| AFD 58-12-**-P/S-* 059 | 21,75 | 12,75 | 10,55 | 45,85 | AFD 58-12-**-P/S-* A 5347 |
| AFD 58-14-**-P/S-* 059 | 24,95 | 14,65 | 12,05 | 51,85 | AFD 58-14-**-P/S-* A 5347 |
| AFD 58-16-**-P/S-* 059 | 28,20 | 17,80 | 15,85 | 51,85 | AFD 58-16-**-P/S-* A 5347 |
| AFD 58-18-**-P/S-* 059 | 30,90 | 19,80 | 17,90 | 51,85 | AFD 58-18-**-P/S-* A 5347 |
| AFD 58-20-**-P/S-* 059 | 34,15 | 23,00 | 21,05 | 53,35 | AFD 58-20-**-P/S-* A 5347 |
| AFD 58-22-**-P/S-* 059 | 37,25 | 26,15 | 24,25 | 53,35 | AFD 58-22-**-P/S-* A 5347 |
| AFD 58-24-**-P/S-* 059 | 40,45 | 29,10 | 27,45 | 53,35 | AFD 58-24-**-P/S-* A 5347 |

With 90° end bell cable clamp

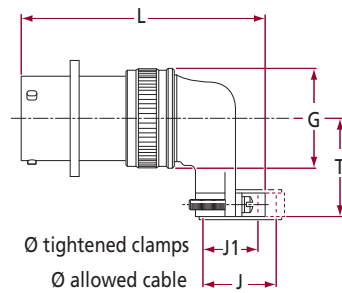

| Nickel Plating Reference | G max. | J mini. | J1 max. | L max. | T max. | Olive Drab Cadmium Plating Reference |
|--------------------------|--------|---------|---------|--------|--------|--------------------------------------|
| AFD 58-08-**-P/S-* 081 | 15,65 | 6,80 | 5,15 | 49,30 | 20,70 | AFD 58-08-**-P/S-* A 5543 |
| AFD 58-10-**-P/S-* 081 | 18,60 | 9,30 | 7,25 | 51,65 | 22,00 | AFD 58-10-**-P/S-* A 5543 |
| AFD 58-12-**-P/S-* 081 | 21,75 | 12,75 | 10,55 | 54,10 | 23,80 | AFD 58-12-**-P/S-* A 5543 |
| AFD 58-14-**-P/S-* 081 | 24,95 | 14,65 | 12,05 | 57,35 | 25,30 | AFD 58-14-**-P/S-* A 5543 |
| AFD 58-16-**-P/S-* 081 | 28,20 | 17,80 | 15,85 | 60,75 | 26,80 | AFD 58-16-**-P/S-* A 5543 |
| AFD 58-18-**-P/S-* 081 | 30,90 | 19,80 | 17,90 | 64,20 | 28,30 | AFD 58-18-**-P/S-* A 5543 |
| AFD 58-20-**-P/S-* 081 | 34,15 | 23,00 | 21,05 | 69,05 | 29,90 | AFD 58-20-**-P/S-* A 5543 |
| AFD 58-22-**-P/S-* 081 | 37,25 | 26,15 | 24,25 | 72,15 | 31,60 | AFD 58-22-**-P/S-* A 5543 |
| AFD 58-24-**-P/S-* 081 | 40,45 | 29,10 | 27,45 | 75,25 | 33,20 | AFD 58-24-**-P/S-* A 5543 |

With potting cup

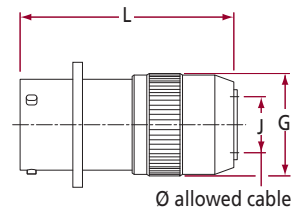

| Nickel Plating Reference | G max. | J mini. | L max. | Olive Drab Cadmium Plating Reference |
|--------------------------|--------|---------|--------|--------------------------------------|
| AFD 58-08-**-P/S-* 083 | 15,65 | 4,60 | 44,70 | AFD 58-08-**-P/S-* A 5629 |
| AFD 58-10-**-P/S-* 083 | 18,60 | 6,60 | 44,70 | AFD 58-10-**-P/S-* A 5629 |
| AFD 58-12-**-P/S-* 083 | 21,75 | 10,00 | 44,70 | AFD 58-12-**-P/S-* A 5629 |
| AFD 58-14-**-P/S-* 083 | 24,95 | 11,50 | 50,20 | AFD 58-14-**-P/S-* A 5629 |
| AFD 58-16-**-P/S-* 083 | 28,20 | 15,30 | 50,20 | AFD 58-16-**-P/S-* A 5629 |
| AFD 58-18-**-P/S-* 083 | 30,90 | 17,30 | 50,20 | AFD 58-18-**-P/S-* A 5629 |
| AFD 58-20-**-P/S-* 083 | 34,15 | 20,50 | 51,70 | AFD 58-20-**-P/S-* A 5629 |
| AFD 58-22-**-P/S-* 083 | 37,25 | 23,70 | 51,70 | AFD 58-22-**-P/S-* A 5629 |
| AFD 58-24-**-P/S-* 083 | 40,45 | 26,80 | 51,70 | AFD 58-24-**-P/S-* A 5629 |

Fitting for thermo-shrink sleeve

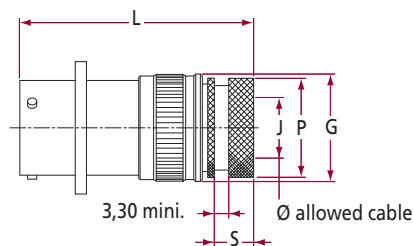

| Nickel Plating Reference | G max. | J mini. | L max. | P max. | S max. | Olive Drab Cadmium Plating Reference |
|--------------------------|--------|---------|--------|--------|--------|--------------------------------------|
| AFD 58-08-**-P/S-* A 315 | 15,65 | 6,50 | 46,55 | 13,55 | 7,80 | AFD 58-08-**-P/S-* A 5563 |
| AFD 58-10-**-P/S-* A 315 | 18,60 | 9,20 | 46,55 | 15,40 | 7,80 | AFD 58-10-**-P/S-* A 5563 |
| AFD 58-12-**-P/S-* A 315 | 21,75 | 12,65 | 46,55 | 19,70 | 7,80 | AFD 58-12-**-P/S-* A 5563 |
| AFD 58-14-**-P/S-* A 315 | 24,95 | 14,50 | 46,55 | 21,30 | 7,80 | AFD 58-14-**-P/S-* A 5563 |
| AFD 58-16-**-P/S-* A 315 | 28,20 | 17,70 | 46,55 | 24,50 | 7,80 | AFD 58-16-**-P/S-* A 5563 |
| AFD 58-18-**-P/S-* A 315 | 30,90 | 19,70 | 46,55 | 26,50 | 7,80 | AFD 58-18-**-P/S-* A 5563 |
| AFD 58-20-**-P/S-* A 315 | 34,15 | 22,90 | 50,35 | 30,95 | 10,08 | AFD 58-20-**-P/S-* A 5563 |
| AFD 58-22-**-P/S-* A 315 | 37,25 | 26,05 | 51,00 | 34,45 | 10,65 | AFD 58-22-**-P/S-* A 5563 |
| AFD 58-24-**-P/S-* A 315 | 40,45 | 29,00 | 51,00 | 36,65 | 10,65 | AFD 58-24-**-P/S-* A 5563 |

With grounding adaptor

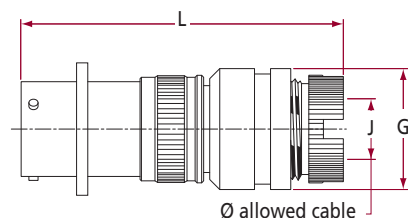

| Nickel Plating Reference | G max. | J mini. | L max. | Olive Drab Cadmium Plating Reference |
|--------------------------|--------|---------|--------|--------------------------------------|
| AFD 58-08-**-P/S-* A 564 | 18,00 | 6,80 | 65,90 | AFD 58-08-**-P/S-* A 5534 |
| AFD 58-10-**-P/S-* A 564 | 20,10 | 9,30 | 65,70 | AFD 58-10-**-P/S-* A 5534 |
| AFD 58-12-**-P/S-* A 564 | 24,40 | 12,75 | 65,60 | AFD 58-12-**-P/S-* A 5534 |
| AFD 58-14-**-P/S-* A 564 | 27,50 | 14,65 | 65,80 | AFD 58-14-**-P/S-* A 5534 |
| AFD 58-16-**-P/S-* A 564 | 30,85 | 17,80 | 65,60 | AFD 58-16-**-P/S-* A 5534 |
| AFD 58-18-**-P/S-* A 564 | 33,90 | 19,80 | 64,90 | AFD 58-18-**-P/S-* A 5534 |
| AFD 58-20-**-P/S-* A 564 | 37,10 | 23,00 | 67,25 | AFD 58-20-**-P/S-* A 5534 |
| AFD 58-22-**-P/S-* A 564 | 40,20 | 26,15 | 67,35 | AFD 58-22-**-P/S-* A 5534 |
| AFD 58-24-**-P/S-* A 564 | 43,40 | 29,10 | 68,00 | AFD 58-24-**-P/S-* A 5534 |

Note : L dimension calculated for a braid of 1 m/m thickness

With backshell



| Nickel Plating Reference | A max. | B max. | D ± 0,15 | E max. | F max. | G max. | L max. | Olive Drab Cadmium Plating Reference |
|--------------------------|--------|--------|----------|--------|--------|--------|--------|--------------------------------------|
| AFD 51-08-**-P/S-* | 24,15 | 21,00 | 11,13 | 1,95 | 12,03 | 15,65 | 36,85 | AFD 51-08-**-P/S-* A 231 |
| AFD 51-10-**-P/S-* | 27,30 | 24,20 | 11,13 | 1,95 | 15,01 | 18,60 | 36,85 | AFD 51-10-**-P/S-* A 231 |
| AFD 51-12-**-P/S-* | 29,70 | 26,55 | 11,13 | 1,95 | 19,07 | 21,75 | 36,85 | AFD 51-12-**-P/S-* A 231 |
| AFD 51-14-**-P/S-* | 32,05 | 28,95 | 11,13 | 1,95 | 22,24 | 24,95 | 36,85 | AFD 51-14-**-P/S-* A 231 |
| AFD 51-16-**-P/S-* | 34,45 | 31,30 | 11,13 | 1,95 | 25,42 | 28,20 | 36,85 | AFD 51-16-**-P/S-* A 231 |
| AFD 51-18-**-P/S-* | 36,85 | 33,70 | 11,13 | 1,95 | 28,60 | 30,90 | 36,85 | AFD 51-18-**-P/S-* A 231 |
| AFD 51-20-**-P/S-* | 40,00 | 36,85 | 14,30 | 2,55 | 31,77 | 34,15 | 38,40 | AFD 51-20-**-P/S-* A 231 |
| AFD 51-22-**-P/S-* | 43,20 | 39,95 | 14,30 | 2,55 | 34,94 | 37,25 | 38,40 | AFD 51-22-**-P/S-* A 231 |
| AFD 51-24-**-P/S-* | 46,30 | 43,15 | 15,10 | 2,55 | 38,12 | 40,45 | 38,40 | AFD 51-24-**-P/S-* A 231 |

With straight cable clamp



| Nickel Plating Reference | A max. | B max. | D ± 0,15 | E max. | F max. | G max. | J mini. | J1 max. | L max. | Olive Drab Cadmium Plating Reference |
|--------------------------|--------|--------|----------|--------|--------|--------|---------|---------|--------|--------------------------------------|
| AFD 51-08-**-P/S*-059 | 24,15 | 21,00 | 11,13 | 1,95 | 12,03 | 15,65 | 6,80 | 5,15 | 45,85 | AFD 51-08-**-P/S*-A 5347 |
| AFD 51-10-**-P/S*-059 | 27,30 | 24,20 | 11,13 | 1,95 | 15,01 | 18,60 | 9,30 | 7,25 | 45,85 | AFD 51-10-**-P/S*-A 5347 |
| AFD 51-12-**-P/S*-059 | 29,70 | 26,55 | 11,13 | 1,95 | 19,07 | 21,75 | 12,75 | 10,55 | 45,85 | AFD 51-12-**-P/S*-A 5347 |
| AFD 51-14-**-P/S*-059 | 32,05 | 28,95 | 11,13 | 1,95 | 22,24 | 24,95 | 14,65 | 12,05 | 51,85 | AFD 51-14-**-P/S*-A 5347 |
| AFD 51-16-**-P/S*-059 | 34,45 | 31,30 | 11,13 | 1,95 | 25,42 | 28,20 | 17,80 | 15,85 | 51,85 | AFD 51-16-**-P/S*-A 5347 |
| AFD 51-18-**-P/S*-059 | 36,85 | 33,70 | 11,13 | 1,95 | 28,60 | 30,90 | 19,80 | 17,90 | 51,85 | AFD 51-18-**-P/S*-A 5347 |
| AFD 51-20-**-P/S*-059 | 40,00 | 36,85 | 14,30 | 2,55 | 31,77 | 34,15 | 23,00 | 21,05 | 53,35 | AFD 51-20-**-P/S*-A 5347 |
| AFD 51-22-**-P/S*-059 | 43,20 | 39,95 | 14,30 | 2,55 | 34,94 | 37,25 | 26,15 | 24,25 | 53,35 | AFD 51-22-**-P/S*-A 5347 |
| AFD 51-24-**-P/S*-059 | 46,30 | 43,15 | 15,10 | 2,55 | 38,12 | 40,45 | 29,10 | 27,45 | 53,35 | AFD 51-24-**-P/S*-A 5347 |

AFD 56 / AFD 50



| Size | E max. | K max. | L max. | L' max. | L1 max. | L1' max. |
|----------|-----------|-----------|-----------|------------|------------|-------------|
| 08 to 18 | 2,50 | 23,85 | 48,10 | 50,10 | 38,70 | 40,70 |
| 20 to 22 | 5,40 | 21,45 | 52,60 | 55,15 | 43,30 | 45,85 |
| 24 | 5,40 | 20,65 | 53,40 | 55,95 | 44,10 | 46,65 |

AFD 56 / AFD 54



| Size | E max. | K max. | L max. | L1 max. |
|----------|-----------|-----------|-----------|------------|
| 08 to 18 | 4,30 | 16,30 | 54,75 | 45,45 |
| 20 to 24 | 6,35 | 15,35 | 56,40 | 47,10 |

Backshell



| Size | Nickel Plating Reference | Olive Drab Cadmium Reference |
|------|--------------------------|------------------------------|
| 08 | 94002-08-3014 | 94002-08-A 231 |
| 10 | 94002-10-3014 | 94002-10-A 231 |
| 12 | 94002-12-3014 | 94002-12-A 231 |
| 14 | 94002-14-3014 | 94002-14-A 231 |
| 16 | 94002-16-3014 | 94002-16-A 231 |
| 18 | 94002-18-3014 | 94002-18-A 231 |
| 20 | 94002-20-3014 | 94002-20-A 231 |
| 22 | 94002-22-3014 | 94002-22-A 231 |
| 24 | 94002-24-3014 | 94002-24-A 231 |

Straight cable clamp



| Size | Nickel Plating Reference | Olive Drab Cadmium Reference |
|------|--------------------------|------------------------------|
| 08 | 94003-08-3014 | 94003-08-A 231 |
| 10 | 94003-10-3014 | 94003-10-A 231 |
| 12 | 94003-12-3014 | 94003-12-A 231 |
| 14 | 94003-14-3014 | 94003-14-A 231 |
| 16 | 94003-16-3014 | 94003-16-A 231 |
| 18 | 94003-18-3014 | 94003-18-A 231 |
| 20 | 94003-20-3014 | 94003-20-A 231 |
| 22 | 94003-22-3014 | 94003-22-A 231 |
| 24 | 94003-24-3014 | 94003-24-A 231 |

90° end bell cable clamp

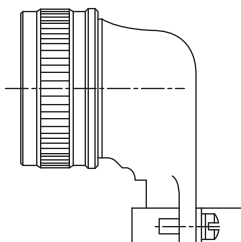

| Size | Nickel Plating Reference | Olive Drab Cadmium Reference |
|------|--------------------------|------------------------------|
| 08 | 94004-08-3014 | 94004-08-A 231 |
| 10 | 94004-10-3014 | 94004-10-A 231 |
| 12 | 94004-12-3014 | 94004-12-A 231 |
| 14 | 94004-14-3014 | 94004-14-A 231 |
| 16 | 94004-16-3014 | 94004-16-A 231 |
| 18 | 94004-18-3014 | 94004-18-A 231 |
| 20 | 94004-20-3014 | 94004-20-A 231 |
| 22 | 94004-22-3014 | 94004-22-A 231 |
| 24 | 94004-24-3014 | 94004-24-A 231 |

Potting cup

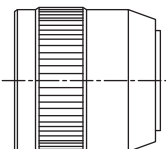

| Size | Nickel Plating Reference | Olive Drab Cadmium Reference |
|------|--------------------------|------------------------------|
| 08 | 006-0701-08-A 499 | 006-0701-08-A 231 |
| 10 | 006-0701-10-A 499 | 006-0701-10-A 231 |
| 12 | 006-0701-12-A 499 | 006-0701-12-A 231 |
| 14 | 006-0701-14-A 499 | 006-0701-14-A 231 |
| 16 | 006-0701-16-A 499 | 006-0701-16-A 231 |
| 18 | 006-0701-18-A 499 | 006-0701-18-A 231 |
| 20 | 006-0701-20-A 499 | 006-0701-20-A 231 |
| 22 | 006-0701-22-A 499 | 006-0701-22-A 231 |
| 24 | 006-0701-24-A 499 | 006-0701-24-A 231 |

Thermo-shrink sleeve



| Size | Nickel Plating Reference | Olive Drab Cadmium Reference |
|------|--------------------------|------------------------------|
| 08 | 004-0062-08-A 499 | 004-0062-08-A 231 |
| 10 | 004-0062-10-A 499 | 004-0062-10-A 231 |
| 12 | 004-0062-12-A 499 | 004-0062-12-A 231 |
| 14 | 004-0062-14-A 499 | 004-0062-14-A 231 |
| 16 | 004-0062-16-A 499 | 004-0062-16-A 231 |
| 18 | 004-0062-18-A 499 | 004-0062-18-A 231 |
| 20 | 004-0062-20-A 499 | 004-0062-20-A 231 |
| 22 | 004-0062-22-A 499 | 004-0062-22-A 231 |
| 24 | 004-0062-24-A 499 | 004-0062-24-A 231 |

Grounding adaptor



| Size | Nickel Plating Reference | Olive Drab Cadmium Reference |
|------|--------------------------|------------------------------|
| 08 | 014-1048-08-A 499 | 014-1048-08-A 231 |
| 10 | 014-1048-10-A 499 | 014-1048-10-A 231 |
| 12 | 014-1048-12-A 499 | 014-1048-12-A 231 |
| 14 | 014-1048-14-A 499 | 014-1048-14-A 231 |
| 16 | 014-1048-16-A 499 | 014-1048-16-A 231 |
| 18 | 014-1048-18-A 499 | 014-1048-18-A 231 |
| 20 | 014-1048-20-A 499 | 014-1048-20-A 231 |
| 22 | 014-1048-22-A 499 | 014-1048-22-A 231 |
| 24 | 014-1048-24-A 499 | 014-1048-24-A 231 |

Dummy receptacle for plugs

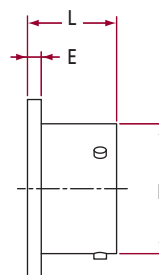

| Nickel Plating Reference | B max. | C $\pm 0,1$ | E max. | F max. | L max. | Olive Drab Cadmium Plating Reference |
|--------------------------|--------|-------------|--------|--------|--------|--------------------------------------|
| AFD 50-PR-08 | 21,00 | 15,08 | 1,95 | 12,03 | 14,70 | AFD 50-PR-08-A 231 |
| AFD 50-PR-10 | 24,20 | 18,26 | 1,95 | 15,01 | 14,70 | AFD 50-PR-10-A 231 |
| AFD 50-PR-12 | 26,55 | 20,62 | 1,95 | 19,07 | 14,70 | AFD 50-PR-12-A 231 |
| AFD 50-PR-14 | 28,95 | 23,02 | 1,95 | 22,24 | 14,70 | AFD 50-PR-14-A 231 |
| AFD 50-PR-16 | 31,30 | 24,58 | 1,95 | 25,42 | 14,70 | AFD 50-PR-16-A 231 |
| AFD 50-PR-18 | 33,70 | 26,98 | 1,95 | 28,60 | 14,70 | AFD 50-PR-18-A 231 |
| AFD 50-PR-20 | 36,85 | 29,36 | 2,55 | 31,77 | 17,20 | AFD 50-PR-20-A 231 |
| AFD 50-PR-22 | 39,95 | 31,76 | 2,55 | 34,94 | 17,20 | AFD 50-PR-22-A 231 |
| AFD 50-PR-24 | 43,15 | 34,92 | 2,55 | 38,12 | 17,20 | AFD 50-PR-24-A 231 |

■ For receptacle mounting on square flange receptacle



| Nickel Plating Reference | | F | L | L1 | L2 | P | Olive Drab Cadmium Reference | |
|--------------------------|-----------------|-------|-------|--------|--------|-------|------------------------------|-------------------|
| Nylon braid | Stainless chain | max. | max. | ± 5 | max. | max. | Nylon braid | Stainless chain |
| AFD B 50-08 | AFD C 50-08 | 16,60 | 17,85 | 130,00 | 79,00 | 14,20 | AFD B 50-08- A 231 | AFD C 50-08-A 231 |
| AFD B 50-10 | AFD C 50-10 | 19,70 | 17,85 | 130,00 | 79,00 | 14,20 | AFD B 50-10- A 231 | AFD C 50-10-A 231 |
| AFD B 50-12 | AFD C 50-12 | 24,60 | 17,85 | 130,00 | 95,00 | 14,20 | AFD B 50-12- A 231 | AFD C 50-12-A 231 |
| AFD B 50-14 | AFD C 50-14 | 27,80 | 17,85 | 130,00 | 95,00 | 14,20 | AFD B 50-14- A 231 | AFD C 50-14-A 231 |
| AFD B 50-16 | AFD C 50-16 | 30,90 | 17,85 | 142,00 | 95,00 | 14,20 | AFD B 50-16- A 231 | AFD C 50-16-A 231 |
| AFD B 50-18 | AFD C 50-18 | 34,10 | 17,85 | 142,00 | 95,00 | 14,20 | AFD B 50-18- A 231 | AFD C 50-18-A 231 |
| AFD B 50-20 | AFD C 50-20 | 37,30 | 17,85 | 142,00 | 111,00 | 14,20 | AFD B 50-20- A 231 | AFD C 50-20-A 231 |
| AFD B 50-22 | AFD C 50-22 | 40,50 | 17,85 | 142,00 | 111,00 | 14,20 | AFD B 50-22- A 231 | AFD C 50-22-A 231 |
| AFD B 50-24 | AFD C 50-24 | 44,10 | 18,85 | 142,00 | 111,00 | 15,20 | AFD B 50-24- A 231 | AFD C 50-24-A 231 |

■ For receptacle mounting on single hole mounting



| Nickel Plating Reference | | F | G | L | L1 | L2 | P | Olive Drab Cadmium Reference | |
|--------------------------|-----------------|-------|-------|-------|--------|--------|-------|------------------------------|----------------------|
| Nylon braid | Stainless chain | max. | mini. | max. | ± 5 | max. | max. | Nylon braid | Stainless chain |
| AFD B 50-54-08 | AFD C 50-54-08 | 16,60 | 14,60 | 17,85 | 130,00 | 79,00 | 14,20 | AFD B 50-54-08- A 231 | AFD C 50-54-08-A 231 |
| AFD B 50-54-10 | AFD C 50-54-10 | 19,70 | 17,70 | 17,85 | 130,00 | 79,00 | 14,20 | AFD B 50-54-10- A 231 | AFD C 50-54-10-A 231 |
| AFD B 50-54-12 | AFD C 50-54-12 | 24,60 | 22,50 | 17,85 | 130,00 | 95,00 | 14,20 | AFD B 50-54-12- A 231 | AFD C 50-54-12-A 231 |
| AFD B 50-54-14 | AFD C 50-54-14 | 27,80 | 25,70 | 17,85 | 130,00 | 95,00 | 14,20 | AFD B 50-54-14- A 231 | AFD C 50-54-14-A 231 |
| AFD B 50-54-16 | AFD C 50-54-16 | 30,90 | 28,90 | 17,85 | 142,00 | 95,00 | 14,20 | AFD B 50-54-16- A 231 | AFD C 50-54-16-A 231 |
| AFD B 50-54-18 | AFD C 50-54-18 | 34,10 | 32,00 | 17,85 | 142,00 | 95,00 | 14,20 | AFD B 50-54-18- A 231 | AFD C 50-54-18-A 231 |
| AFD B 50-54-20 | AFD C 50-54-20 | 37,30 | 35,20 | 17,85 | 142,00 | 111,00 | 14,20 | AFD B 50-54-20- A 231 | AFD C 50-54-20-A 231 |
| AFD B 50-54-22 | AFD C 50-54-22 | 40,50 | 38,40 | 17,85 | 142,00 | 111,00 | 14,20 | AFD B 50-54-22- A 231 | AFD C 50-54-22-A 231 |
| AFD B 50-54-24 | AFD C 50-54-24 | 44,10 | 41,60 | 18,85 | 142,00 | 111,00 | 15,20 | AFD B 50-54-24- A 231 | AFD C 50-54-24-A 231 |

For plug attached to cable clamp



| Nickel Plating Reference | | A | B | F | L | L1 | L2 | P | Olive Drab Cadmium Reference | |
|--------------------------|-----------------|-------|-------|-------|-------|--------|--------|-------|------------------------------|-------------------|
| Nylon braid | Stainless chain | max. | max. | max. | max. | ± 5 | max. | max. | Nylon braid | Stainless chain |
| AFD B 56-08 | AFD C 56-08 | 18,30 | 16,10 | 12,03 | 18,65 | 130,00 | 95,00 | 14,40 | AFD B 56-08-A 231 | AFD C 56-08-A 231 |
| AFD B 56-10 | AFD C 56-10 | 21,50 | 18,10 | 15,01 | 18,65 | 130,00 | 95,00 | 14,40 | AFD B 56-10-A 231 | AFD C 56-10-A 231 |
| AFD B 56-12 | AFD C 56-12 | 25,40 | 22,10 | 19,07 | 18,65 | 130,00 | 111,00 | 14,40 | AFD B 56-12-A 231 | AFD C 56-12-A 231 |
| AFD B 56-14 | AFD C 56-14 | 28,60 | 24,10 | 22,24 | 18,65 | 130,00 | 111,00 | 14,40 | AFD B 56-14-A 231 | AFD C 56-14-A 231 |
| AFD B 56-16 | AFD C 56-16 | 31,80 | 27,10 | 25,42 | 18,65 | 142,00 | 111,00 | 14,40 | AFD B 56-16-A 231 | AFD C 56-16-A 231 |
| AFD B 56-18 | AFD C 56-18 | 34,90 | 30,10 | 28,60 | 18,65 | 142,00 | 111,00 | 14,40 | AFD B 56-18-A 231 | AFD C 56-18-A 231 |
| AFD B 56-20 | AFD C 56-20 | 38,10 | 33,10 | 31,77 | 20,25 | 142,00 | 127,00 | 16,00 | AFD B 56-20-A 231 | AFD C 56-20-A 231 |
| AFD B 56-22 | AFD C 56-22 | 41,30 | 36,10 | 34,94 | 20,25 | 142,00 | 127,00 | 16,00 | AFD B 56-22-A 231 | AFD C 56-22-A 231 |
| AFD B 56-24 | AFD C 56-24 | 44,50 | 41,10 | 38,12 | 21,10 | 142,00 | 127,00 | 16,80 | AFD B 56-24-A 231 | AFD C 56-24-A 231 |

For plug attached for plug



| Nickel Plating Reference | | A | B | F | G | L | L1 | L2 | P | Olive Drab Cadmium Reference | |
|--------------------------|-----------------|-------|-------|-------|-------|-------|--------|--------|-------|------------------------------|----------------------|
| Nylon braid | Stainless chain | max. | max. | max. | mini. | max. | ± 5 | max. | max. | Nylon braid | Stainless chain |
| AFD B 56-56-08 | AFD C 56-56-08 | 18,30 | 16,10 | 12,03 | 12,45 | 18,65 | 130,00 | 79,00 | 14,40 | AFD B 56-56-08-A 231 | AFD C 56-56-08-A 231 |
| AFD B 56-56-10 | AFD C 56-56-10 | 21,50 | 18,10 | 15,01 | 15,70 | 18,65 | 130,00 | 79,00 | 14,40 | AFD B 56-56-10-A 231 | AFD C 56-56-10-A 231 |
| AFD B 56-56-12 | AFD C 56-56-12 | 25,40 | 22,10 | 19,07 | 18,85 | 18,65 | 130,00 | 95,00 | 14,40 | AFD B 56-56-12-A 231 | AFD C 56-56-12-A 231 |
| AFD B 56-56-14 | AFD C 56-56-14 | 28,60 | 24,10 | 22,24 | 22,10 | 18,65 | 130,00 | 95,00 | 14,40 | AFD B 56-56-14-A 231 | AFD C 56-56-14-A 231 |
| AFD B 56-56-16 | AFD C 56-56-16 | 31,80 | 27,10 | 25,42 | 25,50 | 18,65 | 142,00 | 95,00 | 14,40 | AFD B 56-56-16-A 231 | AFD C 56-56-16-A 231 |
| AFD B 56-56-18 | AFD C 56-56-18 | 34,90 | 30,10 | 28,60 | 27,35 | 18,65 | 142,00 | 95,00 | 14,40 | AFD B 56-56-18-A 231 | AFD C 56-56-18-A 231 |
| AFD B 56-56-20 | AFD C 56-56-20 | 38,10 | 33,10 | 31,77 | 30,40 | 20,25 | 142,00 | 111,00 | 16,00 | AFD B 56-56-20-A 231 | AFD C 56-56-20-A 231 |
| AFD B 56-56-22 | AFD C 56-56-22 | 41,30 | 36,10 | 34,94 | 33,30 | 20,25 | 142,00 | 111,00 | 16,00 | AFD B 56-56-22-A 231 | AFD C 56-56-22-A 231 |
| AFD B 56-56-24 | AFD C 56-56-24 | 44,50 | 41,10 | 38,12 | 36,80 | 21,10 | 142,00 | 111,00 | 16,80 | AFD B 56-56-24-A 231 | AFD C 56-56-24-A 231 |

Male contact



Female contact



Wire strip length



| CONTACTS | | | | | | | CABLES | | |
|----------------------------------|------------------|------|-------------|-------|-------------------------|-------------------|----------------------------|-------------|---------------|
| Commercial reference Codified | Former code | Type | AWG size | Index | Remarks | Color code 1 2 | Section in mm ² | AWG wire | Ø over sheath |
| 006-0937-20 A | 0641-10-2059 C | P | 20 | - | - | red red | 0,22 to 0,60 | 20 to 24 | 1,01 to 2,10 |
| 006-0912-20 A | 0603-34-2059 C | S | 20 | - | - | red red | 0,22 to 0,60 | 20 to 24 | 1,01 to 2,10 |
| 006-0972-20 A | 0641-24-2059 C | P | 20 | - | reduced bucket contact | red black | 0,055 to 0,15 | 26 to 30 | 1,01 to 2,10 |
| 006-0973-20 A | 0603-21-2059 C | S | 20 | - | reduced bucket contact | red black | 0,055 to 0,15 | 26 to 30 | 1,01 to 2,10 |
| 006-0044-20 A | DF 06-044-20 C | P | 20 | - | enlarged bucket contact | red purple | 0,38 to 0,93 | 18 to 22 | 1,01 to 2,10 |
| 006-0055-20 A | DF 06-A 055-20 C | S | 20 | - | enlarged bucket contact | red purple | 0,38 to 0,93 | 18 to 22 | 1,01 to 2,10 |
| 006-0982-20 | 0641-14-2000 | P | 20 | - | chromel contact | mark Ch | 0,22 to 0,60 | 20 to 24 | 1,01 to 2,10 |
| 006-0985-20 | 0603-16-2000 | S | 20 | - | chromel contact | mark Ch | 0,22 to 0,60 | 20 to 24 | 1,01 to 2,10 |
| 025-0404-20 | | P | 20 | - | chromel contact | mark Ch | 0,38 to 0,93 | 18 to 22 | 1,01 to 2,10 |
| 025-0405-20 | | S | 20 | - | chromel contact | mark Ch | 0,38 to 0,93 | 18 to 22 | 1,01 to 2,10 |
| 006-0983-20 | 0641-15-2000 | P | 20 | - | alumel contact | mark Al | 0,38 to 0,93 | 18 to 22 | 1,01 to 2,10 |
| 006-0984-20 | 0603-15-2000 | S | 20 | - | alumel contact | mark Al | 0,38 to 0,93 | 18 to 22 | 1,01 to 2,10 |
| 025-0402-20 | | P | 20 | - | alumel contact | mark Al | 0,38 to 0,93 | 18 to 22 | 1,01 to 2,10 |
| 025-0403-20 | | S | 20 | - | alumel contact | mark Al | 0,38 to 0,93 | 18 to 22 | 1,01 to 2,10 |
| 006-1060-20 | | P | 20 | - | constantan contact | - - | 0,22 to 0,60 | 20 to 24 | 1,01 to 2,10 |
| 006-1062-20 | | S | 20 | - | constantan contact | - - | 0,22 to 0,60 | 20 to 24 | 1,01 to 2,10 |
| 025-0406-20 | | P | 20 | - | constantan contact | - - | 0,38 to 0,93 | 18 to 22 | 1,01 to 2,10 |
| 025-0407-20 | | S | 20 | - | constantan contact | - - | 0,38 to 0,93 | 18 to 22 | 1,01 to 2,10 |
| 006-0937-16 A | 0641-12-1659 C | P | 16 | - | - | blue blue | 0,60 to 1,34 | 16 to 20 | 1,35 to 2,62 |
| 006-0912-16 A | 0603-33-1659 C | S | 16 | - | - | blue blue | 0,60 to 1,34 | 16 to 20 | 1,35 to 2,62 |
| 006-1102-16 A | | P | 16 | - | enlarged bucket contact | blue orange | 1,91 | 14 | 1,35 to 2,62 |
| 006-1104-16 A | | S | 16 | - | enlarged bucket contact | blue orange | 1,91 | 14 | 1,35 to 2,62 |
| 025-0870-16 A | | P | 16 | - | reduced bucket contact | blue black | 0,055 to 0,15 | 26 to 30 | 1,35 to 2,62 |
| 025-0871-16 A | | S | 16 | - | reduced bucket contact | blue black | 0,055 to 0,15 | 26 to 30 | 1,35 to 2,62 |
| 006-1168-16 | 109 026-16 | P | 16 | - | reduced bucket contact | blue red | 0,22 to 0,60 | 20 to 24 | 1,01 to 2,10 |
| 006-1169-16 | 109 027-16 | S | 16 | - | reduced bucket contact | blue red | 0,22 to 0,60 | 20 to 24 | 1,01 to 2,10 |
| 006-0937-12 A | 0641-32-1259 C | P | 12 | - | - | yellow yellow | 1,91 to 3,18 | 12 to 14 | 2,51 to 4,01 |
| 006-0912-12 A | 0603-32-1259 C | S | 12 | - | - | yellow yellow | 1,91 to 3,18 | 12 to 14 | 2,51 to 4,01 |
| 006-1157-12 A | 109 028 A | P | 12 | - | reduced bucket contact | yellow blue | 0,60 to 1,34 | 16 to 20 | 1,34 to 2,61 |
| 006-1159-12 A | 109 029 A | S | 12 | - | reduced bucket contact | yellow blue | 0,60 to 1,34 | 16 to 20 | 1,34 to 2,61 |
| 005-0893-08 | 101 -333-59 | P | 8 | 8 | - | - - | 5,30 to 8,98 | 8 to 10 | 3,80 to 5,15 |
| 005-0896-08 | 101 -334-59 | S | 8 | 8 | - | - - | 5,30 to 8,98 | 8 to 10 | 3,80 to 5,15 |
| 005-0257-08 | DF 05-257-08 | P | 8 | 87 | reduced bucket contact | - - | 5,30 | 10 | 3,80 to 5,15 |
| 005-0258-08 | DF 05-258-08 | S | 8 | 87 | reduced bucket contact | - - | 5,30 | 10 | 3,80 to 5,15 |
| 006-0041-08 | DF 06-A 041-08 | P | 8 | 88 | - | - - | 8,98 | 8 | 3,80 to 5,15 |
| 006-0040-08 | DF 06-A 040-08 | S | 8 | 88 | - | - - | 8,98 | 8 | 3,80 to 5,15 |

Note : Standard contacts supplied with connector
Reference to be order

Connector rear face



| TOOLS | | | | | | |
|--------------|--------|---------------|-------------|--|------------------------------------|---------------|
| Sealing plug | | Crimping tool | | Insertion and extraction tool | Extraction tool non wired contacts | |
| Reference | Color | Reference | Turret | Wired contacts | Reference | Alternate end |
| 4113-4-2001 | red | 057-0461-00 | 057-0462-00 | M 15570-20 | M 15571 | 105910 |
| 4113-4-2001 | red | 057-0461-00 | 057-0462-00 | M 15570-20 | M 15571 | 105910 |
| 4113-4-2001 | red | 057-0461-00 | 057-0462-00 | M 15570-20 | M 15571 | 105910 |
| 4113-4-2001 | red | 057-0461-00 | 057-0462-00 | M 15570-20 | M 15571 | 105910 |
| 4113-4-2001 | red | 057-0461-00 | 057-0462-00 | M 15570-20 | M 15571 | 105910 |
| 4113-4-2001 | red | 057-0461-00 | 057-0462-00 | M 15570-20 | M 15571 | 105910 |
| 4113-4-2001 | red | 057-0461-00 | 057-0462-00 | M 15570-20 | M 15571 | 105910 |
| 4113-4-2001 | red | 057-0461-00 | 057-0462-00 | M 15570-20 | M 15571 | 105910 |
| 4113-4-2001 | red | 057-0461-00 | 057-0462-00 | M 15570-20 | M 15571 | 105910 |
| 0613-1-1601 | blue | 057-0461-00 | 057-0462-00 | M 15570-16 | M 15571 | 105911 |
| 0613-1-1601 | blue | 057-0461-00 | 057-0462-00 | M 15570-16 | M 15571 | 105911 |
| 0613-1-1601 | blue | 057-0461-00 | 057-0462-00 | M 15570-16 | M 15571 | 105911 |
| 0613-1-1601 | blue | 057-0461-00 | 057-0462-00 | M 15570-16 | M 15571 | 105911 |
| 0613-1-1201 | yellow | 057-0461-00 | 057-0462-00 | M 15570-12 | M 15571 | 105912 |
| 0613-1-1201 | yellow | 057-0461-00 | 057-0462-00 | M 15570-12 | M 15571 | 105912 |
| 0613-4-0000 | green | 057-0461-00 | 057-0462-00 | M 15570-25 (insertion) M 15515-109 (extraction) | - | - |
| 0613-4-0000 | green | 057-0461-00 | 057-0462-00 | M 15570-25 (insertion) M 15515-109 (extraction) | - | - |
| 0613-4-0000 | green | 057-0461-00 | 057-0462-00 | M 15570-25 (insertion) M 15515-109 (extraction) | - | - |

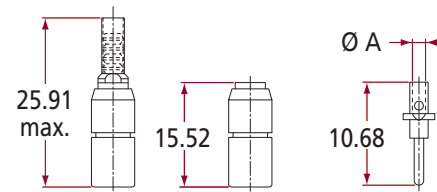
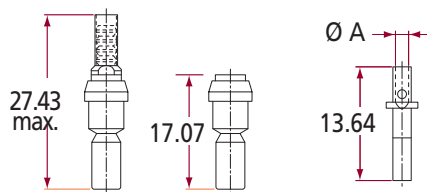
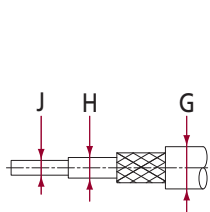

| Wires used | | | | Coax contact Index | CONTACTS | | | | | | | |
|--|--------|--------|--------|--------------------|----------------------------|------------------------|-------------------------|--------|----------------------------|------------------------|-------------------------|--------|
| Reference | G max. | H max. | J max. | | Male contacts | | | | Female contacts | | | |
| | | | | | Complete contact reference | Sub-assembly reference | Inner contact reference | Ø A mm | Complete contact reference | Sub-assembly reference | Inner contact reference | Ø A mm |
| RG 161/U RG 174/U RG 178/U RG 178 A/U RG 179/U RG 187/U RG 188/U RG 196/U | | | | Standard | 106467 | 106469 | 106472 | 0,81 | 106468 | 106470 | 106471 | 0,81 |
| RG 180/U RG 195/U | 3,94 | 2,62 | 0,76 | 1 | 0603-37-0000 | 106469 | 106472 | 0,81 | 0603-38-0000 | 106470 | 106471 | 0,81 |
| Special | 2,95 | 1,52 | 0,97 | 9 | 0603-39-0000 | 106469 | 0107-028-000 | 0,99 | 0603-40-0000 | 106470 | 4141-7-2600 | 0,99 |
| 50 PPDT | 3,90 | 2 | 0,70 | F1 | DF 05-A065-00-0059 | 106469 | 106472 | 0,81 | DF 05-A066-00-0059 | 106470 | 106471 | 0,81 |

Note : Standard contacts supplied with connector
 For wiring of coax contacts imperatively use the Directions for Wiring n° NC 025 011*

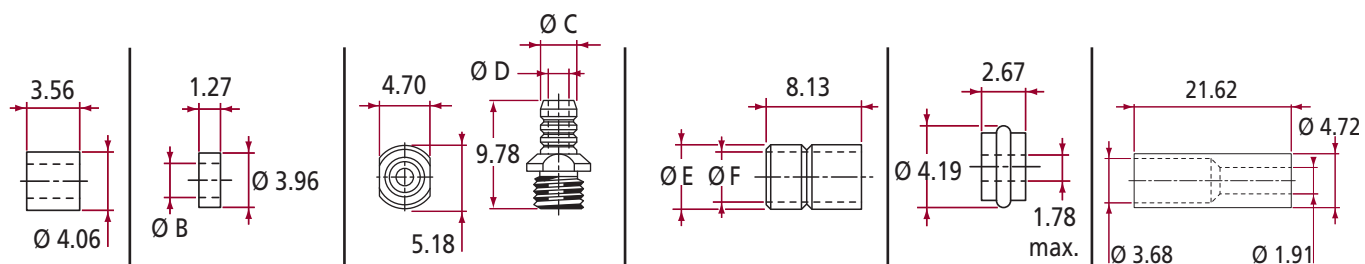

| COMMON PARTS | | | | | | | | | | |
|-------------------|------------------|------------|-----------------------------|------------|------------|---------------------------|------|------|--------------------------|--------------------------|
| Grommet reference | Insert reference | Ø B ± 0,05 | Supporting sleeve reference | Ø C ± 0,05 | Ø D ± 0,02 | Crimping sleeve reference | Ø E | Ø F | Sealing sleeve reference | Sealing sleeve reference |
| 105172 | 0614-1-0000 | 1,78 | 105551 | 2,36 | 1,67 | 5121-3-2601 | 3,91 | 3,04 | - | 100368 |
| 105172 | 0614-1-0001 | 2,74 | 105552 | 3,51 | 2,74 | 5121-3-2606 | 5,13 | 4,11 | - | - |
| 105172 | 0614-1-0000 | 1,78 | 105551 | 2,36 | 1,67 | 5121-3-2601 | 3,91 | 3,04 | - | 100368 |
| 105172 | 0614-1-0001 | 2,74 | DF 05-063-000 | 3,51 | 2,12 | 0108-002-001 | 5,10 | 4 | 207/8 | - |

| TOOLS FOR COAX | | | | | |
|----------------|--------------------------------|-------------|----------------------|----------------|-----------------|
| Coax index | External contact crimping tool | Positioner | Sleeve crimping tool | Insertion tool | Extraction tool |
| Standard | 057-0463-00 | 057-0464-00 | 20053 | M 15570-25 | M 15570-25 |
| 1 | 057-0463-00 | 057-0464-00 | 20052 | M 15570-25 | M 15570-25 |
| 9 | 057-0463-00 | 057-0464-00 | 20053 | M 15570-25 | M 15570-25 |
| F 1 | 057-0463-00 | 057-0464-00 | 20055 | M 15570-25 | M 15570-25 |

■ For cable clamp

| Size shell | Main bushing | Middle bushing | | |
|------------|--|--|---|--|
| 08 |  10 006-0005-08 | | | |
| 10 |  10 006-0005-10 | | | |
| 12 |  10 006-0005-12 |  47.5 Ø 5.6 006-0006-12 | | |
| 14 |  Ø 11.1 10 006-0005-14 |  44 Ø 7.9 006-0006-14 |  006-0006-12 | |
| 16 |  Ø 11.1 10 006-0005-16 |  006-0006-14 |  006-0006-12 | |
| 18 |  Ø 14.3 10 006-0005-18 |  40.5 Ø 11.1 006-0006-18 |  006-0006-14 |  006-0006-12 |
| 20 |  Ø 15.9 10 006-0005-20 |  37 Ø 14.3 006-0006-20 |  006-0006-18 |  006-0006-14 |
| 22 |  Ø 19 10 006-0005-22 |  33.5 Ø 15.9 006-0006-22 |  006-0006-20 |  006-0006-18 |
| 24 |  Ø 23.8 10 006-0005-24 |  30 Ø 19 006-0006-24 |  006-0006-22 |  006-0006-20 |



Mechanical

| | | |
|---------------------------|---------|---|
| Materials | Shell | : Steel |
| | Plating | : Tin over nickel plating |
| Insert | | : Compression glass ; silicone gasket |
| Insert retention in shell | | : The glass can withstand 70 bars of pressure differential without loss of mechanical or electrical characteristics |
| Contacts | Type | : Solder type |
| | Finish | : Gold as per MIL-G 45204 |
| Durability | | : 500 full coupling and uncoupling cycles |
| Temperature | | : - 55° C to + 200° C |
| Air leakage | | : Leakage inferior to $\leq 1 \times 10^{-7} \text{ cm}^3 / \text{hour}$ under a 1 bar differential pressure |
| Physical Shocks | | : 50 G in the 3 axes |

Electrical

| | | |
|--------------------------|------------------------|---|
| Withstanding voltage | at sea level | : Service 1 : 1500 V 50 Hz (R.M.S) Service 2 : 2300 V 50 Hz (R.M.S) |
| | in altitude at 15000 m | : Service 1 : 500 V Service 2 : 750 V |
| | in altitude at 21000 m | : Service 1 : 375 V Service 2 : 500 V |
| | in altitude at 33000 m | : Service 1 : 200 V Service 2 : 200 V |
| Insulation resistance | | : Higher than 5000 MΩ at 20° C at 65 % R.H |
| Contacts maximum current | | : Size 20 : 5 A. Size 16 : 10 A. Size 12 : 17 A. |
| Contact millivolt drop | | : Size 20 : 75 mv at 5 A. Size 16 : 100 mv at 10 A. Size 12 : 100 mv at 17 A. |

■ Square flange receptacle

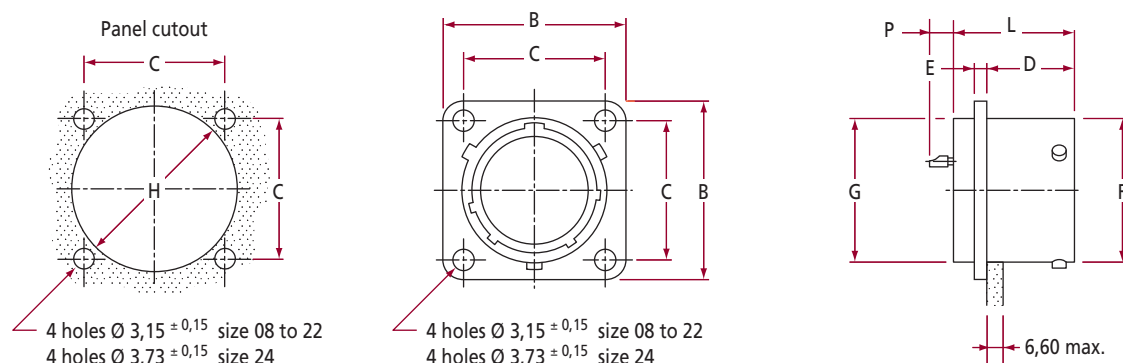

| Reference | B | C | D | E | F | G | L | P max. Sizes | | H |
|-------------------|-------|-----------|------------|------|-------|-------|-------|-----------------|-------|------------|
| | max. | $\pm 0,1$ | $\pm 0,15$ | max. | max. | max. | max. | 20 | 16-12 | +0 -0,2 |
| DBC 50H-08-**-P-* | 21,00 | 15,08 | 14,95 | 1,60 | 12,03 | 14,30 | 20,35 | 4,55 | 6,30 | 14,70 |
| DBC 50H-10-**-P-* | 24,20 | 18,26 | 14,95 | 1,60 | 15,01 | 17,10 | 20,35 | 4,55 | 6,30 | 17,50 |
| DBC 50H-12-**-P-* | 26,55 | 20,62 | 14,95 | 1,60 | 19,07 | 19,90 | 20,35 | 4,55 | 6,30 | 20,30 |
| DBC 50H-14-**-P-* | 28,95 | 23,02 | 14,95 | 1,60 | 22,24 | 23,05 | 20,35 | 4,55 | 6,30 | 23,45 |
| DBC 50H-16-**-P-* | 31,30 | 24,58 | 14,95 | 1,60 | 25,42 | 26,25 | 20,35 | 4,55 | 6,30 | 26,65 |
| DBC 50H-18-**-P-* | 33,70 | 26,98 | 14,95 | 1,60 | 28,60 | 29,40 | 20,35 | 4,55 | 6,30 | 29,80 |
| DBC 50H-20-**-P-* | 36,85 | 29,36 | 16,55 | 2,40 | 31,77 | 31,80 | 21,95 | 4,55 | 6,30 | 32,20 |
| DBC 50H-22-**-P-* | 39,95 | 31,76 | 16,55 | 2,40 | 34,94 | 34,95 | 22,75 | 3,70 | 5,50 | 35,35 |
| DBC 50H-24-**-P-* | 43,15 | 34,92 | 16,55 | 2,40 | 38,12 | 38,15 | 22,75 | 3,70 | 5,50 | 38,55 |

■ Single hole receptacle

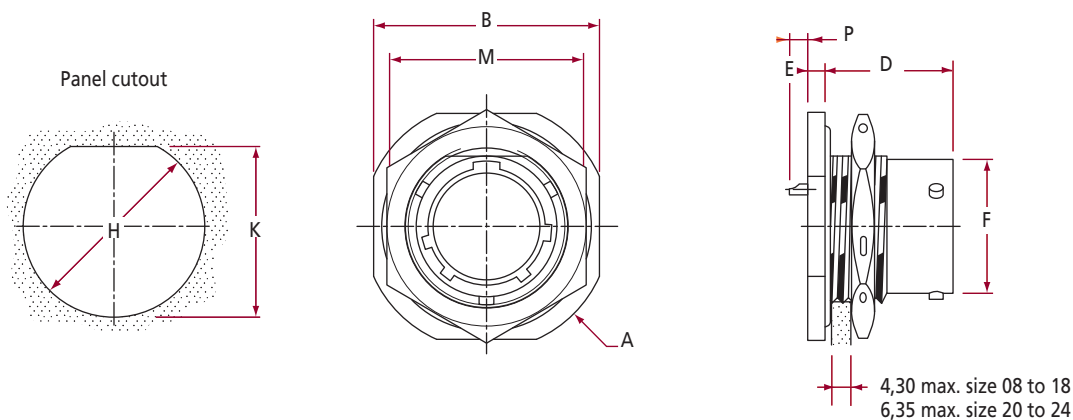

| Reference | A | B | D | E | F | H | K | M | P max. Sizes | |
|-------------------|-------|-------|------------|------|-------|------------|------------|-------|-----------------|-------|
| | max. | max. | $\pm 0,15$ | max. | max. | +0 -0,2 | +0 -0,2 | max. | 20 | 16-12 |
| DBC 54H-08-**-P-* | 27,35 | 24,20 | 17,78 | 2,85 | 12,03 | 14,65 | 13,85 | 19,20 | 3,40 | 5,20 |
| DBC 54H-10-**-P-* | 30,55 | 27,35 | 17,78 | 2,85 | 15,01 | 17,80 | 17,05 | 22,37 | 3,40 | 5,20 |
| DBC 54H-12-**-P-* | 35,30 | 32,15 | 17,78 | 2,85 | 19,07 | 22,55 | 21,15 | 27,12 | 3,40 | 5,20 |
| DBC 54H-14-**-P-* | 38,50 | 35,30 | 17,78 | 2,85 | 22,24 | 25,70 | 24,30 | 30,30 | 3,40 | 5,20 |
| DBC 54H-16-**-P-* | 41,65 | 38,50 | 17,78 | 2,85 | 25,42 | 28,90 | 27,45 | 33,47 | 3,40 | 5,20 |
| DBC 54H-18-**-P-* | 44,80 | 41,65 | 17,78 | 2,85 | 28,60 | 32,05 | 30,65 | 36,67 | 3,40 | 5,20 |
| DBC 54H-20-**-P-* | 49,60 | 46,40 | 19,43 | 3,70 | 31,77 | 35,25 | 33,80 | 39,82 | 2,55 | 2,55 |
| DBC 54H-22-**-P-* | 52,75 | 49,60 | 19,43 | 3,70 | 34,94 | 38,40 | 37,00 | 43,02 | 2,55 | 2,55 |
| DBC 54H-24-**-P-* | 55,95 | 52,75 | 20,17 | 3,70 | 38,12 | 41,60 | 40,15 | 46,17 | 2,55 | 2,55 |

Solder receptacle



| Reference | A | D1 | E | F | G | H | L | P max. Sizes | |
|-------------------|-------|------|------|-------|-------|-------|------------|--------------|-------|
| | max. | max. | max. | max. | max. | max. | +0 -0,2 | 20 | 16-12 |
| DBC 53H-08-**-P-* | 16,15 | 4,00 | 0,90 | 12,03 | 14,30 | 14,70 | 20,35 | 4,55 | 6,30 |
| DBC 53H-10-**-P-* | 19,30 | 4,00 | 0,90 | 15,01 | 17,50 | 17,10 | 20,35 | 4,55 | 6,30 |
| DBC 53H-12-**-P-* | 21,70 | 4,00 | 0,90 | 19,07 | 19,90 | 20,30 | 20,35 | 4,55 | 6,30 |
| DBC 53H-14-**-P-* | 24,90 | 4,00 | 0,90 | 22,24 | 23,45 | 23,05 | 20,35 | 4,55 | 6,30 |
| DBC 53H-16-**-P-* | 28,05 | 4,00 | 0,90 | 25,42 | 26,25 | 26,65 | 20,35 | 4,55 | 6,30 |
| DBC 53H-18-**-P-* | 31,20 | 4,00 | 0,90 | 28,60 | 29,40 | 29,80 | 20,35 | 4,55 | 6,30 |
| DBC 53H-20-**-P-* | 33,60 | 4,00 | 0,90 | 31,77 | 31,80 | 32,20 | 21,95 | 4,55 | 6,30 |
| DBC 53H-22-**-P-* | 36,80 | 4,80 | 0,90 | 34,94 | 34,95 | 35,35 | 22,75 | 3,70 | 5,50 |
| DBC 53H-24-**-P-* | 40,00 | 4,80 | 0,90 | 38,12 | 38,15 | 38,55 | 22,75 | 3,70 | 5,50 |



CONNECTEURS ELECTRIQUES DEUTSCH

17, rue Lavoisier z.i. n° 2 B.P. 117 27091 EVREUX CEDEX 09 (FRANCE) - Tél.: +33 (0)2 32 23 57 00 - Fax : +33 (0)2 32 23 58 00
E-mail : ced@deutsch.net - Web : www.deutsch.net - Réf.: CC 011-21 E Edition Mars 2008