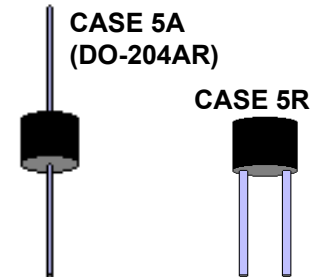


**DESCRIPTION**

These Microsemi 15 kW Transient Voltage Suppressors (TVSs) are designed for applications requiring protection of voltage-sensitive electronic devices that may be damaged by harsh or severe voltage transients including lightning per IEC61000-4-5 and class levels with various source impedances described herein. This series is generally available in 22 to 280 volt standoff voltages ( $V_{WM}$ ) in both unidirectional and bi-directional offered in two different package designs for axial and radial configurations. Consult factory for availability of the 17 and 18 Volt devices on a special order basis. Microsemi also offers numerous other TVS products to meet higher or lower power demands and special applications.

**IMPORTANT:** For the most current data, consult MICROSEMI's website: <http://www.microsemi.com>

**APPEARANCE**



**FEATURES**

- Available in both Unidirectional and Bidirectional construction (Bidirectional with C or CA suffix)
- Available in both axial-leaded and radial packages (include R prefix in part number for radial package option shown in figure as "case 5R," e.g. R15KP22A)
- Selections for 22 to 280 volt standoff voltages ( $V_{WM}$ )
- Suppresses transients up to 15 kW @ 10/1000  $\mu$ s and 100 kW @ 8/20  $\mu$ s (see Figure 1)
- Optional 100% **screening for avionics grade** is available by adding MA prefix to part number for added 100% temperature cycle -55°C to +125°C (10X) as well as surge (3X) and 24 hours HTRB with post test  $V_{BR}$  &  $I_D$  (in the operating direction for unidirectional or both directions for bidirectional)
- Options for screening in accordance with MIL-PRF-19500 for JANTX are available by adding MX prefix respectively to the part numbers.
- Moisture classification is Level 1 with no dry pack required per IPC/JEDEC J-STD-020B
- RoHS Compliant devices available by adding "e3" suffix

**APPLICATIONS / BENEFITS**

- Protection from switching transients and induced RF
- Fast response
- Protection from ESD, and EFT per IEC 61000-4-2 and IEC 61000-4-4
- Secondary lightning protection per IEC61000-4-5 with 42 Ohms source impedance:
  - Class 1,2,3,4: 15KP22A - 15KP280A or CA
  - Class 5: 15KP22A - 15KP280A or CA (short distance)
  - Class 5: 15KP22A - 15KP110A or CA (long distance)
- Secondary lightning protection per IEC61000-4-5 with 12 Ohms source impedance:
  - Class 1 & 2: 15KP22A to 15KP280A or CA
  - Class 3: 15KP22A to 15KP240A or CA
  - Class 4: 15KP22A to 15KP120A or CA
- Secondary lightning protection per IEC61000-4-5 with 2 Ohms source impedance:
  - Class 2: 15KP22A to 15KP220A or CA
  - Class 3: 15KP22A to 15KP110A or CA
  - Class 4: 15KP22A to 15KP54A or CA

**MAXIMUM RATINGS**

- Peak Pulse Power dissipation at 25°C: 15,000 watts at 10/1000  $\mu$ s (also see Figures 1 and 2)
- Impulse repetition rate (duty factor): 0.05%
- $t_{clamping}$  (0 volts to  $V_{(BR)}$  min.): < 100 ps theoretical for unidirectional and < 5 ns for bidirectional
- Operating and Storage temperature: -65°C to +150°C
- Thermal resistance: 20°C/W junction to lead, or 80°C/W junction to ambient when mounted on FR4 PC board with 4 mm<sup>2</sup> copper pads (1oz) and track width 1 mm, length 25 mm
- Steady-State Power dissipation: 6 watts at  $T_L = 30^\circ$ C, or 1.56 watts at  $T_A = 25^\circ$ C when mounted on FR4 PC board described for thermal resistance
- Forward Surge: 200 Amps 8.3 ms half-sine wave for unidirectional devices only
- Solder temperatures: 260°C for 10 s (maximum)

**MECHANICAL AND PACKAGING**

- CASE: Void-free transfer molded thermosetting epoxy body meeting UL94V-0
- FINISH: Tin-Lead or RoHS compliant annealed matte-Tin plating readily solderable per MIL-STD-750, method 2026
- MARKING: Body marked with part number
- POLARITY: Band denotes cathode for the axial-leaded package and a dot denotes cathode terminal for the radial package. Bidirectional not marked for polarity
- WEIGHT: 1.5 grams (approximate)
- TAPE & REEL option: Standard per EIA-296 for axial package (add "TR" suffix to part number)
- See package dimension on last page



15KP22 thru 15KP280CA, e3

15,000 W TRANSIENT VOLTAGE SUPPRESSOR

**ELECTRICAL CHARACTERISTICS**

MICROSEMI PART NUMBER (Note 2)	REVERSE STAND-OFF VOLTAGE $V_{WM}$ (Note 1)	MINIMUM BREAKDOWN VOLTAGE $V_{(BR)}$ @ $I_{(BR)}$		MAXIMUM CLAMPING VOLTAGE $V_C$ @ $I_{PP}$	MAXIMUM STANDBY CURRENT $I_D$ @ $V_{WM}$	MAXIMUM PEAK PULSE CURRENT $I_{PP}$ (FIG. 2)	MAXIMUM VOLTAGE TEMPERATURE VARIATION $\alpha_{V(BR)}$ mV/°C
	VOLTS	VOLTS	mA	VOLTS	µA	A	
15KP22	22	24.4	10	41.1	500	365	27
15KP22A	22	24.4	10	37.1	500	404	24
15KP24	24	26.7	5	45.0	150	333	30
15KP24A	24	26.7	5	40.7	150	369	27
15KP26	26	28.9	5	48.7	50	308	32
15KP26A	26	28.9	5	44.0	50	341	29
15KP28	28	31.1	5	52.4	25	286	35
15KP28A	28	31.1	5	47.5	25	316	31
15KP30	30	33.3	5	56.2	15	267	27
15KP30A	30	33.3	5	50.7	15	296	34
15KP33	33	36.7	5	60.6	10	248	42
15KP33A	33	36.7	5	54.8	10	274	38
15KP36	36	40.0	5	66.0	10	227	46
15KP36A	36	40.0	5	59.7	10	251	41
15KP40	40	44.4	5	72.8	10	206	51
15KP40A	40	44.4	5	65.8	10	228	46
15KP43	43	47.8	5	77.1	10	195	55
15KP43A	43	47.8	5	69.7	10	215	50
15KP45	45	50.0	5	80.7	10	186	57
15KP45A	45	50.0	5	73.0	10	205	52
15KP48	48	53.3	5	85.9	10	175	62
15KP48A	48	53.3	5	77.7	10	193	56
15KP51	51	56.7	5	91.5	10	164	66
15KP51A	51	56.7	5	82.8	10	181	60
15KP54	54	60.0	5	96.8	10	155	70
15KP54A	54	60.0	5	87.5	10	171	63
15KP58	58	64.4	5	104.0	10	144	76
15KP58A	58	64.4	5	94.0	10	160	68
15KP60	60	66.7	5	107.0	10	140	78
15KP60A	60	66.7	5	97.3	10	154	71
15KP64	64	71.1	5	115	10	130	84
15KP64A	64	71.1	5	104	10	144	76
15KP70	70	77.8	5	126	10	119	92
15KP70A	70	77.8	5	114	10	132	83
15KP75	75	83.3	5	135	10	111	100
15KP75A	75	83.3	5	122	10	123	89
15KP78	78	86.7	5	140	10	107	104
15KP78A	78	86.7	5	126	10	119	93
15KP85	85	94.4	5	152	10	99	113
15KP85A	85	94.4	5	137	10	109	102
15KP90	90	100	5	160	10	94	120
15KP90A	90	100	5	146	10	103	109
15KP100	100	111	5	179	10	84	134
15KP100A	100	111	5	162	10	93	121
15KP110	110	122	5	196	10	77	147
15KP110A	110	122	5	178	10	84	133
15KP120	120	133	5	214	10	70	161
15KP120A	120	133	5	193	10	78	145
15KP130	130	144	5	231	10	65	174
15KP130A	130	144	5	209	10	72	157
15KP150	150	167	5	268	10	56	202
15KP150A	150	167	5	243	10	62	183
15KP160	160	178	5	287	10	52	216
15KP160A	160	178	5	259	10	58	195

www.Microsemi.com

15KP22-15KP280CA, e3

MICROSEMI PART NUMBER (Note 2)	REVERSE STAND-OFF VOLTAGE $V_{WM}$ (Note 1)	MINIMUM BREAKDOWN VOLTAGE $V_{(BR)}$ @ $I_{(BR)}$		MAXIMUM CLAMPING VOLTAGE $V_C$ @ $I_{PP}$	MAXIMUM STANDBY CURRENT $I_D$ @ $V_{WM}$	MAXIMUM PEAK PULSE CURRENT $I_{PP}$ (FIG. 2)	MAXIMUM VOLTAGE TEMPERATURE VARIATION $\alpha_{V(BR)}$ mV/°C
	VOLTS	VOLTS	mA	VOLTS	$\mu A$	A	
15KP170	170	189	5	304	10	49	229
15KP170A	170	189	5	275	10	55	207
15KP180	180	200	5	321	10	47	242
15KP180A	180	200	5	291	10	52	219
15KP200	200	222	5	356	10	42	269
15KP200A	200	222	5	322	10	47	243
15KP220	220	245	5	393	10	38	297
15KP220A	220	245	5	356	10	42	269
15KP240	240	267	5	428	10	35	324
15KP240A	240	267	5	388	10	39	293
15KP260	260	289	5	464	10	32	352
15KP260A	260	289	5	419	10	36	317
15KP280	280	311	5	500	10	30	378
15KP280A	280	311	5	452	10	33	342

**NOTE 1:** Transient Voltage Suppressors are normally selected with reverse "Standoff Voltage"  $V_{WM}$  which should be equal to or greater than the dc or continuous peak operating voltage level.

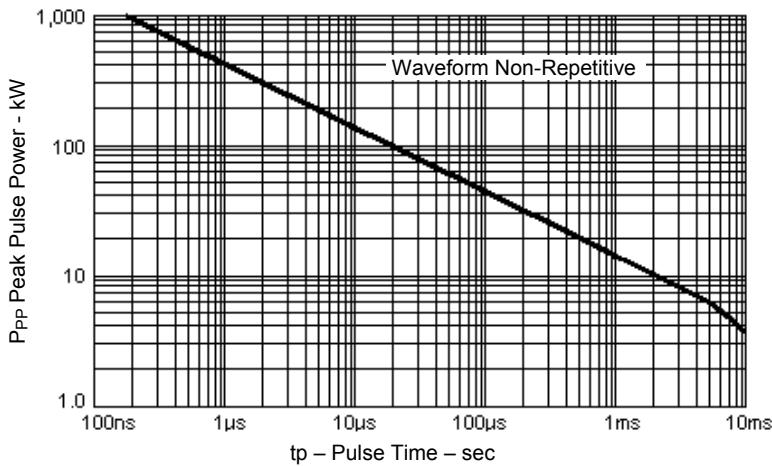
**NOTE 2:** For bidirectional construction, indicate a C or CA suffix after the part number.

\*\* Consult factory for availability of the 17 and 18 Volt devices on a special order basis.

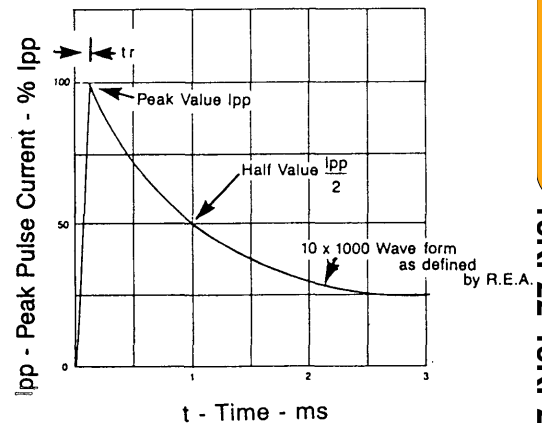
SYMBOLS & DEFINITIONS

Symbol	Definition	Symbol	Definition
$V_{WM}$	Working Peak (Standoff) Voltage	$I_{PP}$	Peak Pulse Current
$P_{PP}$	Peak Pulse Power	$V_C$	Clamping Voltage
$V_{(BR)}$	Breakdown Voltage	$I_{(BR)}$	Breakdown Current for $V_{(BR)}$
$I_D$	Standby Current		

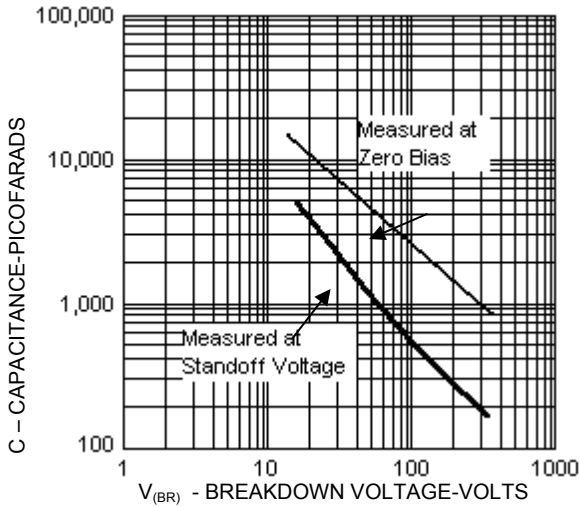
GRAPHS



**FIGURE 1**  
Peak Pulse Power vs. Pulse Time to 50% of Exponentially Decaying Pulse



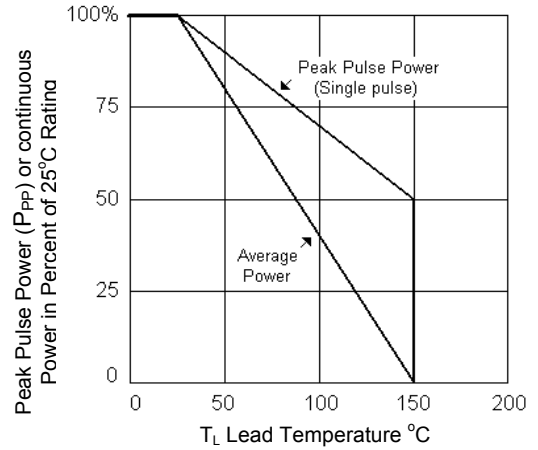
Test waveform parameters:  
 $t_r=10 \mu s$ ,  $t_p=1000 \mu s$   
**FIGURE 2**  
Pulse Waveform



**FIGURE 3**

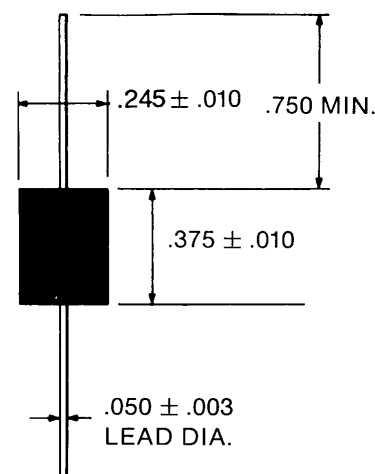
Typical Capacitance vs. Breakdown Voltage

**NOTE:** For Bidirectional Construction, indicate a C or CA suffix after part number. Capacitance will be one-half that shown in Figure 3.

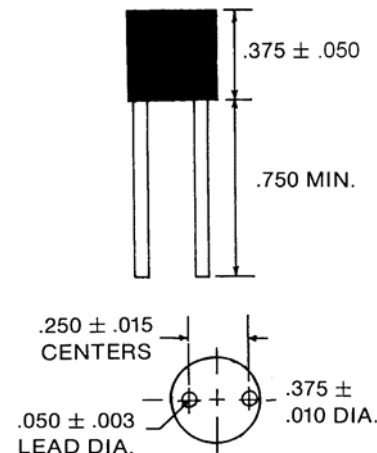


**FIGURE 4 Derating Curve**

**PACKAGE DIMENSIONS**



**CASE 5A**



**CASE 5R**

**NOTE:** Dimensions are in inches.