



400 W Surface Mount Transient Voltage Suppressor

| | | | | | |
|--|--|--|--------------|--|------------------------------|
| <p>DO-214AC (SMA)</p>  | <table style="width: 100%; border: none;"> <tr> <td style="width: 50%; text-align: center;">Voltage</td> <td style="width: 50%; text-align: center;">Power</td> </tr> <tr> <td style="text-align: center;">6.8 V to 540 V (Uni) 6.8 V to 260 V (Bid)</td> <td style="text-align: center;">400 W /ms (300W above 250 V)</td> </tr> </table> <div style="text-align: center; margin-top: 5px;">  </div> | Voltage | Power | 6.8 V to 540 V (Uni) 6.8 V to 260 V (Bid) | 400 W /ms (300W above 250 V) |
| | Voltage | Power | | | |
| | 6.8 V to 540 V (Uni) 6.8 V to 260 V (Bid) | 400 W /ms (300W above 250 V) | | | |
| | <p>FEATURES</p> <ul style="list-style-type: none"> Low profile package Ideal for automated placement 400 W peak pulse power capability with a 10/1000 μs waveform, repetitive rate (duty cycle): 0.01 % Excellent clamping capability Very fast response time Low incremental surge resistance Available in uni-directional and bi-directional Solder dip 260°C, 10s AEC-Q101 qualified Component in accordance to RoHS 2011/65/EU and WEEE 2002/96/EC Meets MSL level 1, per J-STD-020, LF maximum peak of 260° C Halogen-free available according to IEC 61249-2-21 definition |     | | | |
| <p>MECHANICAL DATA</p> <ul style="list-style-type: none"> Case: DO-214AC (SMA). Epoxy meets UL 94V-0 flammability rating. Polarity: For unidirectional types color band denotes cathode end. No marking on bidirectional types. Terminals: Matte tin plated leads, solderable per MIL-STD-750 Method 2026, J-STD-002 and JESD22-B102. Consumer grade, meets JESD 201 class 1A whisker test. HE3 suffix for high reliability grade, meets JESD 201 class 2 whisker test. | | | | | |
| <p>TYPICAL APPLICATIONS</p> <p>Used in sensitive electronics protection against voltage transients induced by inductive load switching and lighting on ICs, MOSFET, signal lines of sensor units for consumer, computer, industrial, automotive and telecommunication.</p> | | | | | |

Maximun Ratings and Electrical Characteristics at 25°C

| | | |
|-----------------|--|------------------|
| P_{PPM} | Peak Pulse Power Dissipation with 10/1000 μ s exponential pulse (Note 3) | 400 W, 300W |
| I_{FSM} | Peak Forward Surge Current 8.3 ms. (Note 1) (Jedec Method) (Note 2) | 40 A |
| V_F | Max. forward voltage drop at $I_F = 25$ A (Note 1) | 3.5 V |
| $T_J - T_{STG}$ | Operating Junction and Storage Temperature Range | - 65 to + 150 °C |

Notes: 1. Only for Unidirectional
2. Mounted on 0.31 x 0.31" (8.0 x 8.0 mm) copper pads to each terminal
3. Rating is 300W above 250V.

400 W Surface Mount Transient Voltage Suppressor

Ordering information

| PREFERRED P/N | PACKAGE CODE | DELIVERY MODE | BASE QUANTITY | UNIT WEIGHT (g) |
|--------------------|--|----------------------------|---------------|-----------------|
| P4SMA33A TRTB | TRTB | 13" diameter tape and reel | 7,500 | 0.060 |
| P4SMA33A TRTS | TRTS | 7" diameter tape and reel | 1,500 | 0.060 |
| PSMA33A HE3 TRTB | TRTB | 13" diameter tape and reel | 7,500 | 0.060 |
| P4SMA33A HE3 TRTS | TRTS | 7" diameter tape and reel | 1,500 | 0.060 |
| P4MA33A HF TRTB | TRTB | 13" diameter tape and reel | 7,500 | 0.060 |
| P4SMA33CA TRTB | TRTB | 13" diameter tape and reel | 7,500 | 0.060 |
| P4SMA33CA TRTS | TRTS | 7" diameter tape and reel | 1,500 | 0.060 |
| P4SMA33CA HE3 TRTB | TRTB | 13" diameter tape and reel | 7,500 | 0.060 |
| P4SMA33CA HE3 TRTS | TRTS </td <td>7" diameter tape and reel</td> <td>1,500</td> <td>0.060</td> | 7" diameter tape and reel | 1,500 | 0.060 |
| P4SMA33CA HF TRTB | TRTB | 13" diameter tape and reel | 7,500 | 0.060 |

Package Outline Dimensions: (mm) DO-214AC (SMA)

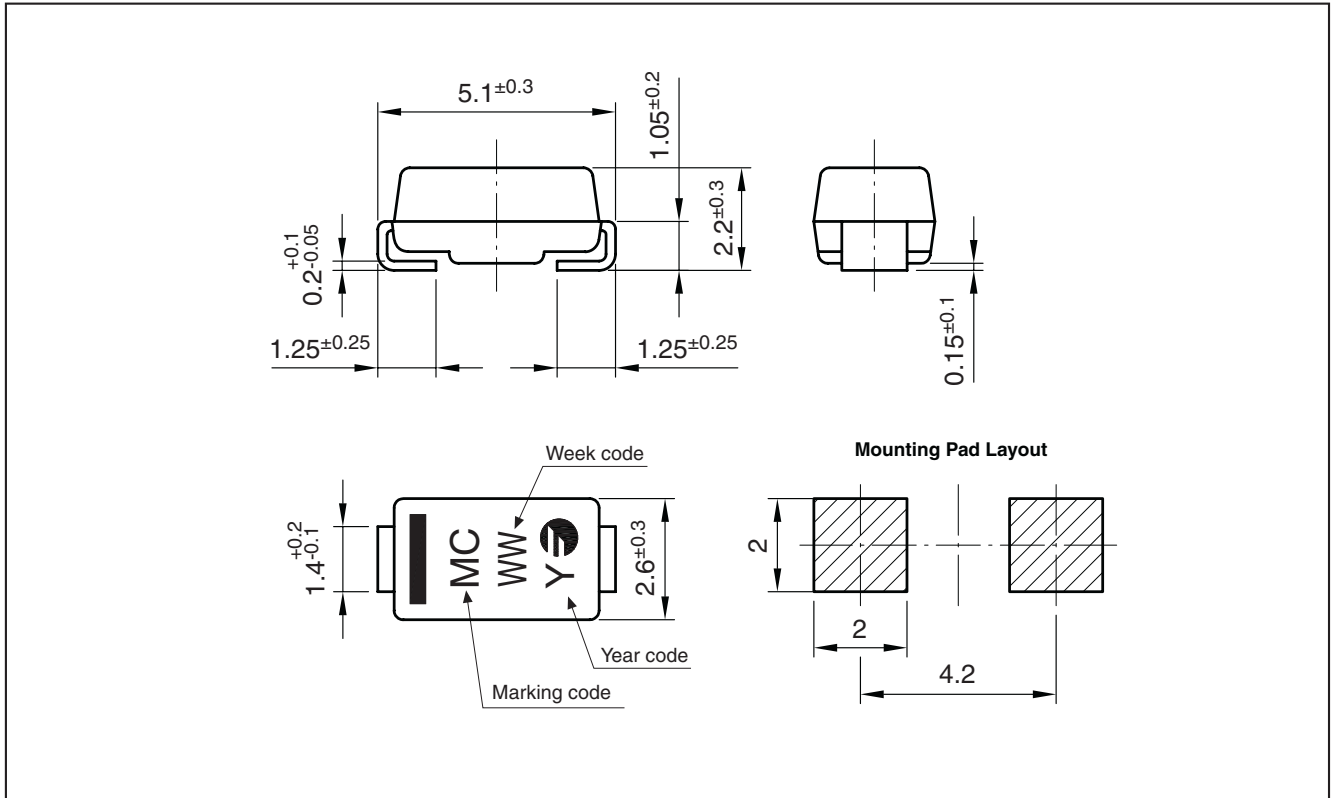

400 W Surface Mount Transient Voltage Suppressor

| Type | | Maximum Reverse Leakage Current | | (1) Breakdown Voltage | | | I_R | Max. Clamping Voltage | |
|----------------|--------------|---------------------------------|----------|-----------------------|----------------------|----------------------|-------|-----------------------|----------------------|
| | | I_{RM} at V_{RM} | V_{RM} | V_{BR} at V_{RM} | V_{BR} at V_{RM} | V_{BR} at V_{RM} | | V_{CL} at I_{PP} | V_{CL} at I_{PP} |
| Unidirectional | Marking Code | (μ A) | (V) | Min. | Nom. | Max. | (mA) | (V) | (A) |
| P4SMA6V8 | AD | 1000 | 5.50 | 6.12 | 6.8 | 7.48 | 10 | 10.8 | 38 |
| P4SMA6V8A | AE | 1000 | 5.80 | 6.45 | 6.8 | 7.14 | 10 | 10.5 | 40 |
| P4SMA7V5 | AF | 500 | 6.05 | 6.75 | 7.5 | 8.25 | 10 | 11.7 | 36 |
| P4SMA7V5A | AG | 500 | 6.40 | 7.13 | 7.5 | 7.88 | 10 | 11.3 | 37 |
| P4SMA8V2 | AH | 200 | 6.63 | 7.38 | 8.2 | 9.02 | 10 | 12.5 | 33 |
| P4SMA8V2A | AK | 200 | 7.02 | 7.79 | 8.2 | 8.61 | 10 | 12.1 | 35 |
| P4SMA9V1 | AL | 50 | 7.37 | 8.19 | 9.1 | 10.0 | 1 | 13.8 | 30 |
| P4SMA9V1A | AM | 50 | 7.78 | 8.65 | 9.1 | 9.55 | 1 | 13.4 | 31 |
| P4SMA10 | AN | 10 | 8.10 | 9.00 | 10 | 11.0 | 1 | 15.0 | 28 |
| P4SMA10A | AP | 10 | 8.55 | 9.50 | 10 | 10.5 | 1 | 14.5 | 29 |
| P4SMA11 | AQ | 5 | 8.92 | 9.90 | 11 | 12.1 | 1 | 16.2 | 26 |
| P4SMA11A | AR | 5 | 9.40 | 10.5 | 11 | 11.6 | 1 | 15.6 | 27 |
| P4SMA12 | AS | 1 | 9.72 | 10.8 | 12 | 13.2 | 1 | 17.3 | 24 |
| P4SMA12A | AT | 1 | 10.2 | 11.4 | 12 | 12.6 | 1 | 16.7 | 25 |
| P4SMA13 | AU | 1 | 10.5 | 11.7 | 13 | 14.3 | 1 | 19.0 | 22 |
| P4SMA13A | AV | 1 | 11.1 | 12.4 | 13 | 13.7 | 1 | 18.2 | 23 |
| P4SMA15 | AW | 1 | 12.1 | 13.5 | 15 | 16.5 | 1 | 22.0 | 19 |
| P4SMA15A | AX | 1 | 12.8 | 14.3 | 15 | 15.8 | 1 | 21.2 | 20 |
| P4SMA16 | AY | 1 | 12.9 | 14.4 | 16 | 17.6 | 1 | 23.5 | 18 |
| P4SMA16A | AZ | 1 | 13.6 | 15.2 | 16 | 16.8 | 1 | 22.5 | 19 |
| P4SMA18 | BD | 1 | 14.5 | 16.2 | 18 | 19.8 | 1 | 26.5 | 16 |
| P4SMA18A | BE | 1 | 15.3 | 17.1 | 18 | 18.9 | 1 | 25.5 | 17 |
| P4SMA20 | BF | 1 | 16.2 | 18.0 | 20 | 22.0 | 1 | 29.1 | 14 |
| P4SMA20A | BG | 1 | 17.1 | 19.0 | 20 | 21.0 | 1 | 27.7 | 15 |
| P4SMA22 | BH | 1 | 17.8 | 19.8 | 22 | 24.2 | 1 | 31.9 | 13 |
| P4SMA22A | BK | 1 | 18.8 | 20.9 | 22 | 23.1 | 1 | 30.6 | 14 |
| P4SMA24 | BL | 1 | 19.4 | 21.6 | 24 | 26.4 | 1 | 34.7 | 12 |
| P4SMA24A | BM | 1 | 20.5 | 22.8 | 24 | 25.2 | 1 | 33.2 | 13 |
| P4SMA27 | BN | 1 | 21.8 | 24.3 | 27 | 29.7 | 1 | 39.1 | 11 |
| P4SMA27A | BP | 1 | 23.1 | 25.7 | 27 | 28.4 | 1 | 37.5 | 11.2 |
| P4SMA30 | BQ | 1 | 24.3 | 27.0 | 30 | 33.0 | 1 | 43.5 | 10 |
| P4SMA30A | BR | 1 | 25.6 | 28.5 | 30 | 31.5 | 1 | 41.4 | 10 |
| P4SMA33 | BS | 1 | 26.8 | 29.7 | 33 | 36.3 | 1 | 47.7 | 9 |
| P4SMA33A | BT | 1 | 28.2 | 31.4 | 33 | 34.7 | 1 | 45.7 | 9 |
| P4SMA36 | BU | 1 | 29.1 | 32.4 | 36 | 39.6 | 1 | 52.0 | 8 |
| P4SMA36A | BV | 1 | 30.8 | 34.2 | 36 | 37.8 | 1 | 49.9 | 8.4 |
| P4SMA39 | BW | 1 | 31.6 | 35.1 | 39 | 42.9 | 1 | 56.4 | 7.4 |
| P4SMA39A | BX | 1 | 33.3 | 37.1 | 39 | 41.0 | 1 | 53.9 | 7.8 |

(1) Tested with pulses.
Pulse test: $t_p \leq 50$ ms; $\delta < 2\%$

400 W Surface Mount Transient Voltage Suppressor

| Type | | Maximum Reverse Leakage Current I_{RM} at V_{RM} | | (1) Breakdown Voltage V_{BR} at I_R (V) | | | Max. Clamping Voltage V_{CL} at I_{PP} max. 1 ms. Expo. | | |
|----------------|--------------|---|------|---|------|------|---|------|------|
| Unidirectional | Marking Code | (μ A) | (V) | Min. | Nom. | Max. | (mA) | (V) | (A) |
| P4SMA43 | BY | 1 | 34.8 | 38.7 | 43 | 47.3 | 1 | 61.9 | 6.8 |
| P4SMA43A | BZ | 1 | 36.8 | 40.9 | 43 | 45.2 | 1 | 59.3 | 7.1 |
| P4SMA47 | CD | 1 | 38.1 | 42.3 | 47 | 51.7 | 1 | 67.8 | 6.2 |
| P4SMA47A | CE | 1 | 40.2 | 44.7 | 47 | 49.4 | 1 | 64.8 | 6.4 |
| P4SMA51 | CF | 1 | 41.3 | 45.9 | 51 | 56.1 | 1 | 73.5 | 5.7 |
| P4SMA51A | CG | 1 | 43.6 | 48.5 | 51 | 53.6 | 1 | 70.1 | 6.0 |
| P4SMA56 | CH | 1 | 45.4 | 50.4 | 56 | 61.6 | 1 | 80.5 | 5.2 |
| P4SMA56A | CK | 1 | 47.8 | 53.2 | 56 | 58.8 | 1 | 77.0 | 5.5 |
| P4SMA62 | CL | 1 | 50.2 | 55.8 | 62 | 68.2 | 1 | 89.0 | 4.7 |
| P4SMA62A | CM | 1 | 53.0 | 58.9 | 62 | 65.1 | 1 | 85.0 | 5.0 |
| P4SMA68 | CN | 1 | 55.1 | 61.2 | 68 | 74.8 | 1 | 98.0 | 4.3 |
| P4SMA68A | CP | 1 | 58.1 | 64.6 | 68 | 71.4 | 1 | 92.0 | 4.6 |
| P4SMA75 | CQ | 1 | 60.7 | 67.5 | 75 | 82.5 | 1 | 108 | 3.9 |
| P4SMA75A | CR | 1 | 64.1 | 71.3 | 75 | 78.8 | 1 | 103 | 4.1 |
| P4SMA82 | CS | 1 | 66.4 | 73.8 | 82 | 90.2 | 1 | 118 | 3.6 |
| P4SMA82A | CT | 1 | 70.1 | 77.9 | 82 | 86.1 | 1 | 113 | 3.7 |
| P4SMA91 | CU | 1 | 73.7 | 81.9 | 91 | 100 | 1 | 131 | 3.2 |
| P4SMA91A | CV | 1 | 77.8 | 86.5 | 91 | 95.5 | 1 | 125 | 3.4 |
| P4SMA100 | CW | 1 | 81.0 | 90.0 | 100 | 110 | 1 | 144 | 2.9 |
| P4SMA100A | CX | 1 | 85.5 | 95.0 | 100 | 105 | 1 | 137 | 3.1 |
| P4SMA110 | CY | 1 | 89.2 | 99.0 | 110 | 121 | 1 | 158 | 2.7 |
| P4SMA110A | CZ | 1 | 94.0 | 105 | 110 | 116 | 1 | 152 | 2.8 |
| P4SMA120 | DD | 1 | 97.2 | 108 | 120 | 132 | 1 | 173 | 2.4 |
| P4SMA120A | DE | 1 | 102 | 114 | 120 | 126 | 1 | 165 | 2.5 |
| P4SMA130 | DF | 1 | 105 | 117 | 130 | 143 | 1 | 187 | 2.2 |
| P4SMA130A | DG | 1 | 111 | 124 | 130 | 137 | 1 | 179 | 2.3 |
| P4SMA150 | DH | 1 | 121 | 135 | 150 | 165 | 1 | 215 | 2.0 |
| P4SMA150A | DL | 1 | 128 | 143 | 150 | 158 | 1 | 207 | 2.0 |
| P4SMA160 | DM | 1 | 130 | 144 | 160 | 176 | 1 | 230 | 1.8 |
| P4SMA160A | DN | 1 | 136 | 152 | 160 | 168 | 1 | 219 | 1.9 |
| P4SMA170 | DP | 1 | 138 | 153 | 170 | 187 | 1 | 244 | 1.7 |
| P4SMA170A | DQ | 1 | 145 | 162 | 170 | 179 | 1 | 234 | 1.8 |
| P4SMA180 | DR | 1 | 146 | 162 | 180 | 198 | 1 | 258 | 1.6 |
| P4SMA180A | DS | 1 | 154 | 171 | 180 | 189 | 1 | 246 | 1.7 |
| P4SMA200 | DT | 1 | 162 | 180 | 200 | 220 | 1 | 287 | 1.5 |
| P4SMA200A | DU | 1 | 171 | 190 | 200 | 210 | 1 | 274 | 1.53 |
| P4SMA220 | DV | 1 | 175 | 198 | 220 | 242 | 1 | 344 | 1.16 |
| P4SMA220A | DX | 1 | 185 | 209 | 220 | 231 | 1 | 328 | 1.22 |
| P4SMA250A | DW | 1 | 214 | 237 | 250 | 263 | 1 | 344 | 0.91 |
| P4SMA300A | DY | 1 | 256 | 285 | 300 | 315 | 1 | 414 | 0.73 |
| P4SMA350A | DZ | 1 | 300 | 333 | 350 | 368 | 1 | 482 | 0.62 |
| P4SMA400A | DJ | 1 | 342 | 380 | 400 | 420 | 1 | 548 | 0.55 |
| P4SMA440A | DK | 1 | 376 | 418 | 440 | 462 | 1 | 602 | 0.5 |
| P4SMA480A | WJ | 1 | 408 | 456 | 480 | 504 | 1 | 658 | 0.46 |
| P4SMA510A | WL | 1 | 434 | 485 | 510 | 535 | 1 | 698 | 0.43 |
| P4SMA540A | WN | 1 | 459 | 513 | 540 | 567 | 1 | 740 | 0.41 |

(1) Tested with pulses.
Pulse test: $t_p \leq 50$ ms; $\delta < 2\%$

400 W Surface Mount Transient Voltage Suppressor

| Type | | Maximum Reverse Leakage Current I_{RM} at V_{RM} | | (1) Breakdown Voltage V_{BR} at I_R | | | | Max. Clamping Voltage V_{CL} at I_{pp} max. 1ms. Expo. | |
|---------------|--------------|---|------|--|------|------|------|--|------|
| Bidirectional | Marking Code | (μA) | (V) | Min. | Nom. | Max. | (mA) | (V) | (A) |
| P4SMA6V8C | RA | 1000 | 5.50 | 6.12 | 6.8 | 7.48 | 10 | 10.8 | 38 |
| P4SMA6V8CA | RB | 1000 | 5.80 | 6.45 | 6.8 | 7.14 | 10 | 10.5 | 38.1 |
| P4SMA7V5C | RC | 500 | 6.05 | 6.75 | 7.5 | 8.25 | 10 | 11.7 | 36 |
| P4SMA7V5CA | RD | 500 | 6.40 | 7.13 | 7.5 | 7.88 | 10 | 11.3 | 35.4 |
| P4SMA8V2C | RE | 200 | 6.63 | 7.38 | 8.2 | 9.02 | 10 | 12.5 | 33 |
| P4SMA8V2CA | RF | 200 | 7.02 | 7.79 | 8.2 | 8.61 | 10 | 12.1 | 33.1 |
| P4SMA9V1C | RG | 50 | 7.37 | 8.19 | 9.1 | 10.0 | 1 | 13.8 | 30 |
| P4SMA9V1CA | RH | 50 | 7.78 | 8.65 | 9.1 | 9.55 | 1 | 13.4 | 29.9 |
| P4SMA10C | RI | 10 | 8.10 | 9.00 | 10 | 11.0 | 1 | 15.0 | 28 |
| P4SMA10CA | RJ | 10 | 8.55 | 9.50 | 10 | 10.5 | 1 | 14.5 | 27.6 |
| P4SMA11C | RK | 5 | 8.92 | 9.90 | 11 | 12.1 | 1 | 16.2 | 26 |
| P4SMA11CA | RL | 5 | 9.40 | 10.5 | 11 | 11.6 | 1 | 15.6 | 25.6 |
| P4SMA12C | RM | 1 | 9.72 | 10.8 | 12 | 13.2 | 1 | 17.3 | 24 |
| P4SMA12CA | RN | 1 | 10.2 | 11.4 | 12 | 12.6 | 1 | 16.7 | 24 |
| P4SMA13C | RO | 1 | 10.5 | 11.7 | 13 | 14.3 | 1 | 19.0 | 22 |
| P4SMA13CA | RP | 1 | 11.1 | 12.4 | 13 | 13.7 | 1 | 18.2 | 22 |
| P4SMA15C | RR | 1 | 12.1 | 13.5 | 15 | 16.5 | 1 | 22.0 | 19 |
| P4SMA15CA | RS | 1 | 12.8 | 14.3 | 15 | 15.8 | 1 | 21.2 | 18.9 |
| P4SMA16C | RT | 1 | 12.9 | 14.4 | 16 | 17.6 | 1 | 23.5 | 18 |
| P4SMA16CA | RU | 1 | 13.6 | 15.2 | 16 | 16.8 | 1 | 22.5 | 17.8 |
| P4SMA18C | RV | 1 | 14.5 | 16.2 | 18 | 19.8 | 1 | 26.5 | 16 |
| P4SMA18CA | CC | 1 | 15.3 | 17.1 | 18 | 18.9 | 1 | 25.5 | 17 |
| P4SMA20C | RX | 1 | 16.2 | 18.0 | 20 | 22.0 | 1 | 29.1 | 14 |
| P4SMA20CA | RY | 1 | 17.1 | 19.0 | 20 | 21.0 | 1 | 27.7 | 14.4 |
| P4SMA22C | RZ | 1 | 17.8 | 19.8 | 22 | 24.2 | 1 | 31.9 | 13 |
| P4SMA22CA | SA | 1 | 18.8 | 20.9 | 22 | 23.1 | 1 | 30.6 | 13.1 |
| P4SMA24C | SB | 1 | 19.4 | 21.6 | 24 | 26.4 | 1 | 34.7 | 12 |
| P4SMA24CA | SC | 1 | 20.5 | 22.8 | 24 | 25.2 | 1 | 33.2 | 12 |
| P4SMA27C | SD | 1 | 21.8 | 24.3 | 27 | 29.7 | 1 | 39.1 | 11 |
| P4SMA27CA | SE | 1 | 23.1 | 25.7 | 27 | 28.4 | 1 | 37.5 | 10.9 |
| P4SMA30C | SF | 1 | 24.3 | 27.0 | 30 | 33.0 | 1 | 43.5 | 10 |
| P4SMA30CA | SG | 1 | 25.6 | 28.5 | 30 | 31.5 | 1 | 41.4 | 9.7 |
| P4SMA33C | SH | 1 | 26.8 | 29.7 | 33 | 36.3 | 1 | 47.7 | 9 |
| P4SMA33CA | SI | 1 | 28.2 | 31.4 | 33 | 34.7 | 1 | 45.7 | 9 |
| P4SMA36C | SJ | 1 | 29.1 | 32.4 | 36 | 39.6 | 1 | 52.0 | 8 |
| P4SMA36CA | SK | 1 | 30.8 | 34.2 | 36 | 37.8 | 1 | 49.9 | 8 |
| P4SMA39C | SL | 1 | 31.6 | 35.1 | 39 | 42.9 | 1 | 56.4 | 7.4 |
| P4SMA39CA | SM | 1 | 33.3 | 37.1 | 39 | 41.0 | 1 | 53.9 | 7.4 |

(1) Tested with pulses.
Pulse test: $t_p \leq 50$ ms; $\delta < 2\%$

400 W Surface Mount Transient Voltage Suppressor

| Type | | Maximum Reverse Leakage Current | | (1) Breakdown Voltage | | | | Max. Clamping Voltage | |
|---------------|--------------|---------------------------------|----------|-----------------------|------|------|----------------------|-----------------------|------|
| | | I_{RM} at V_{RM} | V_{RM} | V_{BR} at I_R | | | V_{CL} at I_{pp} | max. 1ms. Expo. | |
| Bidirectional | Marking Code | (μ A) | (V) | Min. | Nom. | Max. | (mA) | (V) | (A) |
| P4SMA43C | SN | 1 | 34.8 | 38.7 | 43 | 47.3 | 1 | 61.9 | 6.8 |
| P4SMA43CA | SO | 1 | 36.8 | 40.9 | 43 | 45.2 | 1 | 59.3 | 6.7 |
| P4SMA47C | SP | 1 | 38.1 | 42.3 | 47 | 51.7 | 1 | 67.8 | 6.2 |
| P4SMA47CA | SR | 1 | 40.2 | 44.7 | 47 | 49.4 | 1 | 64.8 | 6.2 |
| P4SMA51C | SS | 1 | 41.3 | 45.9 | 51 | 56.1 | 1 | 73.5 | 5.7 |
| P4SMA51CA | CA | 1 | 43.6 | 48.5 | 51 | 53.6 | 1 | 70.1 | 5.7 |
| P4SMA56C | ST | 1 | 45.4 | 50.4 | 56 | 61.6 | 1 | 80.5 | 5.2 |
| P4SMA56CA | CB | 1 | 47.8 | 53.2 | 56 | 58.8 | 1 | 77.0 | 5.2 |
| P4SMA62C | SU | 1 | 50.2 | 55.8 | 62 | 68.2 | 1 | 89.0 | 4.7 |
| P4SMA62CA | CI | 1 | 53.0 | 58.9 | 62 | 65.1 | 1 | 85.0 | 4.7 |
| P4SMA68C | SW | 1 | 55.1 | 61.2 | 68 | 74.8 | 1 | 98.0 | 4.3 |
| P4SMA68CA | UY | 1 | 58.1 | 64.6 | 68 | 71.4 | 1 | 92.0 | 4.3 |
| P4SMA75C | SY | 1 | 60.7 | 67.5 | 75 | 82.5 | 1 | 108 | 3.9 |
| P4SMA75CA | SZ | 1 | 64.1 | 71.3 | 75 | 78.8 | 1 | 103 | 3.9 |
| P4SMA82C | WA | 1 | 66.4 | 73.8 | 82 | 90.2 | 1 | 118 | 3.6 |
| P4SMA82CA | PB | 1 | 70.1 | 77.9 | 82 | 86.1 | 1 | 113 | 3.5 |
| P4SMA91C | WC | 1 | 73.7 | 81.9 | 91 | 100 | 1 | 131 | 3.2 |
| P4SMA91CA | PC | 1 | 77.8 | 86.5 | 91 | 95.5 | 1 | 125 | 3.2 |
| P4SMA100C | WE | 1 | 81.0 | 90.00 | 100 | 110 | 1 | 144 | 2.9 |
| P4SMA100CA | CJ | 1 | 85.5 | 95.0 | 100 | 105 | 1 | 137 | 2.9 |
| P4SMA110C | WG | 1 | 89.2 | 99.0 | 110 | 121 | 1 | 158 | 2.7 |
| P4SMA110CA | PJ | 1 | 94.0 | 105 | 110 | 116 | 1 | 152 | 2.0 |
| P4SMA120C | WI | 1 | 97.2 | 108 | 120 | 132 | 1 | 173 | 2.4 |
| P4SMA120CA | PO | 1 | 102 | 114 | 120 | 126 | 1 | 165 | 1.8 |
| P4SMA130C | WK | 1 | 105 | 117 | 130 | 143 | 1 | 187 | 2.2 |
| P4SMA130CA | NA | 1 | 111 | 124 | 130 | 137 | 1 | 179 | 1.7 |
| P4SMA150C | WM | 1 | 121 | 135 | 150 | 165 | 1 | 215 | 2.0 |
| P4SMA150CA | NB | 1 | 128 | 143 | 150 | 158 | 1 | 207 | 1.4 |
| P4SMA160C | WO | 1 | 130 | 144 | 160 | 176 | 1 | 230 | 1.8 |
| P4SMA160CA | NC | 1 | 136 | 152 | 160 | 168 | 1 | 219 | 1.4 |
| P4SMA170C | WR | 1 | 138 | 153 | 170 | 187 | 1 | 244 | 1.7 |
| P4SMA170CA | NI | 1 | 145 | 162 | 170 | 179 | 1 | 234 | 1.3 |
| P4SMA180C | WT | 1 | 146 | 162 | 180 | 198 | 1 | 258 | 1.6 |
| P4SMA180CA | NO | 1 | 154 | 171 | 180 | 189 | 1 | 246 | 1.2 |
| P4SMA200C | WV | 1 | 162 | 180 | 200 | 220 | 1 | 287 | 1.5 |
| P4SMA200CA | MA | 1 | 171 | 190 | 200 | 210 | 1 | 274 | 1.45 |
| P4SMA220C | WX | 1 | 175 | 198 | 220 | 242 | 1 | 344 | 1.16 |
| P4SMA220CA | MB | 1 | 185 | 209 | 220 | 231 | 1 | 328 | 1.21 |
| P4SMA250C | MI | 1 | 202 | 225 | 250 | 275 | 1 | 360 | 1.11 |
| P4SMA250CA | MJ | 1 | 214 | 237 | 250 | 263 | 1 | 344 | 1.16 |
| P4SMA260CA | MO | 1 | 232 | 247 | 260 | 273 | 1 | 360 | 1.11 |

(1) Tested with pulses.
Pulse test: $t_p \leq 50$ ms; $\delta < 2\%$

400 W Surface Mount Transient Voltage Suppressor

Ratings and Characteristics (Ta 25 °C unless otherwise noted)

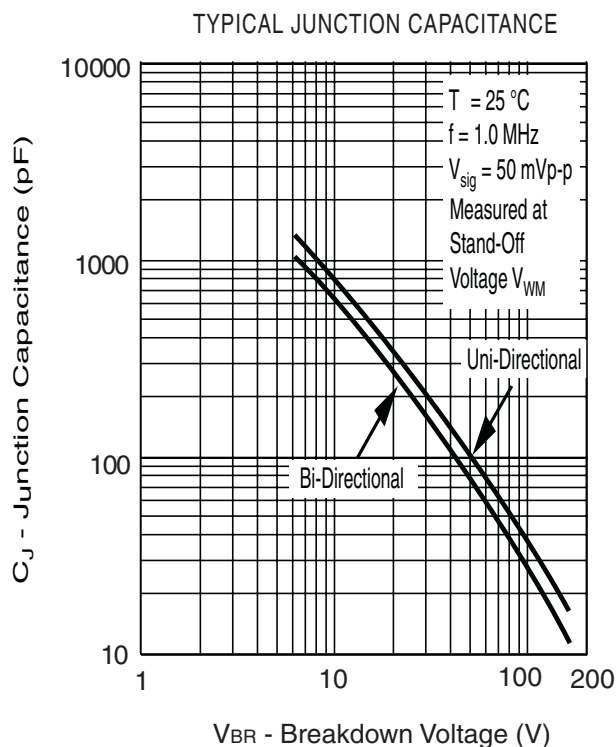
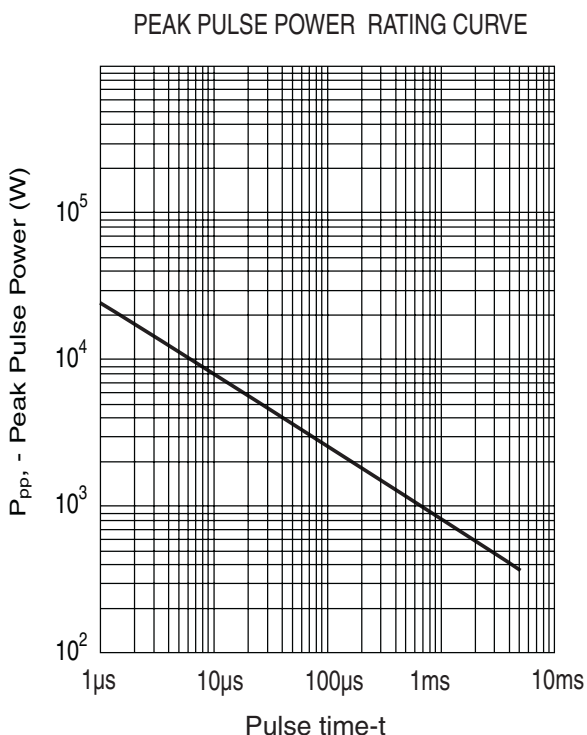
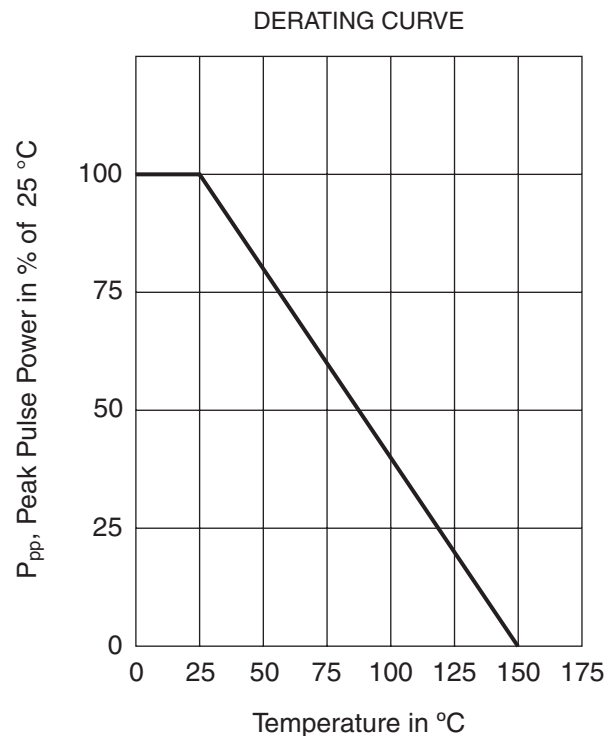
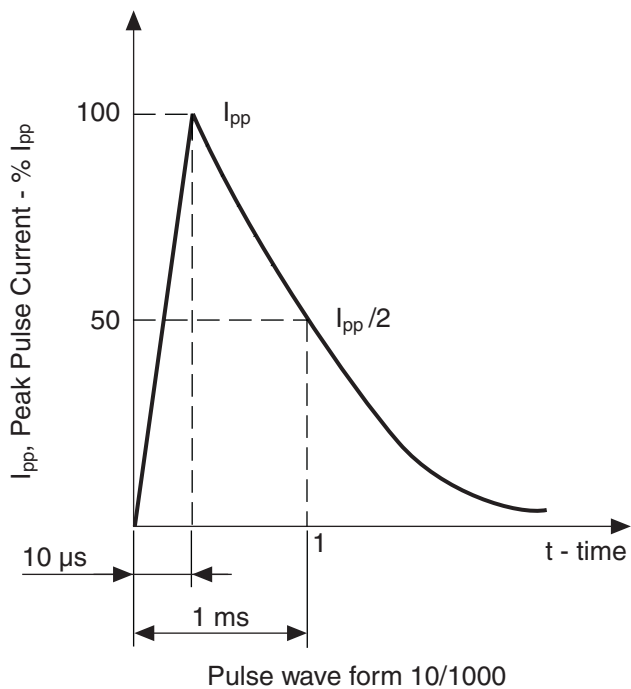

400 W Surface Mount Transient Voltage Suppressor

Revision History

| Date | Revision | Description of Changes |
|-------------|----------|--|
| 14-Sep-2012 | 0 | Original Data Sheet |
| 01-Mar-2013 | 1 | 480V to 540V Reference included for Unidirectional |
| 20-Jun-2013 | 2 | 350V Reference included for Unidirectional |

Disclaimer

All product, product specifications and data are subject to change without notice to improve reliability, function or design or otherwise.

Fagor Electrónica, S.Coop., its affiliates, agents, and employees, and all persons acting on its or their behalf (collectively, "Fagor"), disclaim any and all liability for any errors, inaccuracies or incompleteness contained in any datasheet or in any other disclosure relating to any product.

Fagor makes no warranty, representation or guarantee regarding the suitability of the products for any particular purpose or the continuing production of any product. To the maximum extent permitted by applicable law, Fagor disclaims (i) any and all liability arising out of the application or use of any product, (ii) any and all liability, including without limitation special, consequential or incidental damages, and (iii) any and all implied warranties, including warranties of fitness for particular purpose, non-infringement and merchantability.

Statements regarding the suitability of products for certain types of applications are based on Fagor's knowledge of typical requirements that are often placed on Fagor products in generic applications. Such statements are not binding statements about the suitability of products for a particular application. It is the customer's responsibility to validate that a particular product with the properties described in the product specification is suitable for use in a particular application. Parameters provided in datasheets and/or specifications may vary in different applications and performance may vary over time. All operating parameters, including typical parameters, must be validated for each customer application by the customer's technical experts. Product specifications do not expand or otherwise modify Fagor's terms and conditions of purchase, including but not limited to the warranty expressed therein.

Except as expressly indicated in writing, Fagor products are not designed for use in medical, life-saving, or life-sustaining applications or for any other application in which the failure of the Fagor product could result in personal injury or death. Customers using or selling Fagor products not expressly indicated for use in such applications do so at their own risk and agree to fully indemnify and hold Fagor and its distributors harmless from and against any and all claims, liabilities, expenses and damages arising or resulting in connection with such use or sale, including attorneys fees, even if such claim alleges that Fagor or its distributor was negligent regarding the design or manufacture of the part. Please contact authorized Fagor personnel to obtain written terms and conditions regarding products designed for such applications.

No license, express or implied, by estoppel or otherwise, to any intellectual property rights is granted by this document or by any conduct of Fagor, Product names and markings noted herein may be trademarks of their respective owners.