







400 W Surface Mount Transient Voltage Suppressor

<p>DO-214AC (SMA)</p> 	<table style="width: 100%; border: none;"> <tr> <td style="width: 50%; text-align: center;">Voltage</td> <td style="width: 50%; text-align: center;">Power</td> </tr> <tr> <td style="text-align: center;">6.8 V to 540 V (Uni) 6.8 V to 260 V (Bid)</td> <td style="text-align: center;">400 W /ms (300W above 250 V)</td> </tr> </table> <div style="text-align: center; margin-top: 10px;">  </div>	Voltage	Power	6.8 V to 540 V (Uni) 6.8 V to 260 V (Bid)	400 W /ms (300W above 250 V)
	Voltage	Power			
	6.8 V to 540 V (Uni) 6.8 V to 260 V (Bid)	400 W /ms (300W above 250 V)			
	<p>FEATURES</p> <ul style="list-style-type: none"> Low profile package Ideal for automated placement 400 W peak pulse power capability with a 10/1000 μs waveform, repetitive rate (duty cycle): 0.01 % Excellent clamping capability Very fast response time Low incremental surge resistance Available in uni-directional and bi-directional Solder dip 260°C, 10s AEC-Q101 qualified Component in accordance to RoHS 2011/65/EU and WEEE 2002/96/EC Meets MSL level 1, per J-STD-020, LF maximum peak of 260° C Halogen-free available according to IEC 61249-2-21 definition <div style="float: right; text-align: center;">    RoHS COMPLIANT  </div>				
<p>MECHANICAL DATA</p> <ul style="list-style-type: none"> Case: DO-214AC (SMA). Epoxy meets UL 94V-0 flammability rating. Polarity: For unidirectional types color band denotes cathode end. No marking on bidirectional types. Terminals: Matte tin plated leads, solderable per MIL-STD-750 Method 2026, J-STD-002 and JESD22-B102. Consumer grade, meets JESD 201 class 1A whisker test. HE3 suffix for high reliability grade, meets JESD 201 class 2 whisker test. 					
<p>TYPICAL APPLICATIONS</p> <p>Used in sensitive electronics protection against voltage transients induced by inductive load switching and lighting on ICs, MOSFET, signal lines of sensor units for consumer, computer, industrial, automotive and telecommunication.</p>					

Maximun Ratings and Electrical Characteristics at 25°C

P_{PPM}	Peak Pulse Power Dissipation with 10/1000 μ s exponential pulse (Note 3)	400 W, 300W
I_{FSM}	Peak Forward Surge Current 8.3 ms. (Note 1) (Jedec Method) (Note 2)	40 A
V_F	Max. forward voltage drop at $I_F = 25$ A (Note 1)	3.5 V
$T_J - T_{STG}$	Operating Junction and Storage Temperature Range	- 65 to + 150 °C

Notes: 1. Only for Unidirectional
 2. Mounted on 0.31 x 0.31" (8.0 x 8.0 mm) copper pads to each terminal
 3. Rating is 300W above 250V.

400 W Surface Mount Transient Voltage Suppressor

Ordering information

PREFERRED P/N	PACKAGE CODE	DELIVERY MODE	BASE QUANTITY	UNIT WEIGHT (g)
P4SMA33A TRTB	TRTB	13" diameter tape and reel	7,500	0.060
P4SMA33A TRTS	TRTS	7" diameter tape and reel	1,500	0.060
PSMA33A HE3 TRTB	TRTB	13" diameter tape and reel	7,500	0.060
P4SMA33A HE3 TRTS	TRTS	7" diameter tape and reel	1,500	0.060
P4MA33A HF TRTB	TRTB	13" diameter tape and reel	7,500	0.060
P4SMA33CA TRTB	TRTB	13" diameter tape and reel	7,500	0.060
P4SMA33CA TRTS	TRTS	7" diameter tape and reel	1,500	0.060
P4SMA33CA HE3 TRTB	TRTB	13" diameter tape and reel	7,500	0.060
P4SMA33CA HE3 TRTS	TRTS </td <td>7" diameter tape and reel</td> <td>1,500</td> <td>0.060</td>	7" diameter tape and reel	1,500	0.060
P4SMA33CA HF TRTB	TRTB	13" diameter tape and reel	7,500	0.060

Package Outline Dimensions: (mm) DO-214AC (SMA)

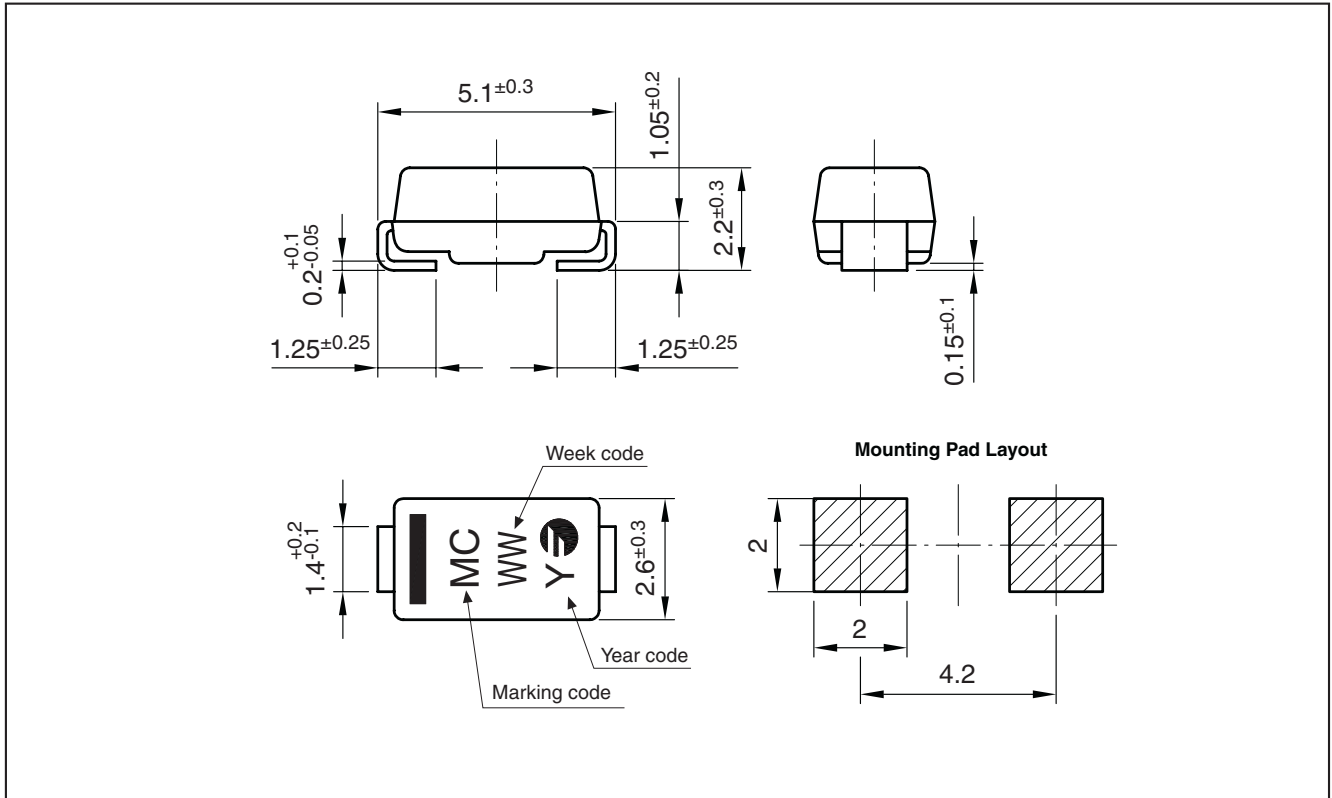

400 W Surface Mount Transient Voltage Suppressor

Type		Maximum Reverse Leakage Current		(1) Breakdown Voltage			I_R	Max. Clamping Voltage	
		I_{RM} at V_{RM}	V_{RM}	V_{BR} at V_{RM}	V_{BR} at V_{RM}	V_{BR} at V_{RM}		V_{CL} at I_{PP}	V_{CL} at I_{PP}
Unidirectional	Marking Code	(μ A)	(V)	Min.	Nom.	Max.	(mA)	(V)	(A)
P4SMA6V8	AD	1000	5.50	6.12	6.8	7.48	10	10.8	38
P4SMA6V8A	AE	1000	5.80	6.45	6.8	7.14	10	10.5	40
P4SMA7V5	AF	500	6.05	6.75	7.5	8.25	10	11.7	36
P4SMA7V5A	AG	500	6.40	7.13	7.5	7.88	10	11.3	37
P4SMA8V2	AH	200	6.63	7.38	8.2	9.02	10	12.5	33
P4SMA8V2A	AK	200	7.02	7.79	8.2	8.61	10	12.1	35
P4SMA9V1	AL	50	7.37	8.19	9.1	10.0	1	13.8	30
P4SMA9V1A	AM	50	7.78	8.65	9.1	9.55	1	13.4	31
P4SMA10	AN	10	8.10	9.00	10	11.0	1	15.0	28
P4SMA10A	AP	10	8.55	9.50	10	10.5	1	14.5	29
P4SMA11	AQ	5	8.92	9.90	11	12.1	1	16.2	26
P4SMA11A	AR	5	9.40	10.5	11	11.6	1	15.6	27
P4SMA12	AS	1	9.72	10.8	12	13.2	1	17.3	24
P4SMA12A	AT	1	10.2	11.4	12	12.6	1	16.7	25
P4SMA13	AU	1	10.5	11.7	13	14.3	1	19.0	22
P4SMA13A	AV	1	11.1	12.4	13	13.7	1	18.2	23
P4SMA15	AW	1	12.1	13.5	15	16.5	1	22.0	19
P4SMA15A	AX	1	12.8	14.3	15	15.8	1	21.2	20
P4SMA16	AY	1	12.9	14.4	16	17.6	1	23.5	18
P4SMA16A	AZ	1	13.6	15.2	16	16.8	1	22.5	19
P4SMA18	BD	1	14.5	16.2	18	19.8	1	26.5	16
P4SMA18A	BE	1	15.3	17.1	18	18.9	1	25.5	17
P4SMA20	BF	1	16.2	18.0	20	22.0	1	29.1	14
P4SMA20A	BG	1	17.1	19.0	20	21.0	1	27.7	15
P4SMA22	BH	1	17.8	19.8	22	24.2	1	31.9	13
P4SMA22A	BK	1	18.8	20.9	22	23.1	1	30.6	14
P4SMA24	BL	1	19.4	21.6	24	26.4	1	34.7	12
P4SMA24A	BM	1	20.5	22.8	24	25.2	1	33.2	13
P4SMA27	BN	1	21.8	24.3	27	29.7	1	39.1	11
P4SMA27A	BP	1	23.1	25.7	27	28.4	1	37.5	11.2
P4SMA30	BQ	1	24.3	27.0	30	33.0	1	43.5	10
P4SMA30A	BR	1	25.6	28.5	30	31.5	1	41.4	10
P4SMA33	BS	1	26.8	29.7	33	36.3	1	47.7	9
P4SMA33A	BT	1	28.2	31.4	33	34.7	1	45.7	9
P4SMA36	BU	1	29.1	32.4	36	39.6	1	52.0	8
P4SMA36A	BV	1	30.8	34.2	36	37.8	1	49.9	8.4
P4SMA39	BW	1	31.6	35.1	39	42.9	1	56.4	7.4
P4SMA39A	BX	1	33.3	37.1	39	41.0	1	53.9	7.8

(1) Tested with pulses.
Pulse test: $t_p \leq 50$ ms; $\delta < 2\%$

400 W Surface Mount Transient Voltage Suppressor

Type		Maximum Reverse Leakage Current I_{RM} at V_{RM}		(1) Breakdown Voltage V_{BR} at (V)			I_R	Max. Clamping Voltage V_{CL} at I_{PP} max. 1 ms. Expo.	
Unidirectional	Marking Code	(μ A)	(V)	Min.	Nom.	Max.	(mA)	(V)	(A)
P4SMA43	BY	1	34.8	38.7	43	47.3	1	61.9	6.8
P4SMA43A	BZ	1	36.8	40.9	43	45.2	1	59.3	7.1
P4SMA47	CD	1	38.1	42.3	47	51.7	1	67.8	6.2
P4SMA47A	CE	1	40.2	44.7	47	49.4	1	64.8	6.4
P4SMA51	CF	1	41.3	45.9	51	56.1	1	73.5	5.7
P4SMA51A	CG	1	43.6	48.5	51	53.6	1	70.1	6.0
P4SMA56	CH	1	45.4	50.4	56	61.6	1	80.5	5.2
P4SMA56A	CK	1	47.8	53.2	56	58.8	1	77.0	5.5
P4SMA62	CL	1	50.2	55.8	62	68.2	1	89.0	4.7
P4SMA62A	CM	1	53.0	58.9	62	65.1	1	85.0	5.0
P4SMA68	CN	1	55.1	61.2	68	74.8	1	98.0	4.3
P4SMA68A	CP	1	58.1	64.6	68	71.4	1	92.0	4.6
P4SMA75	CQ	1	60.7	67.5	75	82.5	1	108	3.9
P4SMA75A	CR	1	64.1	71.3	75	78.8	1	103	4.1
P4SMA82	CS	1	66.4	73.8	82	90.2	1	118	3.6
P4SMA82A	CT	1	70.1	77.9	82	86.1	1	113	3.7
P4SMA91	CU	1	73.7	81.9	91	100	1	131	3.2
P4SMA91A	CV	1	77.8	86.5	91	95.5	1	125	3.4
P4SMA100	CW	1	81.0	90.0	100	110	1	144	2.9
P4SMA100A	CX	1	85.5	95.0	100	105	1	137	3.1
P4SMA110	CY	1	89.2	99.0	110	121	1	158	2.7
P4SMA110A	CZ	1	94.0	105	110	116	1	152	2.8
P4SMA120	DD	1	97.2	108	120	132	1	173	2.4
P4SMA120A	DE	1	102	114	120	126	1	165	2.5
P4SMA130	DF	1	105	117	130	143	1	187	2.2
P4SMA130A	DG	1	111	124	130	137	1	179	2.3
P4SMA150	DH	1	121	135	150	165	1	215	2.0
P4SMA150A	DL	1	128	143	150	158	1	207	2.0
P4SMA160	DM	1	130	144	160	176	1	230	1.8
P4SMA160A	DN	1	136	152	160	168	1	219	1.9
P4SMA170	DP	1	138	153	170	187	1	244	1.7
P4SMA170A	DQ	1	145	162	170	179	1	234	1.8
P4SMA180	DR	1	146	162	180	198	1	258	1.6
P4SMA180A	DS	1	154	171	180	189	1	246	1.7
P4SMA200	DT	1	162	180	200	220	1	287	1.5
P4SMA200A	DU	1	171	190	200	210	1	274	1.53
P4SMA220	DV	1	175	198	220	242	1	344	1.16
P4SMA220A	DX	1	185	209	220	231	1	328	1.22
P4SMA250A	DW	1	214	237	250	263	1	344	0.91
P4SMA300A	DY	1	256	285	300	315	1	414	0.73
P4SMA350A	DZ	1	300	333	350	368	1	482	0.62
P4SMA400A	DJ	1	342	380	400	420	1	548	0.55
P4SMA440A	DK	1	376	418	440	462	1	602	0.5
P4SMA480A	WJ	1	408	456	480	504	1	658	0.46
P4SMA510A	WL	1	434	485	510	535	1	698	0.43
P4SMA540A	WN	1	459	513	540	567	1	740	0.41

(1) Tested with pulses.
Pulse test: $t_p \leq 50$ ms; $\delta < 2\%$

400 W Surface Mount Transient Voltage Suppressor

Type		Maximum Reverse Leakage Current I_{RM} at V_{RM}		(1) Breakdown Voltage V_{BR} at I_R				Max. Clamping Voltage V_{CL} at I_{pp} max. 1ms. Expo.	
Bidirectional	Marking Code	(μA)	(V)	Min.	Nom.	Max.	(mA)	(V)	(A)
P4SMA6V8C	RA	1000	5.50	6.12	6.8	7.48	10	10.8	38
P4SMA6V8CA	RB	1000	5.80	6.45	6.8	7.14	10	10.5	38.1
P4SMA7V5C	RC	500	6.05	6.75	7.5	8.25	10	11.7	36
P4SMA7V5CA	RD	500	6.40	7.13	7.5	7.88	10	11.3	35.4
P4SMA8V2C	RE	200	6.63	7.38	8.2	9.02	10	12.5	33
P4SMA8V2CA	RF	200	7.02	7.79	8.2	8.61	10	12.1	33.1
P4SMA9V1C	RG	50	7.37	8.19	9.1	10.0	1	13.8	30
P4SMA9V1CA	RH	50	7.78	8.65	9.1	9.55	1	13.4	29.9
P4SMA10C	RI	10	8.10	9.00	10	11.0	1	15.0	28
P4SMA10CA	RJ	10	8.55	9.50	10	10.5	1	14.5	27.6
P4SMA11C	RK	5	8.92	9.90	11	12.1	1	16.2	26
P4SMA11CA	RL	5	9.40	10.5	11	11.6	1	15.6	25.6
P4SMA12C	RM	1	9.72	10.8	12	13.2	1	17.3	24
P4SMA12CA	RN	1	10.2	11.4	12	12.6	1	16.7	24
P4SMA13C	RO	1	10.5	11.7	13	14.3	1	19.0	22
P4SMA13CA	RP	1	11.1	12.4	13	13.7	1	18.2	22
P4SMA15C	RR	1	12.1	13.5	15	16.5	1	22.0	19
P4SMA15CA	RS	1	12.8	14.3	15	15.8	1	21.2	18.9
P4SMA16C	RT	1	12.9	14.4	16	17.6	1	23.5	18
P4SMA16CA	RU	1	13.6	15.2	16	16.8	1	22.5	17.8
P4SMA18C	RV	1	14.5	16.2	18	19.8	1	26.5	16
P4SMA18CA	CC	1	15.3	17.1	18	18.9	1	25.5	17
P4SMA20C	RX	1	16.2	18.0	20	22.0	1	29.1	14
P4SMA20CA	RY	1	17.1	19.0	20	21.0	1	27.7	14.4
P4SMA22C	RZ	1	17.8	19.8	22	24.2	1	31.9	13
P4SMA22CA	SA	1	18.8	20.9	22	23.1	1	30.6	13.1
P4SMA24C	SB	1	19.4	21.6	24	26.4	1	34.7	12
P4SMA24CA	SC	1	20.5	22.8	24	25.2	1	33.2	12
P4SMA27C	SD	1	21.8	24.3	27	29.7	1	39.1	11
P4SMA27CA	SE	1	23.1	25.7	27	28.4	1	37.5	10.9
P4SMA30C	SF	1	24.3	27.0	30	33.0	1	43.5	10
P4SMA30CA	SG	1	25.6	28.5	30	31.5	1	41.4	9.7
P4SMA33C	SH	1	26.8	29.7	33	36.3	1	47.7	9
P4SMA33CA	SI	1	28.2	31.4	33	34.7	1	45.7	9
P4SMA36C	SJ	1	29.1	32.4	36	39.6	1	52.0	8
P4SMA36CA	SK	1	30.8	34.2	36	37.8	1	49.9	8
P4SMA39C	SL	1	31.6	35.1	39	42.9	1	56.4	7.4
P4SMA39CA	SM	1	33.3	37.1	39	41.0	1	53.9	7.4

(1) Tested with pulses.
Pulse test: $t_p \leq 50$ ms; $\delta < 2\%$

400 W Surface Mount Transient Voltage Suppressor

Type		Maximum Reverse Leakage Current I_{RM} at V_{RM}		(1) Breakdown Voltage V_{BR} at I_R (V)				Max. Clamping Voltage V_{CL} at I_{pp} max. 1ms. Expo.	
Bidirectional	Marking Code	(μA)	(V)	Min.	Nom.	Max.	(mA)	(V)	(A)
P4SMA43C	SN	1	34.8	38.7	43	47.3	1	61.9	6.8
P4SMA43CA	SO	1	36.8	40.9	43	45.2	1	59.3	6.7
P4SMA47C	SP	1	38.1	42.3	47	51.7	1	67.8	6.2
P4SMA47CA	SR	1	40.2	44.7	47	49.4	1	64.8	6.2
P4SMA51C	SS	1	41.3	45.9	51	56.1	1	73.5	5.7
P4SMA51CA	CA	1	43.6	48.5	51	53.6	1	70.1	5.7
P4SMA56C	ST	1	45.4	50.4	56	61.6	1	80.5	5.2
P4SMA56CA	CB	1	47.8	53.2	56	58.8	1	77.0	5.2
P4SMA62C	SU	1	50.2	55.8	62	68.2	1	89.0	4.7
P4SMA62CA	CI	1	53.0	58.9	62	65.1	1	85.0	4.7
P4SMA68C	SW	1	55.1	61.2	68	74.8	1	98.0	4.3
P4SMA68CA	UY	1	58.1	64.6	68	71.4	1	92.0	4.3
P4SMA75C	SY	1	60.7	67.5	75	82.5	1	108	3.9
P4SMA75CA	SZ	1	64.1	71.3	75	78.8	1	103	3.9
P4SMA82C	WA	1	66.4	73.8	82	90.2	1	118	3.6
P4SMA82CA	PB	1	70.1	77.9	82	86.1	1	113	3.5
P4SMA91C	WC	1	73.7	81.9	91	100	1	131	3.2
P4SMA91CA	PC	1	77.8	86.5	91	95.5	1	125	3.2
P4SMA100C	WE	1	81.0	90.00	100	110	1	144	2.9
P4SMA100CA	CJ	1	85.5	95.0	100	105	1	137	2.9
P4SMA110C	WG	1	89.2	99.0	110	121	1	158	2.7
P4SMA110CA	PJ	1	94.0	105	110	116	1	152	2.0
P4SMA120C	WI	1	97.2	108	120	132	1	173	2.4
P4SMA120CA	PO	1	102	114	120	126	1	165	1.8
P4SMA130C	WK	1	105	117	130	143	1	187	2.2
P4SMA130CA	NA	1	111	124	130	137	1	179	1.7
P4SMA150C	WM	1	121	135	150	165	1	215	2.0
P4SMA150CA	NB	1	128	143	150	158	1	207	1.4
P4SMA160C	WO	1	130	144	160	176	1	230	1.8
P4SMA160CA	NC	1	136	152	160	168	1	219	1.4
P4SMA170C	WR	1	138	153	170	187	1	244	1.7
P4SMA170CA	NI	1	145	162	170	179	1	234	1.3
P4SMA180C	WT	1	146	162	180	198	1	258	1.6
P4SMA180CA	NO	1	154	171	180	189	1	246	1.2
P4SMA200C	WV	1	162	180	200	220	1	287	1.5
P4SMA200CA	MA	1	171	190	200	210	1	274	1.45
P4SMA220C	WX	1	175	198	220	242	1	344	1.16
P4SMA220CA	MB	1	185	209	220	231	1	328	1.21
P4SMA250C	MI	1	202	225	250	275	1	360	1.11
P4SMA250CA	MJ	1	214	237	250	263	1	344	1.16
P4SMA260CA	MO	1	232	247	260	273	1	360	1.11

(1) Tested with pulses.
Pulse test: $t_p \leq 50$ ms; $\delta < 2\%$

400 W Surface Mount Transient Voltage Suppressor

Ratings and Characteristics (Ta 25 °C unless otherwise noted)

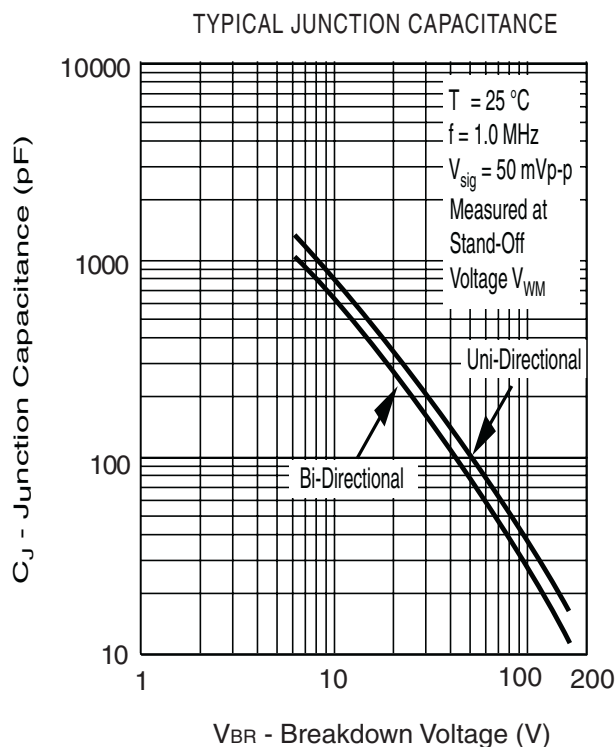
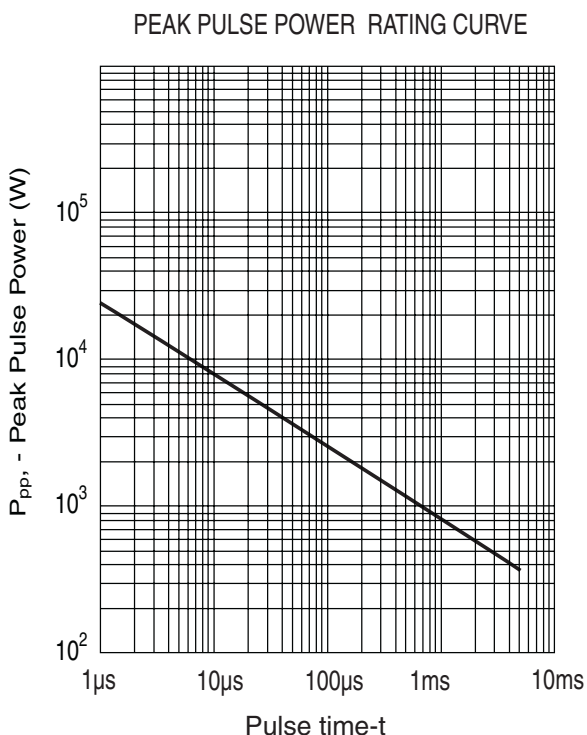
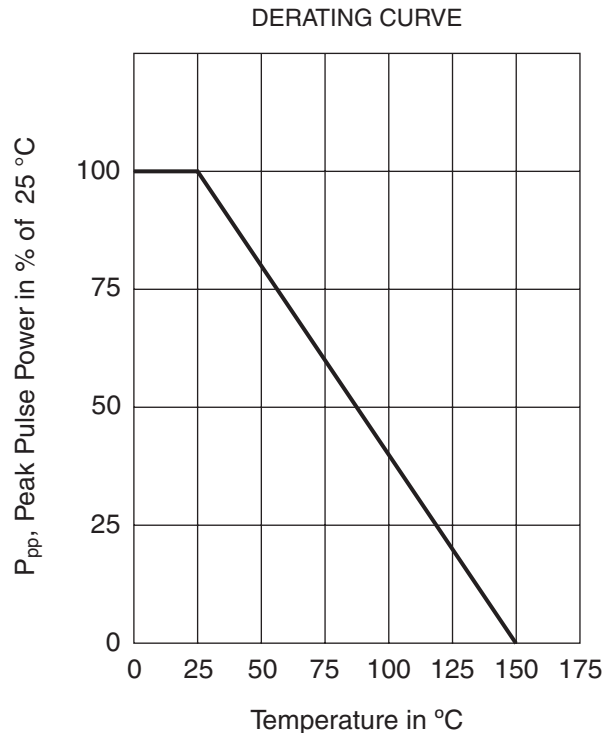
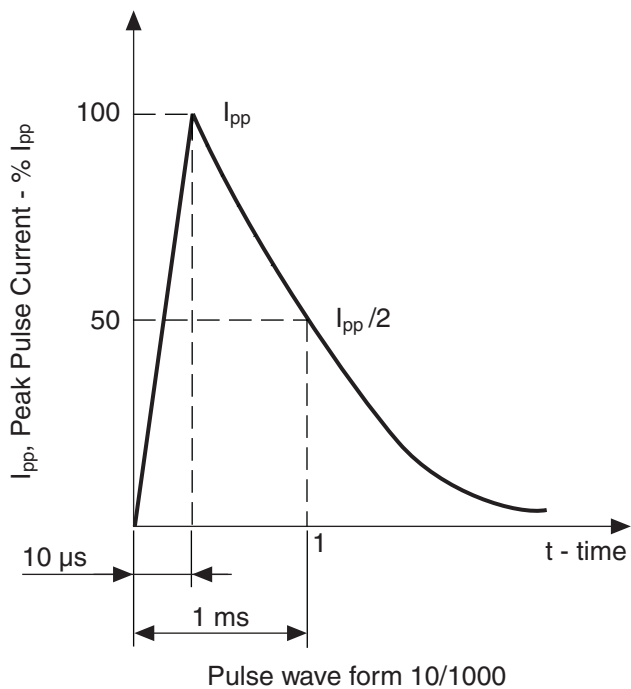

400 W Surface Mount Transient Voltage Suppressor**Revision History**

Date	Revision	Description of Changes
14-Sep-2012	0	Original Data Sheet
01-Mar-2013	1	480V to 540V Reference included for Unidirectional
20-Jun-2013	2	350V Reference included for Unidirectional

Disclaimer

All product, product specifications and data are subject to change without notice to improve reliability, function or design or otherwise.

Fagor Electrónica, S.Coop., its affiliates, agents, and employees, and all persons acting on its or their behalf (collectively, "Fagor"), disclaim any and all liability for any errors, inaccuracies or incompleteness contained in any datasheet or in any other disclosure relating to any product.

Fagor makes no warranty, representation or guarantee regarding the suitability of the products for any particular purpose or the continuing production of any product. To the maximum extent permitted by applicable law, Fagor disclaims (i) any and all liability arising out of the application or use of any product, (ii) any and all liability, including without limitation special, consequential or incidental damages, and (iii) any and all implied warranties, including warranties of fitness for particular purpose, non-infringement and merchantability.

Statements regarding the suitability of products for certain types of applications are based on Fagor's knowledge of typical requirements that are often placed on Fagor products in generic applications. Such statements are not binding statements about the suitability of products for a particular application. It is the customer's responsibility to validate that a particular product with the properties described in the product specification is suitable for use in a particular application. Parameters provided in datasheets and/or specifications may vary in different applications and performance may vary over time. All operating parameters, including typical parameters, must be validated for each customer application by the customer's technical experts. Product specifications do not expand or otherwise modify Fagor's terms and conditions of purchase, including but not limited to the warranty expressed therein.

Except as expressly indicated in writing, Fagor products are not designed for use in medical, life-saving, or life-sustaining applications or for any other application in which the failure of the Fagor product could result in personal injury or death. Customers using or selling Fagor products not expressly indicated for use in such applications do so at their own risk and agree to fully indemnify and hold Fagor and its distributors harmless from and against any and all claims, liabilities, expenses and damages arising or resulting in connection with such use or sale, including attorneys fees, even if such claim alleges that Fagor or its distributor was negligent regarding the design or manufacture of the part. Please contact authorized Fagor personnel to obtain written terms and conditions regarding products designed for such applications.

No license, express or implied, by estoppel or otherwise, to any intellectual property rights is granted by this document or by any conduct of Fagor, Product names and markings noted herein may be trademarks of their respective owners.