



SEMIPACK[®] 5

Rectifier Diode Modules

SKKD 700

Features

- Heat transfer through aluminium nitride ceramic isolated metal baseplate
- Precise metal pressure contacts for high reliability
- UL recognized, file no. E 63 532

Typical Applications

- Uncontrolled rectifiers for AC/AC converters
- Line rectifiers for transistorized AC motor controllers

1) The screws must be lubricated

V_{RSM} V	V_{RRM} V	$I_{FRMS} = 1100$ A (maximum value for continuous operation) $I_{FAV} = 700$ A (sin. 180; $T_c = 100$ °C)	
900	800	SKKD 700/08	
1300	1200	SKKD 700/12	
1500	1400	SKKD 700/14	
1700	1600	SKKD 700/16	
1900	1800	SKKD 700/18	
2100	2000	SKKD 700/20 H4	
2300	2200	SKKD 700/22 H4	

Symbol	Conditions	Values	Units
I_{FAV}	sin. 180; $T_c = 100$ °C	700	A
I_{FSM}	$T_{vj} = 25$ °C; 10 ms	25000	A
	$T_{vj} = 125$ °C; 10 ms	22000	A
i^2t	$T_{vj} = 25$ °C; 8,3 ... 10 ms	3125000	A ² s
	$T_{vj} = 125$ °C; 8,3 ... 10 ms	2420000	A ² s
V_F	$T_{vj} = 25$ °C; $I_F = 2000$ A	max. 1,3	V
$V_{(TO)}$	$T_{vj} = 150$ °C	max. 0,75	V
r_T	$T_{vj} = 150$ °C	max. 0,2	mΩ
I_{RD}	$T_{vj} = 150$ °C; $V_{RD} = V_{RRM}$	max. 20	mA
$R_{th(j-c)}$	cont.; per diode / per module	0,062 / 0,031	K/W
	sin. 180; per diode / per module	0,065 / 0,0325	K/W
	rec. 120; per diode / per module	0,07 / 0,035	K/W
$R_{th(c-s)}$	per diode / per module	0,02 / 0,01	K/W
T_{vj}		- 40 ... + 150	°C
T_{stg}		- 40 ... + 130	°C
V_{isol}	a. c. 50 Hz; r.m.s.; 1 s / 1 min.	3600 / 3000	V~
V_{isol}	a. c. 50 Hz; r.m.s.; 1 s / 1 min. for SKKD ...H4	4800 / 4000	V~
M_s	to heatsink	5 ± 15 %	Nm
M_t	to terminals	12 ± 15 % ¹⁾	Nm
a		5 * 9,81	m/s ²
m		1420	g
Case		A 75a	

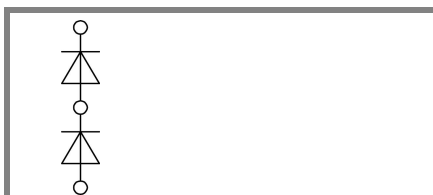

SKKD

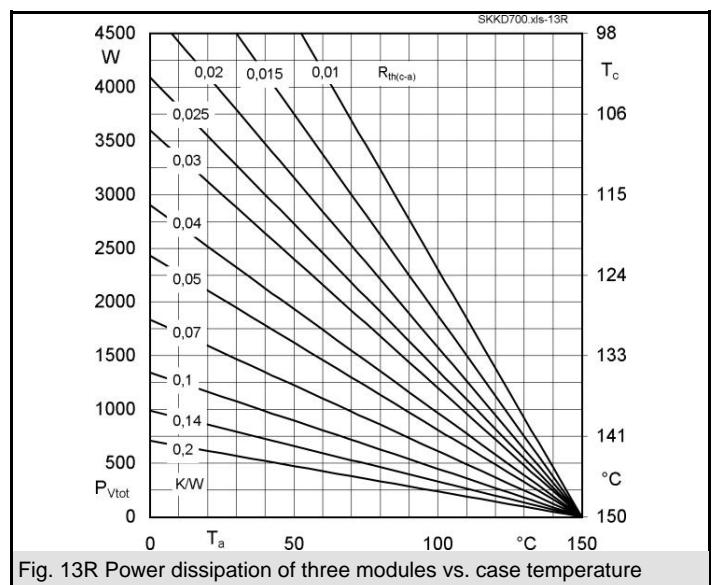
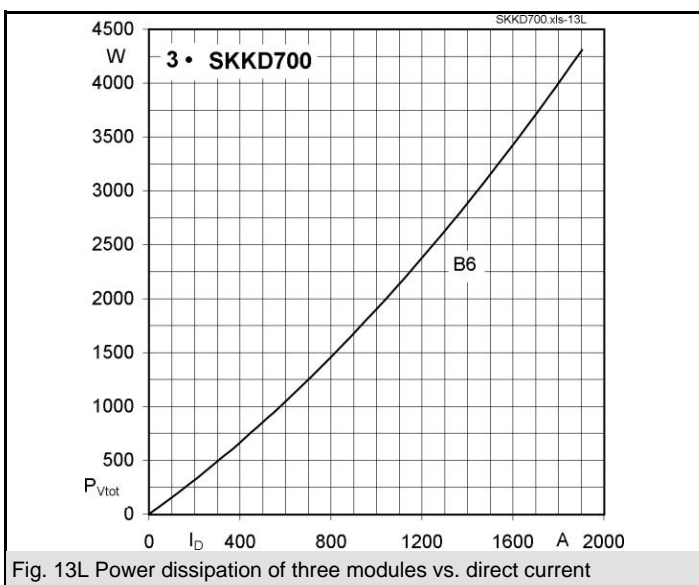
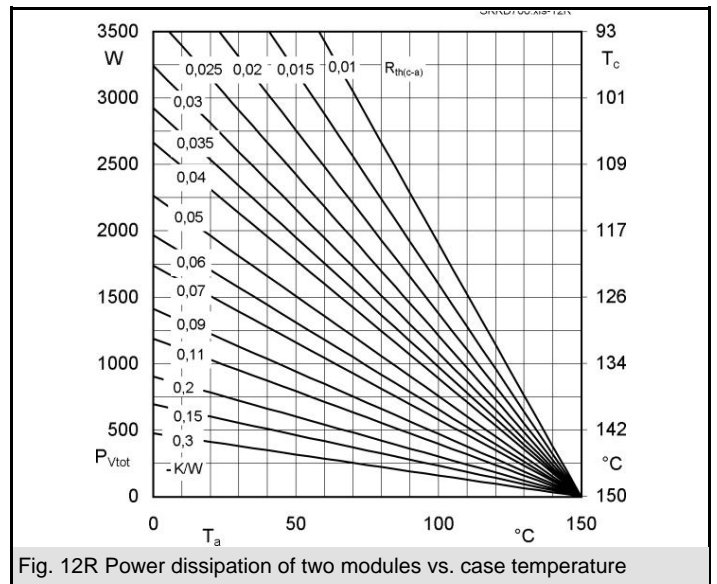
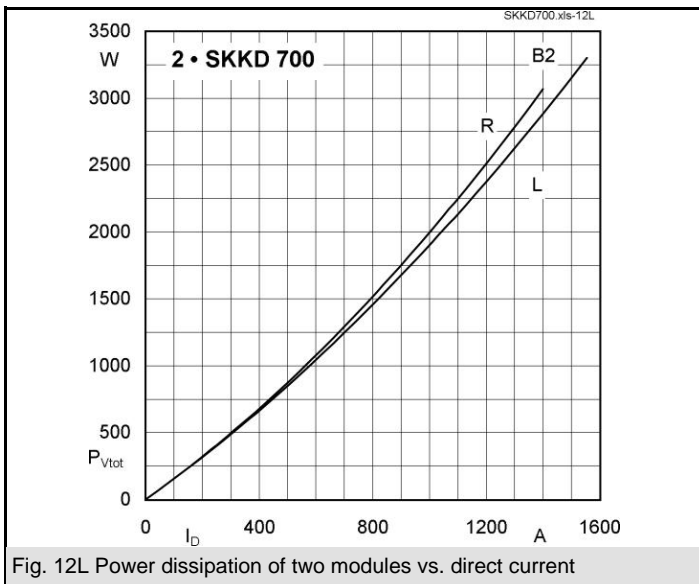
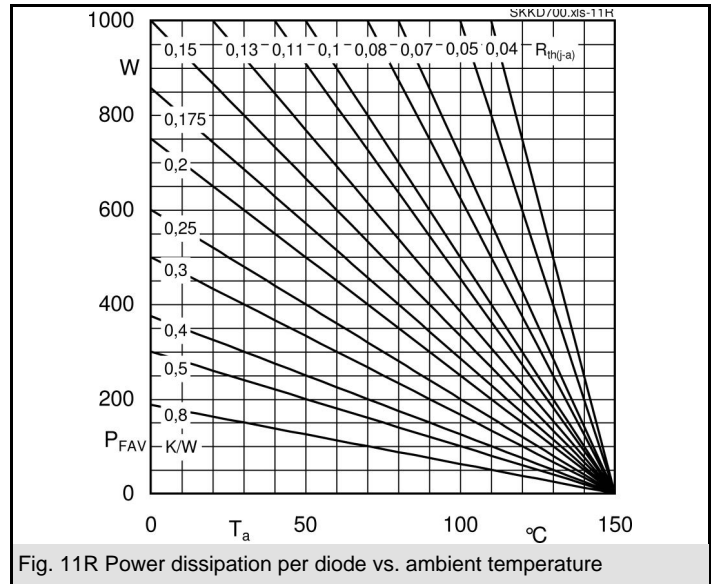
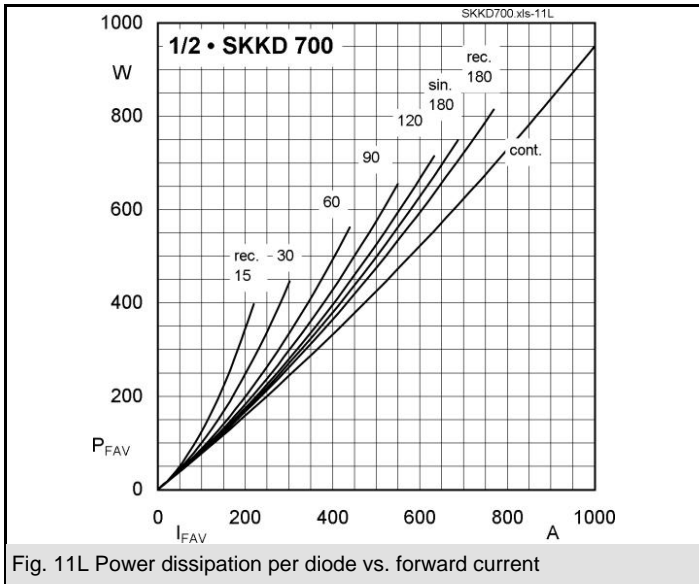

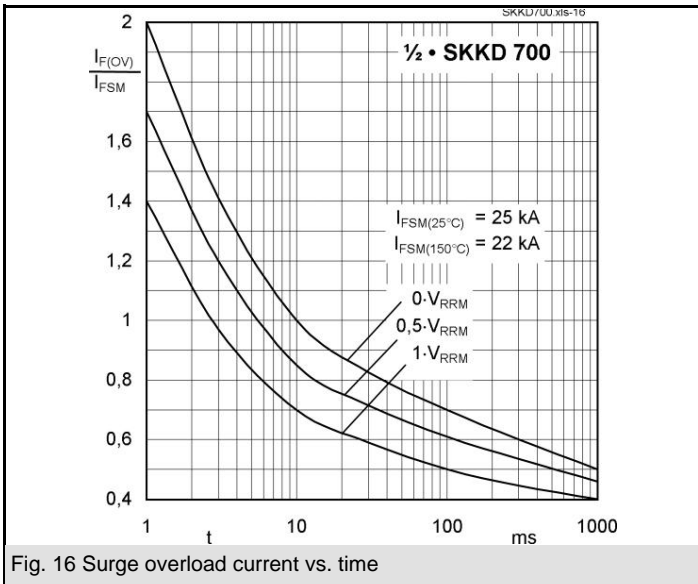
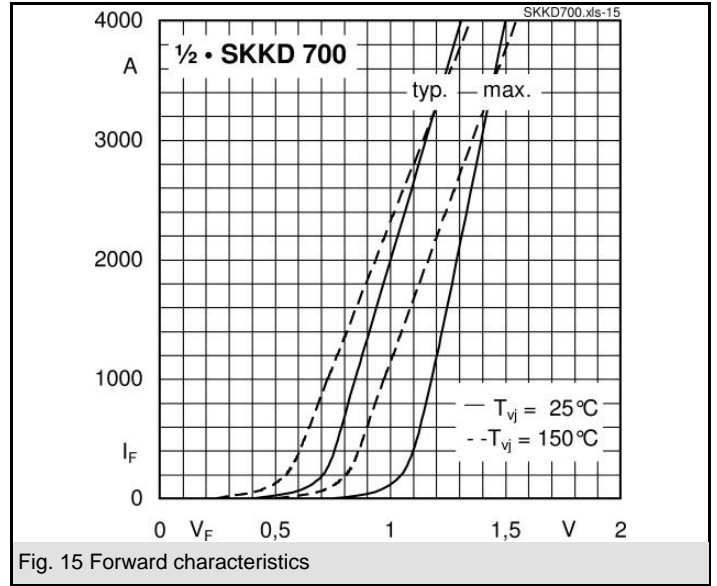
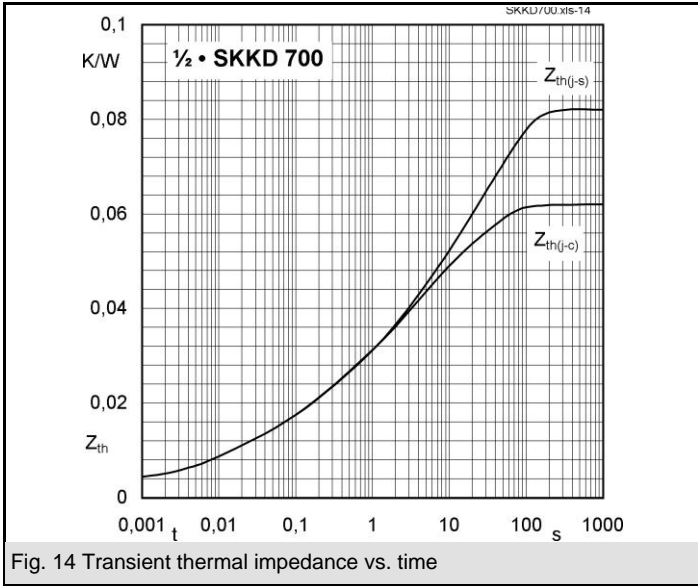

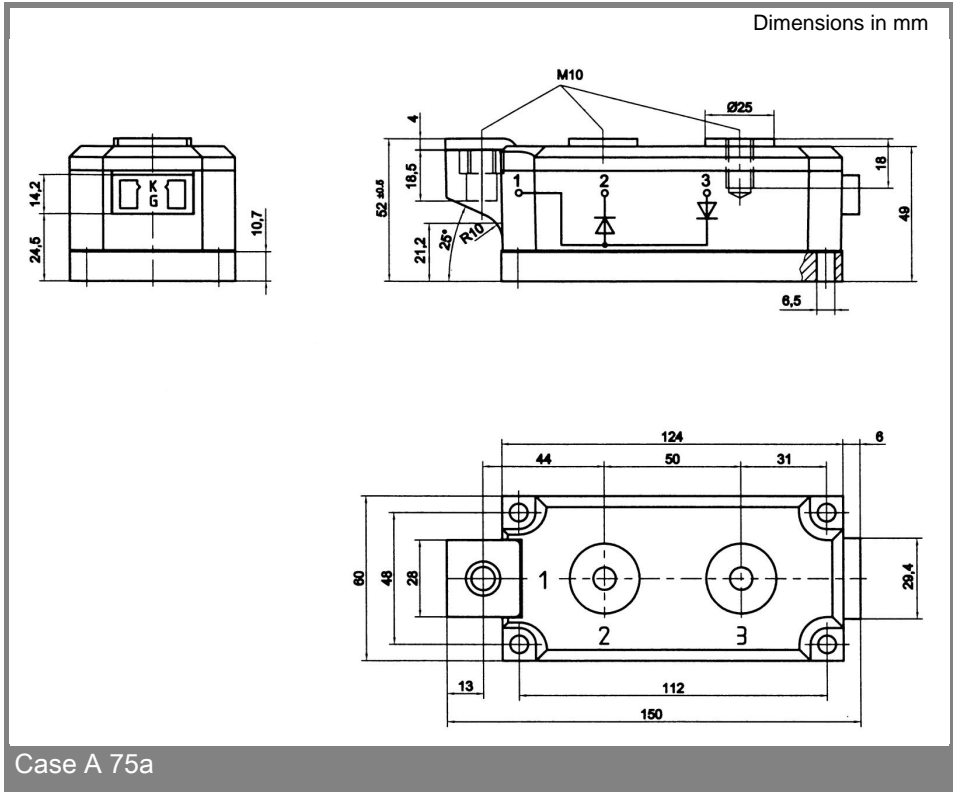

This technical information specifies semiconductor devices but promises no characteristics. No warranty or guarantee expressed or implied is made regarding delivery, performance or suitability.