

P6SMB6.8A  
THRU  
P6SMB250A



**SURFACE MOUNT  
UNI-DIRECTIONAL  
GLASS PASSIVATED JUNCTION  
SILICON TRANSIENT  
VOLTAGE SUPPRESSOR  
600 WATTS, 6.8 THRU 250 VOLTS**



www.centrasemi.com

**DESCRIPTION:**

The CENTRAL SEMICONDUCTOR P6SMB6.8A Series types are Surface Mount Uni-Directional Glass Passivated Junction Transient Voltage Suppressors designed to protect voltage sensitive components from high voltage transients.

**THIS DEVICE IS MANUFACTURED WITH A GLASS PASSIVATED CHIP FOR OPTIMUM RELIABILITY.**

Note: For Bi-directional devices, please refer to the P6SMB6.8CA Series data sheet.

**MARKING CODE: SEE ELECTRICAL CHARACTERISTICS TABLE**

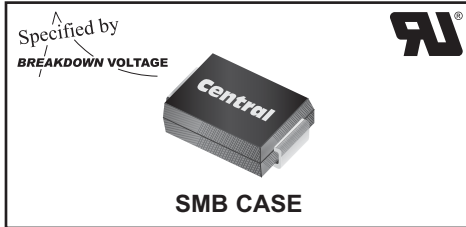

• This series is UL listed, UL file number E130224

MAXIMUM RATINGS: ( $T_A=25^\circ\text{C}$ unless otherwise noted)	SYMBOL	UNITS
Peak Power Dissipation (Note 1)	$P_{DM}$	600 W
Peak Forward Surge Current (JEDEC Method)	$I_{FSM}$	100 A
Operating and Storage Junction Temperature	$T_J, T_{stg}$	-65 to +150 $^\circ\text{C}$

**ELECTRICAL CHARACTERISTICS: ( $T_A=25^\circ\text{C}$  unless otherwise noted)**

TYPE	BREAKDOWN VOLTAGE $V_{BR} @ I_T$			TEST CURRENT $I_T$ (mA)	WORKING PEAK REVERSE VOLTAGE $V_{RWM}$ (V)	MAXIMUM REVERSE LEAKAGE CURRENT @ $V_{RWM}$ $I_R$ ( $\mu\text{A}$ )	MAXIMUM REVERSE SURGE CURRENT (Note 1) $I_{RSM}$ (A)	MAXIMUM REVERSE VOLTAGE @ $I_{RSM}$ $V_{RSM}$ (V)	MAXIMUM TEMPERATURE COEFFICIENT $\theta_{V_{BR}}$ (% / $^\circ\text{C}$ )	MARKING CODE
	MIN (V)	NOM (V)	MAX (V)							
P6SMB6.8A	6.45	6.8	7.14	10	5.8	1000	57	10.5	0.057	C6V8A
P6SMB7.5A	7.13	7.5	7.88	10	6.4	500	53	11.3	0.061	C7V5A
P6SMB8.2A	7.79	8.2	8.61	10	7.02	200	50	12.1	0.065	C8V2A
P6SMB9.1A	8.65	9.1	9.55	1.0	7.78	50	45	13.4	0.068	C9V1A
P6SMB10A	9.5	10	10.5	1.0	8.55	10	41	14.5	0.073	C10A
P6SMB11A	10.5	11	11.6	1.0	9.4	5.0	38	15.6	0.075	C11A
P6SMB12A	11.4	12	12.6	1.0	10.2	5.0	36	16.7	0.078	C12A
P6SMB13A	12.4	13	13.7	1.0	11.1	5.0	33	18.2	0.081	C13A
P6SMB15A	14.3	15	15.8	1.0	12.8	5.0	28	21.2	0.084	C15A
P6SMB16A	15.2	16	16.8	1.0	13.6	5.0	27	22.5	0.086	C16A
P6SMB18A	17.1	18	18.9	1.0	15.3	5.0	24	25.2	0.088	C18A
P6SMB20A	19	20	21	1.0	17.1	5.0	22	27.7	0.090	C20A
P6SMB22A	20.9	22	23.1	1.0	18.8	5.0	20	30.6	0.092	C22A
P6SMB24A	22.8	24	25.2	1.0	20.5	5.0	18	33.2	0.094	C24A
P6SMB27A	25.7	27	28.4	1.0	23.1	5.0	16	37.5	0.096	C27A
P6SMB30A	28.5	30	31.5	1.0	25.6	5.0	14.4	41.4	0.097	C30A
P6SMB33A	31.4	33	34.7	1.0	28.2	5.0	13.2	45.7	0.098	C33A
P6SMB36A	34.2	36	37.8	1.0	30.8	5.0	12	49.9	0.099	C36A
P6SMB39A	37.1	39	41	1.0	33.3	5.0	11.2	53.9	0.100	C39A

Notes: (1) Non-repetitive 10x1,000 $\mu\text{s}$  pulse.

R5 (1-March 2010)

**P6SMB6.8A  
THRU  
P6SMB250A**

**SURFACE MOUNT  
UNI-DIRECTIONAL  
GLASS PASSIVATED JUNCTION  
SILICON TRANSIENT  
VOLTAGE SUPPRESSOR  
600 WATTS, 6.8 THRU 250 VOLTS**



**ELECTRICAL CHARACTERISTICS - Continued:** ( $T_A=25^\circ\text{C}$  unless otherwise noted)

TYPE	BREAKDOWN VOLTAGE $V_{BR} @ I_T$			TEST CURRENT	WORKING PEAK REVERSE VOLTAGE	MAXIMUM REVERSE LEAKAGE CURRENT @ $V_{RWM}$	MAXIMUM REVERSE SURGE CURRENT (Note 1)	MAXIMUM REVERSE VOLTAGE @ $I_{RSM}$	MAXIMUM TEMPERATURE COEFFICIENT	MARKING CODE
	MIN (V)	NOM (V)	MAX (V)	$I_T$ (mA)	$V_{RWM}$ (V)	$I_R$ ( $\mu\text{A}$ )	$I_{RSM}$ (A)	$V_{RSM}$ (V)	$\frac{\partial V_{BR}}{\partial T}$ (% / $^\circ\text{C}$ )	
P6SMB43A	40.9	43	45.2	1.0	36.8	5.0	10.1	59.3	0.101	C43A
P6SMB47A	44.7	47	49.4	1.0	40.2	5.0	9.3	64.8	0.101	C47A
P6SMB51A	48.5	51	53.6	1.0	43.6	5.0	8.6	70.1	0.102	C51A
P6SMB56A	53.2	56	58.8	1.0	47.8	5.0	7.8	77	0.103	C56A
P6SMB62A	58.9	62	65.1	1.0	53	5.0	7.1	85	0.104	C62A
P6SMB68A	64.6	68	71.4	1.0	58.1	5.0	6.5	92	0.104	C68A
P6SMB75A	71.3	75	78.8	1.0	64.1	5.0	5.8	103	0.105	C75A
P6SMB82A	77.9	82	86.1	1.0	70.1	5.0	5.3	113	0.105	C82A
P6SMB91A	86.5	91	95.5	1.0	77.8	5.0	4.8	125	0.106	C91A
P6SMB100A	95	100	105	1.0	85.5	5.0	4.4	137	0.106	C100A
P6SMB110A	104.5	110	115.5	1.0	94.0	5.0	4.0	152	0.107	C110A
P6SMB120A	114	120	126	1.0	102	5.0	3.6	165	0.107	C120A
P6SMB130A	123.5	130	136.5	1.0	111	5.0	3.3	179	0.107	C130A
P6SMB150A	142.5	150	157.5	1.0	128	5.0	2.9	207	0.108	C150A
P6SMB160A	152	160	168	1.0	136	5.0	2.7	219	0.108	C160A
P6SMB170A	161.5	170	178.5	1.0	145	5.0	2.6	234	0.108	C170A
P6SMB180A	171	180	189	1.0	154	5.0	2.4	246	0.108	C180A
P6SMB200A	190	200	210	1.0	171	5.0	2.2	274	0.108	C200A
P6SMB220A	209	220	231	1.0	185	5.0	1.8	328	0.108	C220A
P6SMB250A	237.5	250	262.5	1.0	214	5.0	1.7	344	0.110	C250A

**SMB CASE - MECHANICAL OUTLINE**

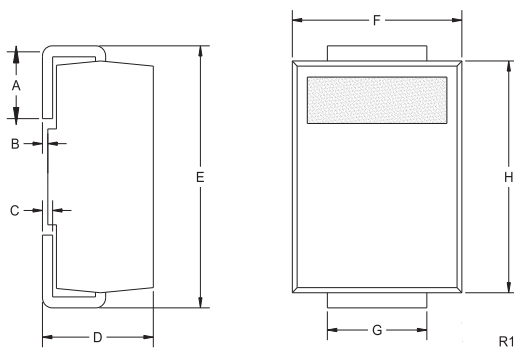

SYMBOL	DIMENSIONS			
	INCHES		MILLIMETERS	
	MIN	MAX	MIN	MAX
A	0.030	0.060	0.76	1.52
B	0.004	0.008	0.10	0.20
C	0.006	0.012	0.15	0.30
D	0.086	0.096	2.18	2.44
E	0.200	0.220	5.08	5.59
F	0.130	0.150	3.30	3.81
G	0.077	0.083	1.96	2.11
H	0.160	0.180	4.06	4.57

SMB (REV: R1)

R5 (1-March 2010)

**P6SMB6.8A  
THRU  
P6SMB250A**

**SURFACE MOUNT  
UNI-DIRECTIONAL  
GLASS PASSIVATED JUNCTION  
SILICON TRANSIENT  
VOLTAGE SUPPRESSOR  
600 WATTS, 6.8 THRU 250 VOLTS**



### TYPICAL ELECTRICAL CHARACTERISTICS

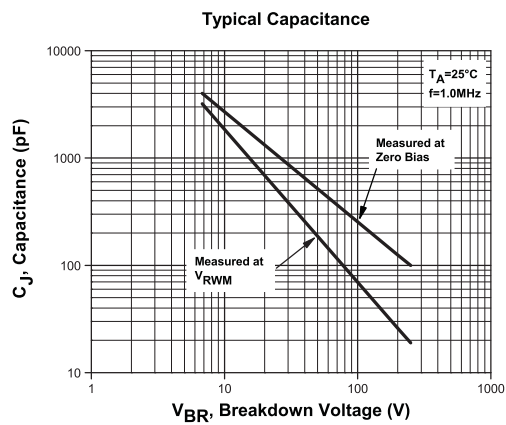
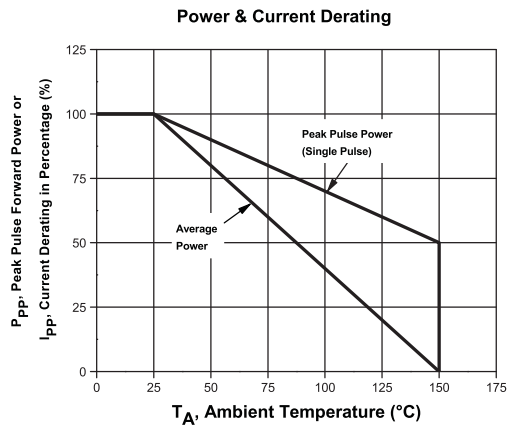
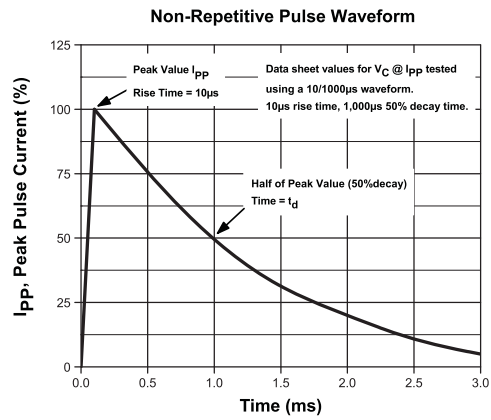
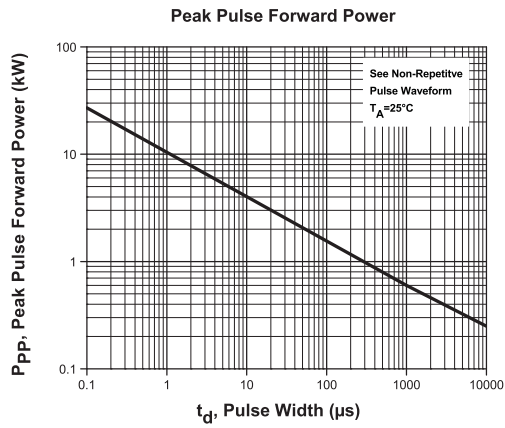

R5 (1-March 2010)