

Features

- Glass Passivated Die Construction
- Low Forward Voltage Drop
- High Current Capability
- High Reliability
- High Surge Current Capability

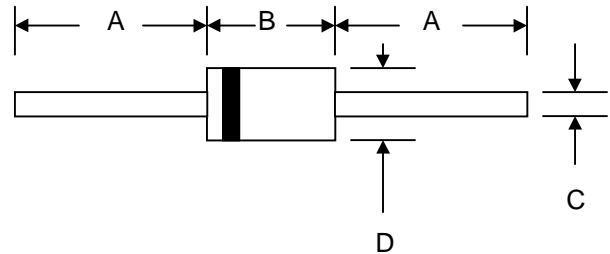

Mechanical Data

- Case: DO-41, Molded Plastic
- Terminals: Plated Leads Solderable per MIL-STD-202, Method 208
- Polarity: Cathode Band
- Weight: 0.34 grams (approx.)
- Mounting Position: Any
- Marking: Type Number
- **Lead Free: For RoHS / Lead Free Version, Add "-LF" Suffix to Part Number, See Page 4**

DO-41		
Dim	Min	Max
A	25.4	—
B	4.06	5.21
C	0.71	0.864
D	2.00	2.72
All Dimensions in mm		

Maximum Ratings and Electrical Characteristics @ $T_A=25^\circ\text{C}$ unless otherwise specified

Single Phase, half wave, 60Hz, resistive or inductive load.
For capacitive load, derate current by 20%.

Characteristic	Symbol	HER 101G	HER 102G	HER 103G	HER 104G	HER 105G	HER 106G	HER 107G	HER 108G	Unit	
Peak Repetitive Reverse Voltage	V_{RRM}	50	100	200	300	400	600	800	1000	V	
Working Peak Reverse Voltage	V_{RWM}										
DC Blocking Voltage	V_R										
RMS Reverse Voltage	$V_{R(RMS)}$	35	70	140	210	280	420	560	700	V	
Average Rectified Output Current (Note 1)	I_O	1.0								A	
Non-Repetitive Peak Forward Surge Current 8.3ms Single half sine-wave superimposed on rated load (JEDEC Method)	I_{FSM}	30								A	
Forward Voltage @ $I_F = 1.0A$	V_{FM}	1.0			1.3		1.7			V	
Peak Reverse Current @ $T_A = 25^\circ\text{C}$ At Rated DC Blocking Voltage @ $T_A = 100^\circ\text{C}$	I_{RM}	5.0				100					μA
Reverse Recovery Time (Note 2)	t_{rr}	50				75					nS
Typical Junction Capacitance (Note 3)	C_j	20				15					pF
Operating Temperature Range	T_j	-65 to +150								$^\circ\text{C}$	
Storage Temperature Range	T_{STG}	-65 to +150								$^\circ\text{C}$	

Note: 1. Leads maintained at ambient temperature at a distance of 9.5mm from the case
 2. Measured with $I_F = 0.5A$, $I_R = 1.0A$, $IRR = 0.25A$. See figure 5.
 3. Measured at 1.0 MHz and applied reverse voltage of 4.0V D.C.

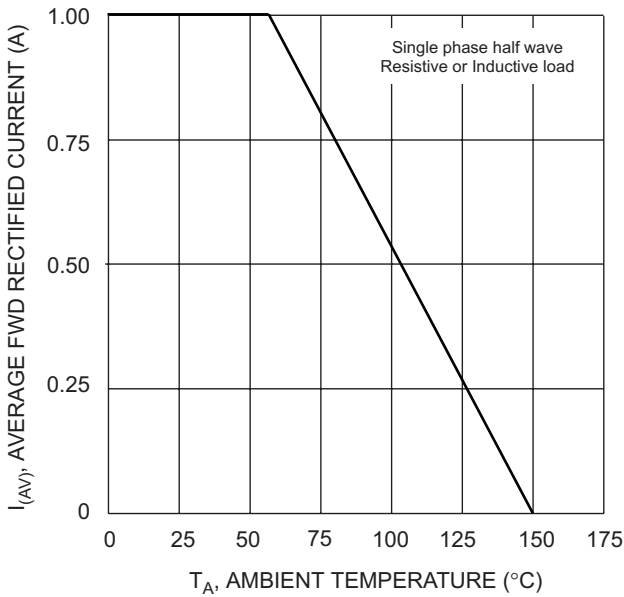

Fig. 1 Forward Current Derating Curve

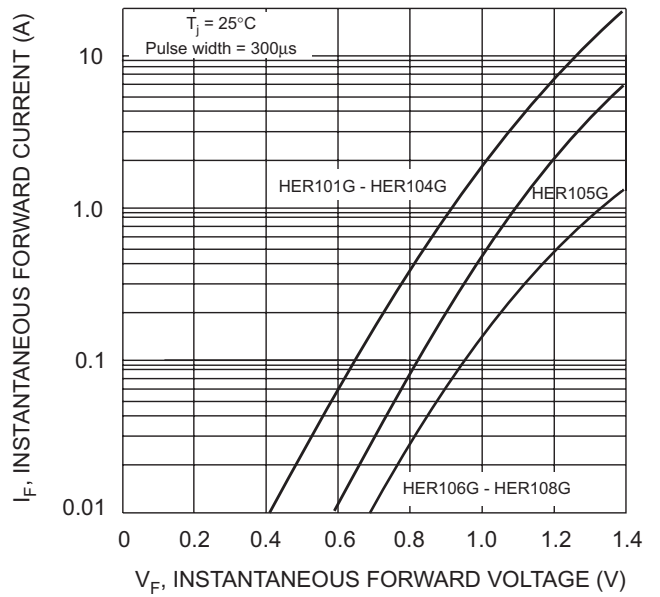

Fig. 2 Typical Forward Characteristics

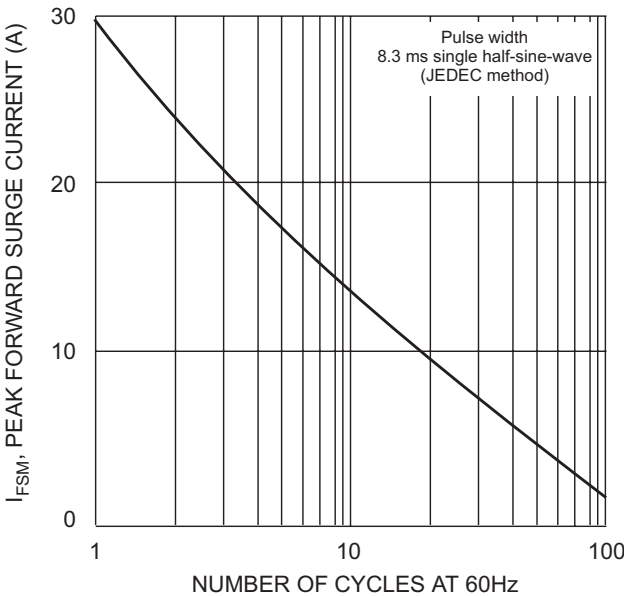

Fig. 3 Peak Forward Surge Current

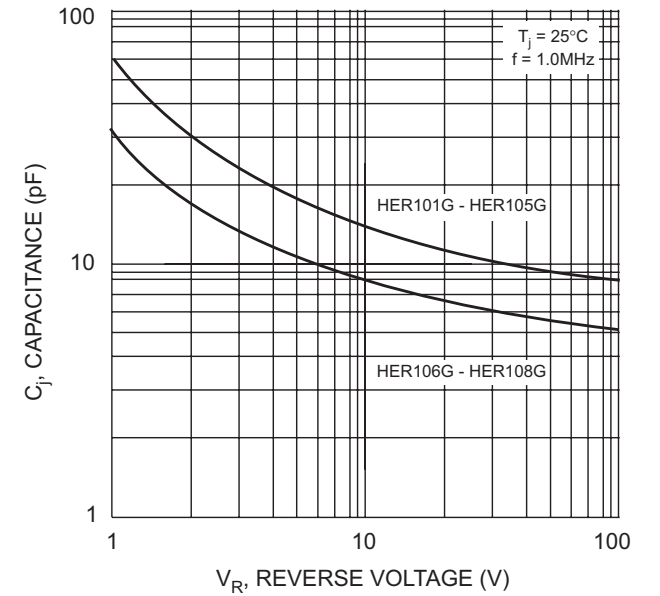
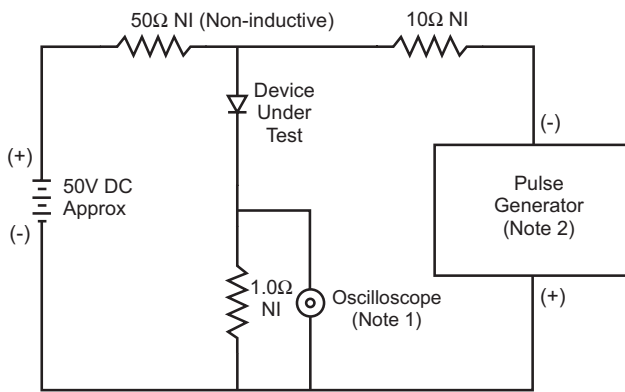
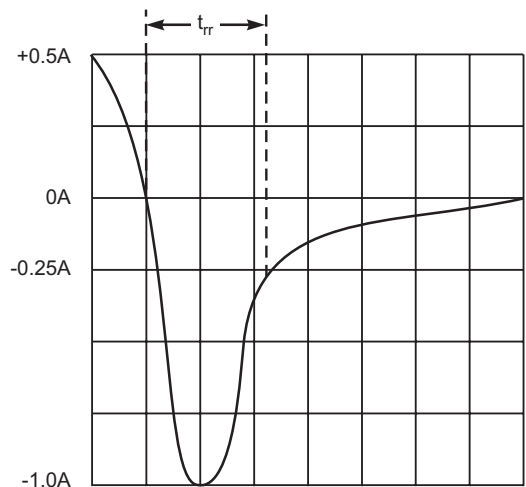

Fig. 4 Typical Junction Capacitance



- Notes:
1. Rise Time = 7.0ns max. Input Impedance = 1.0MΩ, 22pF.
 2. Rise Time = 10ns max. Input Impedance = 50Ω.



Set time base for 5/10ns/cm

Fig. 5 Reverse Recovery Time Characteristic and Test Circuit

MARKING INFORMATION

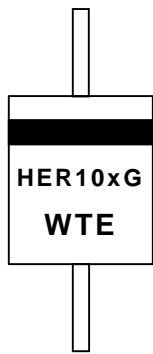

Cathode = Polarity Band
 HER10xG = Device Number
 x = 1, 2, 3, 4, 5, 6, 7 or 8
 WTE = Manufacturer's Logo

TAPING SPECIFICATIONS

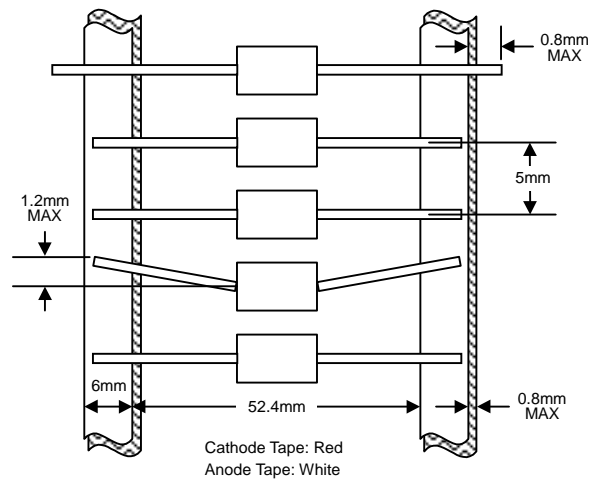

PACKAGING INFORMATION

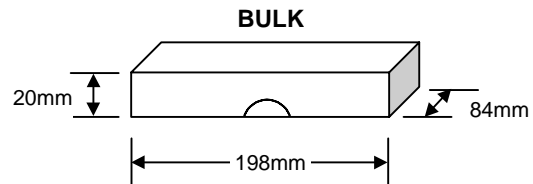
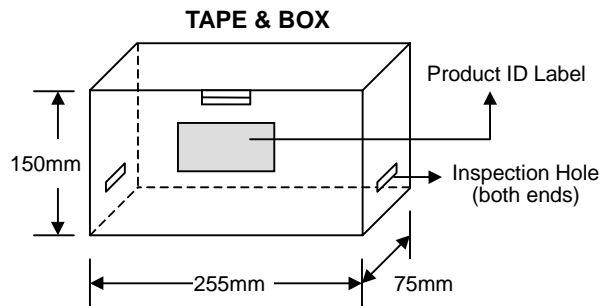

Packaging	Reel Diameter / Box Size (mm)	Quantity (PCS)	Carton Size (mm)	Quantity (PCS)	Approx. Gross Weight (KG)
TAPE & REEL	330	5,000	370 x 370 x 420	25,000	13.0
TAPE & BOX	255 x 75 x 150	5,000	400 x 273 x 415	50,000	21.0
BULK	198 x 84 x 20	1,000	459 x 214 x 256	50,000	19.5

Note: 1. Paper reel, white or gray color. Core material: plastic or metal.
 2. Components are packed in accordance with EIA standard RS-296-E.

ORDERING INFORMATION

Product No.	Package Type	Shipping Quantity
HER101G-T3	DO-41	5000/Tape & Reel
HER101G-TB	DO-41	5000/Tape & Box
HER101G	DO-41	1000 Units/Box
HER102G-T3	DO-41	5000/Tape & Reel
HER102G-TB	DO-41	5000/Tape & Box
HER102G	DO-41	1000 Units/Box
HER103G-T3	DO-41	5000/Tape & Reel
HER103G-TB	DO-41	5000/Tape & Box
HER103G	DO-41	1000 Units/Box
HER104G-T3	DO-41	5000/Tape & Reel
HER104G-TB	DO-41	5000/Tape & Box
HER104G	DO-41	1000 Units/Box
HER105G-T3	DO-41	5000/Tape & Reel
HER105G-TB	DO-41	5000/Tape & Box
HER105G	DO-41	1000 Units/Box
HER106G-T3	DO-41	5000/Tape & Reel
HER106G-TB	DO-41	5000/Tape & Box
HER106G	DO-41	1000 Units/Box
HER107G-T3	DO-41	5000/Tape & Reel
HER107G-TB	DO-41	5000/Tape & Box
HER107G	DO-41	1000 Units/Box
HER108G-T3	DO-41	5000/Tape & Reel
HER108G-TB	DO-41	5000/Tape & Box
HER108G	DO-41	1000 Units/Box

1. Products listed in **bold** are WTE **Preferred** devices.
2. Shipping quantity given is for minimum packing quantity only. For minimum order quantity, please consult the Sales Department.
3. **To order RoHS / Lead Free version (with Lead Free finish), add "-LF" suffix to part number above. For example, HER101G-TB-LF.**

Won-Top Electronics Co., Ltd (WTE) has checked all information carefully and believes it to be correct and accurate. However, WTE cannot assume any responsibility for inaccuracies. Furthermore, this information does not give the purchaser of semiconductor devices any license under patent rights to manufacturer. WTE reserves the right to change any or all information herein without further notice.

WARNING: DO NOT USE IN LIFE SUPPORT EQUIPMENT. WTE power semiconductor products are not authorized for use as critical components in life support devices or systems without the express written approval.

Won-Top Electronics Co., Ltd.

No. 44 Yu Kang North 3rd Road, Chine Chen Dist., Kaohsiung, Taiwan

Phone: 886-7-822-5408 or 886-7-822-5410

Fax: 886-7-822-5417

Email: sales@wontop.com

Internet: http://www.wontop.com

We power your everyday.