

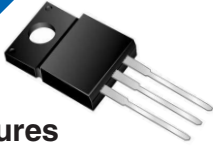

# MBRF1035CT thru MBRF1060CT

Crownpo Technology



## Dual Schottky Rectifiers

Reverse Voltage 35 to 60V  
Forward Current 10A

### Features

- Plastic package has Underwriters Laboratory Flammability Classification 94V-0
- Dual rectifier construction, positive center tap
- Metal silicon junction, majority carrier conduction
- Low power loss, high efficiency
- Guardring for overvoltage protection
- For use in low voltage, high frequency inverters, free wheeling, and polarity protection applications

### Mechanical Data

**Case:** JEDEC ITO-220AB molded plastic body

**Terminals:** Plated leads, solderable per MIL-STD-750, Method 2026

High temperature soldering guaranteed: 250°C/10 seconds, 0.25" (6.35mm) from case

**Polarity:** As marked

**Mounting Position:** Any

**Mounting Torque:** 10 in-lbs maximum

**Weight:** 0.08 oz., 2.24 g

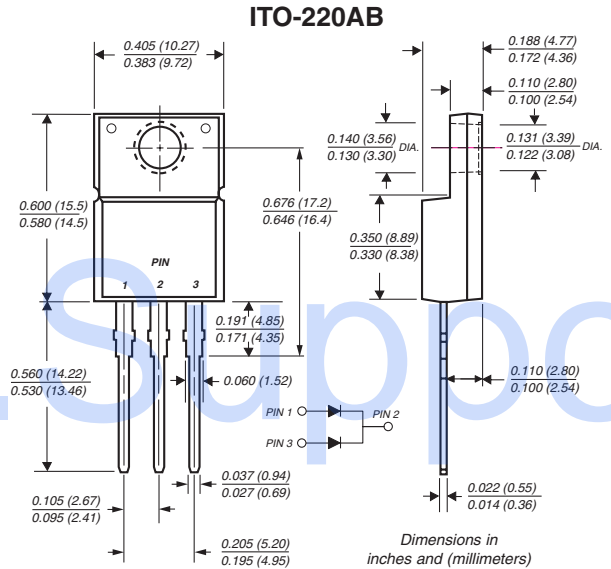

### Maximum Ratings and Thermal Characteristics (T<sub>c</sub> = 25°C unless otherwise noted)

Parameter	Symbol	MBRF 1035CT	MBRF 1040CT	MBRF 1045CT	MBRF 1050CT	MBRF 1060CT	Unit
Maximum repetitive peak reverse voltage	V <sub>RRM</sub>	35	40	45	50	60	V
Working peak reverse voltage	V <sub>RWM</sub>	35	40	45	50	60	V
Maximum DC blocking voltage	V <sub>DC</sub>	35	40	45	50	60	V
Maximum average forward rectified current <i>Total device</i> at T <sub>c</sub> = 105°C <i>Per leg</i>	I <sub>F(AV)</sub>	10 5					A
Peak forward surge current 8.3ms single half sine-wave superimposed on rated load (JEDEC Method) per leg	I <sub>FSM</sub>	150					A
Peak repetitive reverse current per leg at t <sub>p</sub> = 2μs, 1KHz	I <sub>RRM</sub>	1.0			0.5		A
Voltage rate of change (rated V <sub>R</sub> )	dv/dt	10,000					V/μs
Typical thermal resistance per leg	R <sub>θJC</sub>	5.0					°C/W
Operating junction and storage temperature range	T <sub>J</sub> , T <sub>STG</sub>	-65 to +150					°C
RMS Isolation voltage (MBRF type only) from terminals to heatsink with t = 1 second, RH ≤ 30%	V <sub>ISOL</sub>	4500 <sup>(1)</sup> 3500 <sup>(2)</sup> 1500 <sup>(3)</sup>					V

### Electrical Characteristics (T<sub>c</sub> = 25°C unless otherwise noted)

Maximum instantaneous forward voltage per leg <sup>(4)</sup> at I <sub>F</sub> = 5.0A, T <sub>C</sub> = 125°C at I <sub>F</sub> = 5.0A, T <sub>C</sub> = 25°C	V <sub>F</sub>	0.55		0.70		V
Maximum reverse current per leg at working peak reverse voltage <sup>(4)</sup> T <sub>J</sub> = 25°C T <sub>J</sub> = 100°C	I <sub>R</sub>	0.1 6.0				mA

- Notes:** (1) Clip mounting (on case), where lead does not overlap heatsink with 0.110" offset  
(2) Clip mounting (on case), where leads do overlap heatsink  
(3) Screw mounting with 4-40 screw, where washer diameter is ≤ 4.9 mm (0.19")  
(4) Pulse test: 300μs pulse width, 1% duty cycle



## Ratings and Characteristic Curves ( $T_A = 25^\circ\text{C}$ unless otherwise noted)

**Fig. 1 - Forward Current Derating Curve**

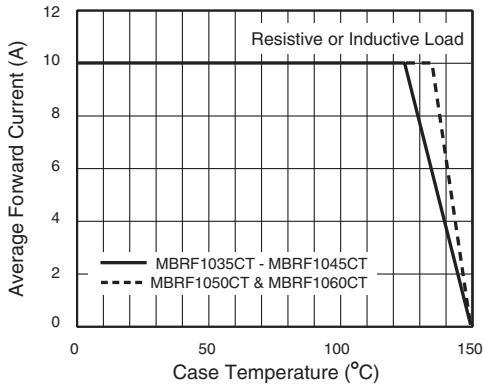

**Fig. 2 - Maximum Non-Repetitive Peak Forward Surge Current**

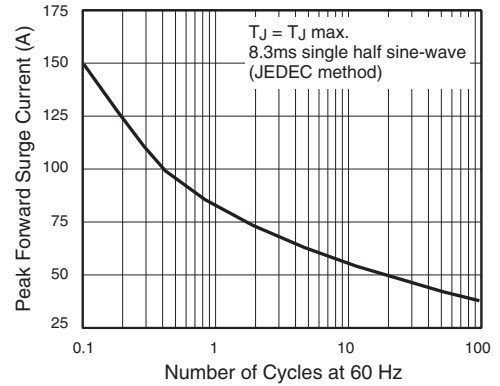

**Fig. 3 - Typical Instantaneous Forward Characteristics**

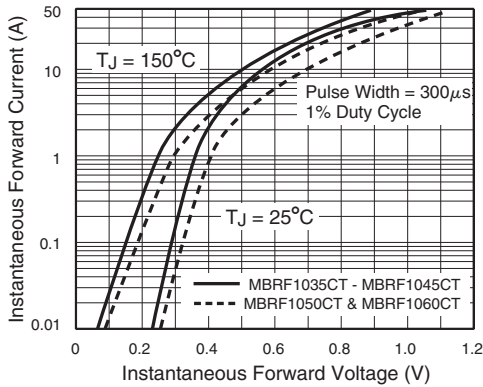

**Fig. 4 - Typical Reverse Characteristics**

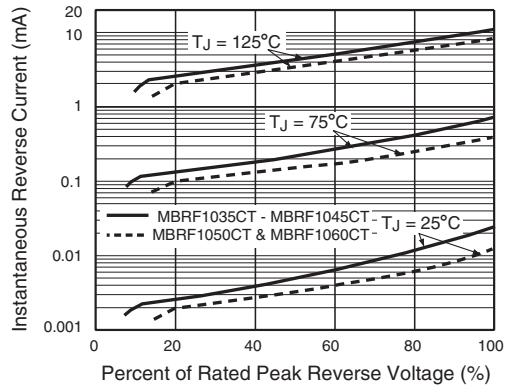

**Fig. 5 - Typical Junction Capacitance**

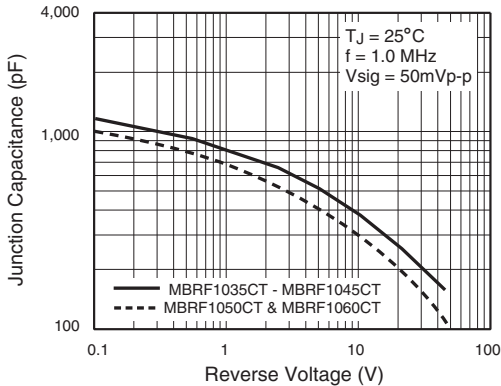

**Fig. 6 - Typical Transient Thermal Impedance**

