

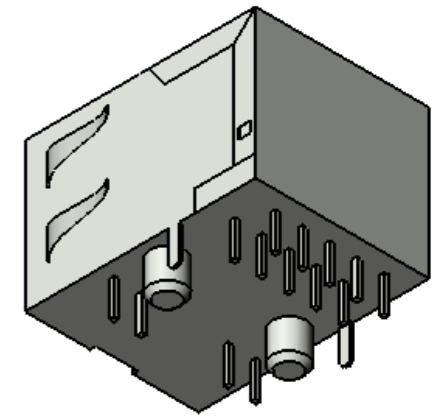

MC

**Recommended Hole Pattern  
View From Component Side**

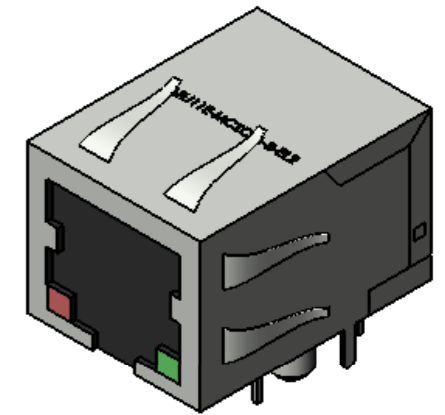
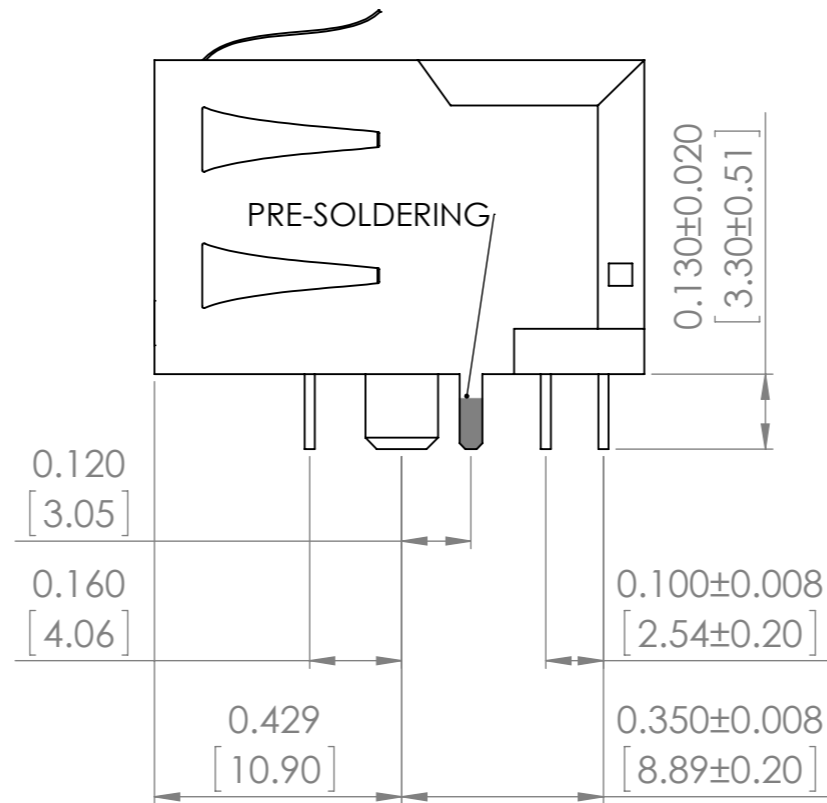
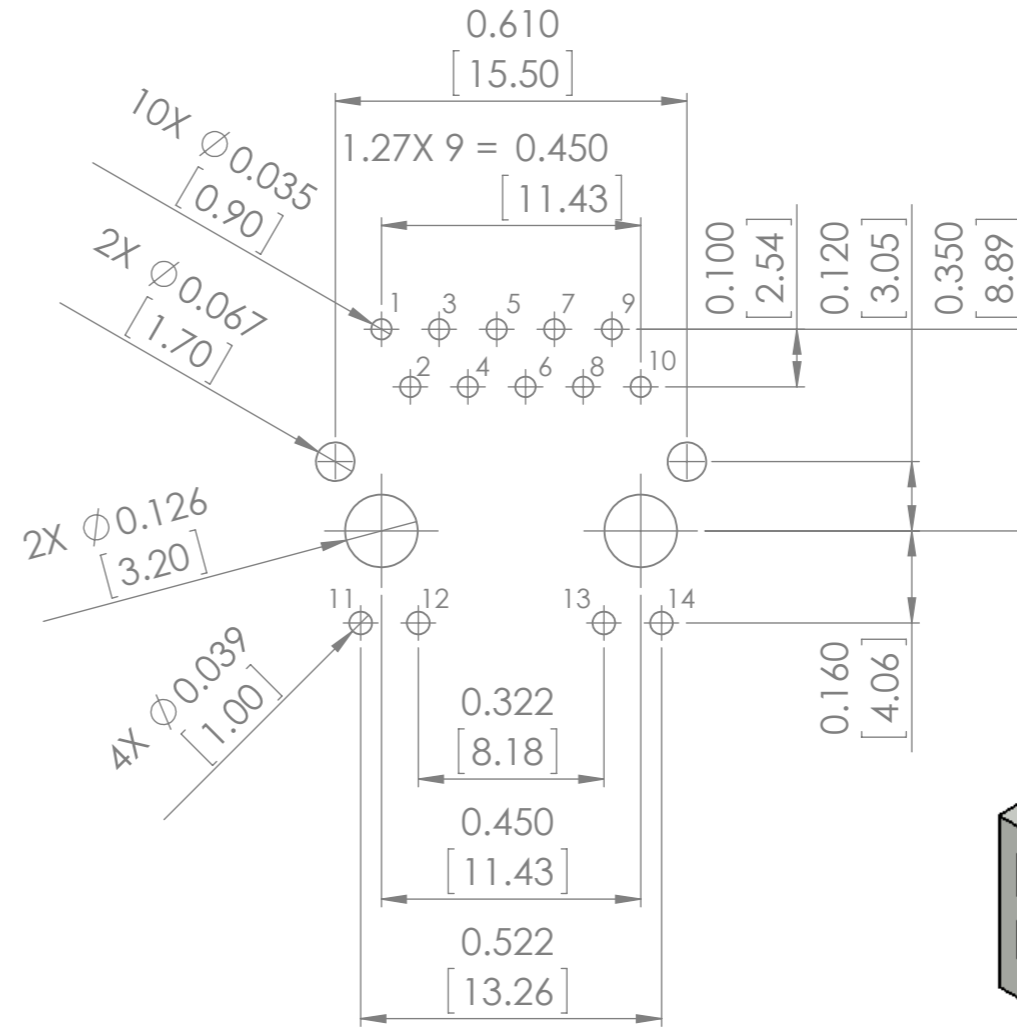
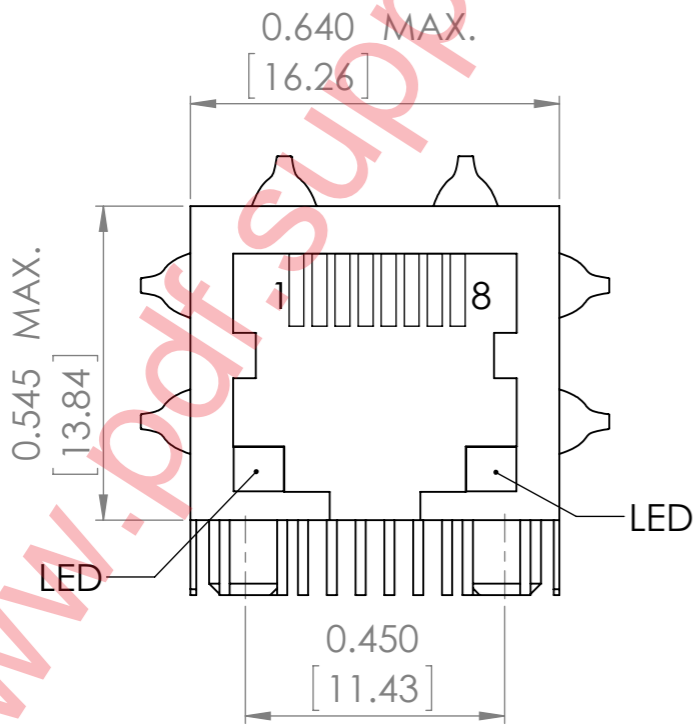
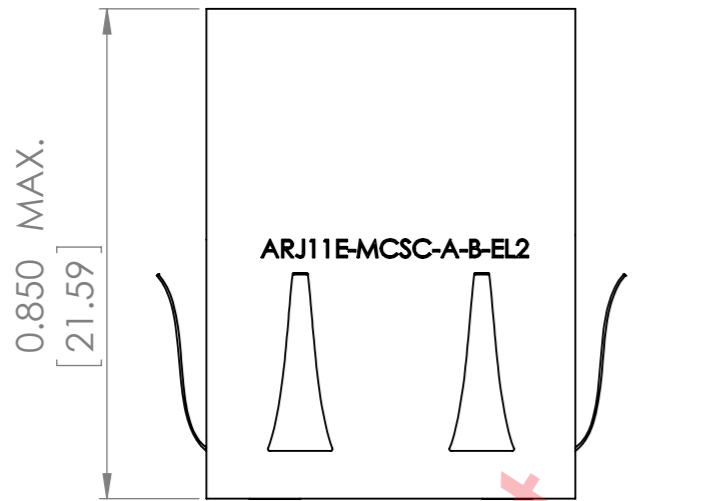

DO NOT SCALE DRAWING		REVISION	-
 <b>ABRACON</b> LLC <small>The Power of Linking Together</small>			
5101 Hidden Creek Lane, Spicewood Texas-78669			
TITLE:		RJ45	
DWG NO.		ARJ11E-MCSC-A-B-EL2	
SCALE: 3:1		A3	
		SHEET 1 OF 1	