

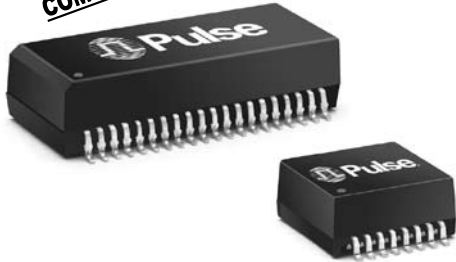



10/100BASE-TX TRANSFORMER MODULES

For Auto MDI/MDIX Applications



-  Symmetrical TX and RX channels for Auto MDI/MDIX capability
-  Approved for use with the Broadcom BCM5226 and Level One LXT9784
-  Meets IEEE 802.3 specification

Electrical Specifications @ 25°C — Operating Temperature 0°C to 70°C

RoHS-6 ² Compliant Part Number	RoHS-5 ² Compliant Part Number	Insertion Loss (MAX)	Return Loss (dB MIN)					Crosstalk (dB MIN)				Differential to Common Mode Rejection (dB MIN)		Hipot (Vrms MIN)
			0.1-100MHz	2-30MHz	40MHz	50MHz	60-80MHz	1kHz	30MHz	60MHz	100MHz	1-60MHz	60-200MHz	
H1140NL ^{3c}	H1140 ^{3c}	-1.0	-18	-14.4	-13.1	-12	-65	-50	-40	-35	-40	-35	1500	
H1141NL ^{3c}	—	-1.0	-18	-14.4	-13.1	-12	-65	-50	-40	-35	-40	-35	1500	
H1164NL ^{3d}	H1164 ^{3d}	-1.0	-18	-14.4	-13.1	-12	-55	-45	-40	-33	-37	-25	1500	
HX1234NL ^{1,3c}	HX1234 ^{1,3c}	-1.4	-18	-14.4	-13.1	-12	-55	-45	-40	-33	-37	-25	1500	
—	HX1240 ^{3c}	-1.0	-16.5	-16	-15.5	-12	-60	-43	-38	-33	-43	-27	1500	

1. Operating Temperature -40°C to +85°C
2. For Tape & Reel packaging, add a "T" suffix at the end of the part number when ordering, e.g. H1164T
3. MSL = Moisture Sensitivity Level a=1 b=2 c=3 d=4

Mechanicals

H1140, H1164, HX1234, HX1240

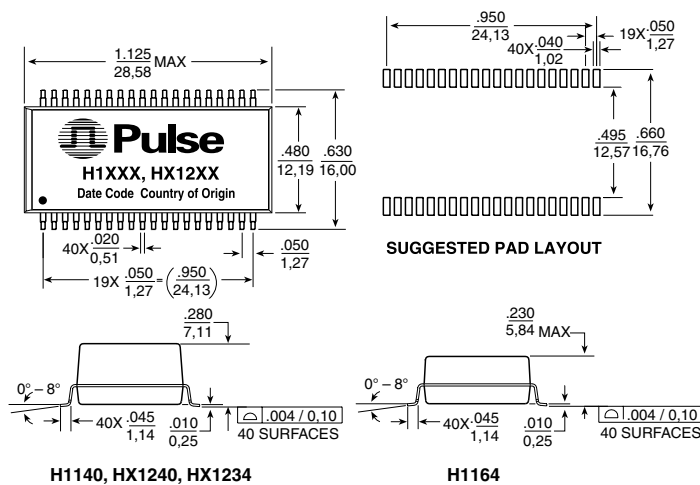

Weight 5.6 grams*
Tape & Reel 250/reel
Tube 15/tube

*H1164 = 4.4 grams

Dimensions: $\frac{\text{Inches}}{\text{mm}}$

Unless otherwise specified, all tolerances are $\pm \frac{.010}{0,25}$

H1141

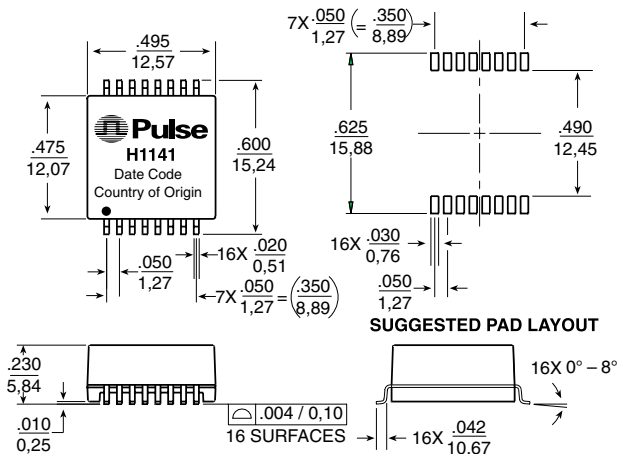

Weight 1 gram
Tape & Reel 350/reel
Tube 35/tube

10/100BASE-TX TRANSFORMER MODULES

For Auto MDI/MDIX Applications



Schematics

H1140, HX1240

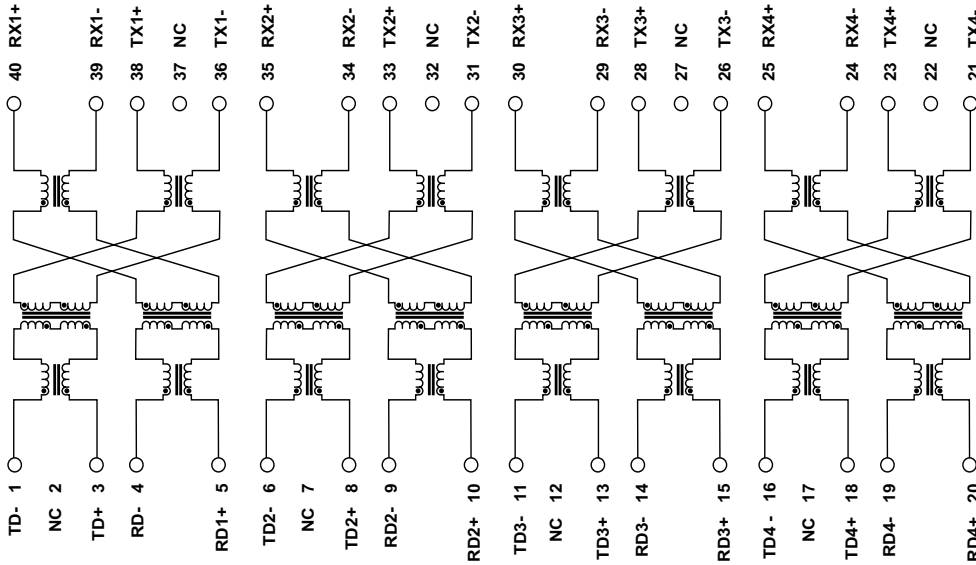

H1141

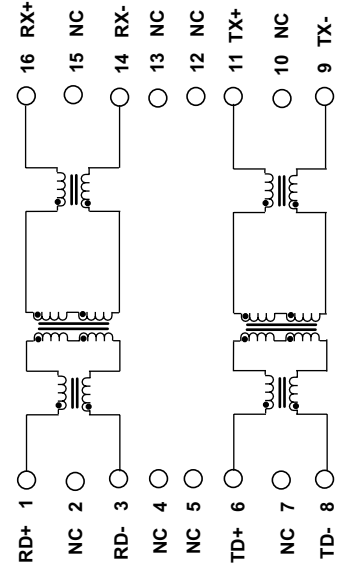

H1164, HX1234

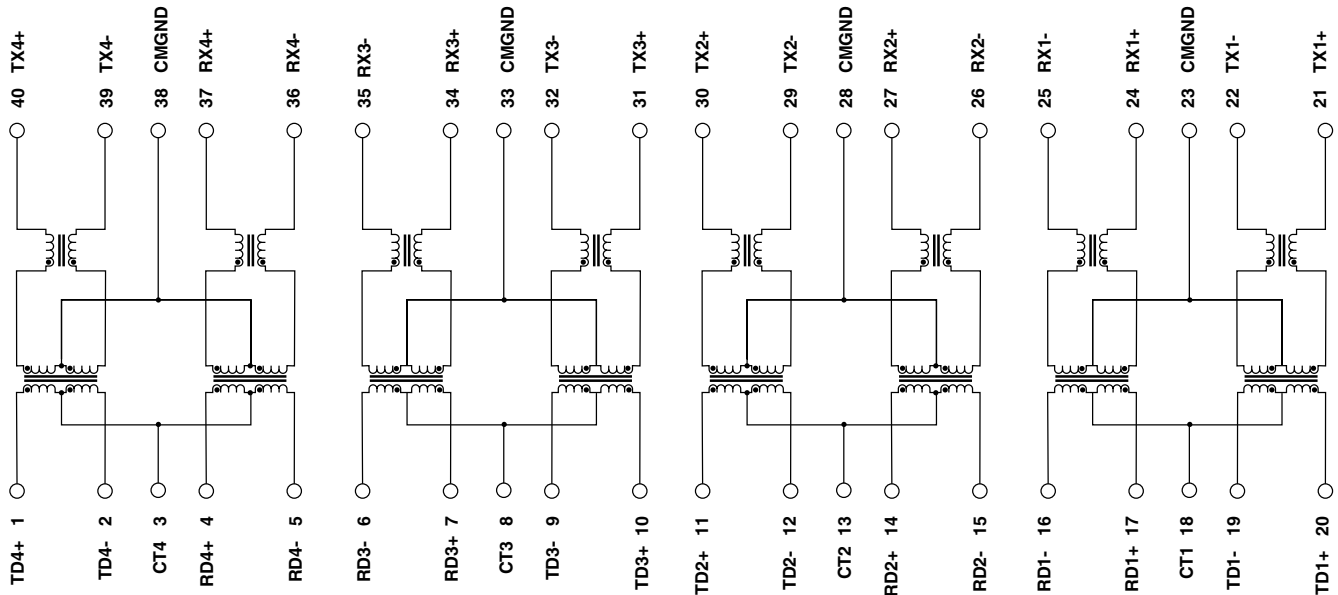

For More Information:

Pulse Worldwide Headquarters
12220 World Trade Dr.
San Diego, CA 92128
U.S.A.

Pulse Europe
Einsteinstrasse 1
D-71083 Herrenberg
Germany

Pulse China Headquarters
B402, Shenzhen Academy of
Aerospace Technology Bldg.
10th Kejinan Rd.
High-Tech Zone
Nanshan District
Shenzhen, PR China 518057

Pulse North China
Room 1503
XinYin Building
No. 888 YiShan Rd.
Shanghai 200233
China

Pulse South Asia
150 Kampong Ampat
#07-01/02
KA Centre
Singapore 368324

Pulse North Asia
No. 26, Kao Ching Rd.
Yang Mei Chen
Taoyuan Hsien
Taiwan
R. O. C.

www.pulseeng.com

Tel: 858 674 8100
Fax: 858 674 8262

Tel: 49 7032 7806 0
Fax: 49 7032 7806 135

TEL: 86 755 33966678
FAX: 86 755 33966700

Tel: 86 21 54643211/2
Fax: 86 21 54643210

Tel: 65 6287 8998
Fax: 65 6280 0080

Tel: 886 3 4643715
Fax: 886 3 4641911

Performance warranty of products offered on this data sheet is limited to the parameters specified. Data is subject to change without notice. Other brand and product names mentioned herein may be trademarks or registered trademarks of their respective owners.

© Copyright, 2008. Pulse Engineering, Inc. All rights reserved.