

# High Speed IGBT

**IXSH/IXST 30N60B**  
**IXSH/IXST 30N60C**

Short Circuit SOA Capability

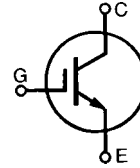

$V_{CES}$	$I_{CES}$	$t_{fi}$
600 V	2.0 V	140 ns
600 V	2.5 V	70 ns

Symbol	Test Conditions	Maximum Ratings	
$V_{CES}$	$T_J = 25^\circ\text{C}$ to $150^\circ\text{C}$	600	V
$V_{CGR}$	$T_J = 25^\circ\text{C}$ to $150^\circ\text{C}$ ; $R_{GE} = 1\text{ M}\Omega$	600	V
$V_{GES}$	Continuous	$\pm 20$	V
$V_{GEM}$	Transient	$\pm 30$	V
$I_{C25}$	$T_C = 25^\circ\text{C}$	55	A
$I_{C90}$	$T_C = 90^\circ\text{C}$	30	A
$I_{CM}$	$T_C = 25^\circ\text{C}$ , 1 ms	110	A
<b>SSOA (RBSOA)</b>	$V_{GE} = 15\text{ V}$ , $T_J = 125^\circ\text{C}$ , $R_G = 2.7\ \Omega$ Clamped inductive load, $V_{CC} = 0.8 V_{CES}$	$I_{CM} = 60$ @ $0.8 V_{CES}$	A
<b><math>t_{SC}</math> (SCSOA)</b>	$V_{GE} = 15\text{ V}$ , $V_{CE} = 360\text{ V}$ , $T_J = 125^\circ\text{C}$ $R_G = 33\ \Omega$ , non repetitive	10	$\mu\text{s}$
$P_c$	$T_C = 25^\circ\text{C}$	200	W
$T_J$		-55 ... +150	$^\circ\text{C}$
$T_{JM}$		150	$^\circ\text{C}$
$T_{stg}$		-55 ... +150	$^\circ\text{C}$
$M_d$	Mounting torque (TO-247)	1.13/10 Nm/lb.in.	
<b>Weight</b>	TO-247	6	g
	TO-268	4	g
Maximum lead temperature for soldering 1.6 mm (0.062 in.) from case for 10 s		300	$^\circ\text{C}$

TO-247 AD (IXSH)

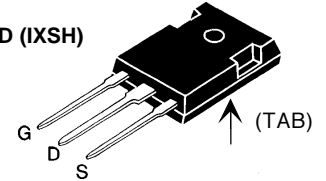

TO-268 (D3) (IXST)

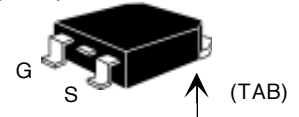

G = Gate  
S = Source

TAB = Drain

## Features

- International standard packages
- Short Circuit SOA capability
- High frequency IGBT
- New generation HDMOS™ process

## Applications

- AC motor speed control
- DC servo and robot drives
- DC choppers
- Uninterruptible power supplies (UPS)
- Switch-mode and resonant-mode power supplies

## Advantages

- Easy to mount with 1 screw (isolated mounting screw hole)
- Surface mountable, high power case style
- Reduce assembly time and cost
- High power density

Symbol	Test Conditions	Characteristic Values ( $T_J = 25^\circ\text{C}$ , unless otherwise specified)		
		min.	typ.	max.
$BV_{CES}$	$I_C = 250\ \mu\text{A}$ , $V_{GE} = 0\text{ V}$	600		V
$V_{GE(th)}$	$I_C = 2.5\text{ mA}$ , $V_{CE} = V_{GE}$	4		V
$I_{CES}$	$V_{CE} = 0.8 V_{CES}$ $V_{GE} = 0\text{ V}$	$T_J = 25^\circ\text{C}$		100 $\mu\text{A}$
		$T_J = 125^\circ\text{C}$		1 mA
$I_{GES}$	$V_{CE} = 0\text{ V}$ , $V_{GE} = \pm 20\text{ V}$			$\pm 100\text{ nA}$
$V_{CE(sat)}$	$V_{GE} = 15\text{ V}$ ; $I_C = I_{C90}$	30N60B		2.0 V
		30N60C		2.5 V

Symbol	Test Conditions	Characteristic Values ( $T_J = 25^\circ\text{C}$ , unless otherwise specified)			
		min.	typ.	max.	
$g_{fs}$	$I_C = I_{C90}$ ; $V_{CE} = 10\text{ V}$ , Pulse test, $t \leq 300\ \mu\text{s}$ , duty cycle $\leq 2\%$	10		S	
$C_{ies}$			3100	pF	
$C_{oes}$	$V_{CE} = 25\text{ V}$ , $V_{GE} = 0\text{ V}$ , $f = 1\text{ MHz}$		240	pF	
$C_{res}$			30	pF	
$Q_g$			100	nC	
$Q_{ge}$	$I_C = I_{C90}$ , $V_{GE} = 15\text{ V}$ , $V_{CE} = 0.5 V_{CES}$		30	nC	
$Q_{gc}$			38	nC	
$t_{d(on)}$			30	ns	
$t_{ri}$	<b>Inductive load, <math>T_J = 25^\circ\text{C}</math></b>		30	ns	
$t_{d(off)}$	$I_C = I_{C90}$ , $V_{GE} = 15\text{ V}$ $V_{CE} = 0.8 V_{CES}$ , $R_G = 4.7\ \Omega$	30N60B	150	270	ns
$t_{fi}$	Note 1	30N60C	90	150	ns
		30N60B	140	270	ns
		30N60C	70	120	ns
$E_{off}$		30N60B	1.5	2.5	mJ
		30N60C	0.7	1.2	mJ
$t_{d(on)}$	<b>Inductive load, <math>T_J = 125^\circ\text{C}</math></b>		35	ns	
$t_{ri}$			35	ns	
$E_{on}$	$I_C = I_{C90}$ , $V_{GE} = 15\text{ V}$ $V_{CE} = 0.8 V_{CES}$ , $R_G = 4.7\ \Omega$		0.5	mJ	
$t_{d(off)}$	Note 1	30N60B	270	ns	
		30N60C	150	ns	
$t_{fi}$		30N60B	250	ns	
		30N60C	140	ns	
$E_{off}$		30N60B	2.5	mJ	
		30N60C	1.2	mJ	
$R_{thJC}$				0.62	K/W
$R_{thCK}$	(TO-247)		0.25	K/W	

Notes: 1. Switching times may increase for  $V_{CE}$  (Clamp)  $> 0.8 V_{CES}$ , higher  $T_J$  or increased  $R_G$ .

### Min Recommended Footprint

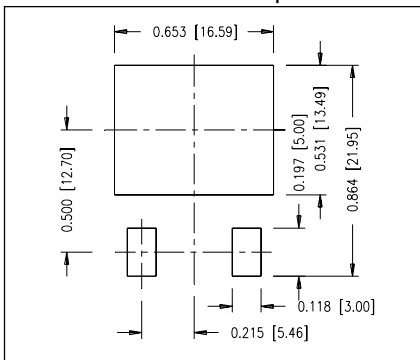

### TO-247 AD Outline

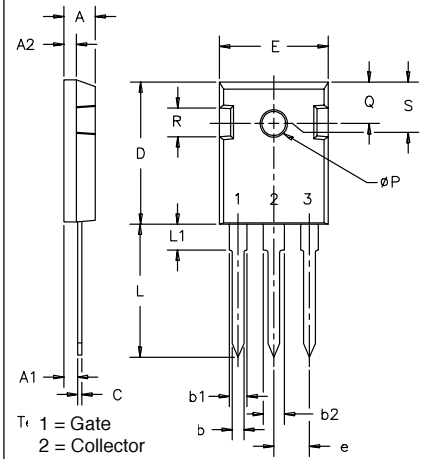

SYM	INCHES		MILLIMETERS	
	MIN	MAX	MIN	MAX
A	.185	.209	4.7	5.3
A1	.087	.102	2.2	2.54
A2	.059	.098	2.2	2.6
b	.040	.055	1.0	1.4
b1	.065	.084	1.65	2.13
b2	.113	.123	2.87	3.12
C	.016	.031	.4	.8
D	.819	.845	20.80	21.46
E	.610	.640	15.75	16.26
e	.215 BSC		5.45 BSC	
L	.780	.800	19.81	20.32
L1		.177		4.50
$\phi P$	.140	.144	3.55	3.65
Q	.212	.244	5.4	6.2
R	.170	.216	4.32	5.49
S	.242 BSC		6.15 BSC	

### TO-268 Outline

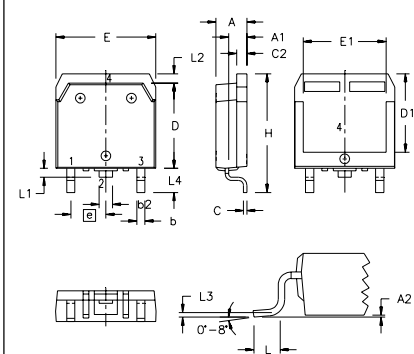

SYM	INCHES		MILLIMETERS	
	MIN	MAX	MIN	MAX
A	.193	.201	4.90	5.10
A1	.106	.114	2.70	2.90
A2	.001	.010	0.02	0.25
b	.045	.057	1.15	1.45
b2	.075	.083	1.90	2.10
C	.016	.026	0.40	0.65
C2	.057	.063	1.45	1.60
D	.543	.551	13.80	14.00
D1	.488	.500	12.40	12.70
E	.624	.632	15.85	16.05
E1	.524	.535	13.30	13.60
e	.215 BSC		5.45 BSC	
H	.736	.752	18.70	19.10
L	.094	.106	2.40	2.70
L1	.047	.055	1.20	1.40
L2	.039	.045	1.00	1.15
L3	.010 BSC		0.25 BSC	
L4	.150	.161	3.80	4.10

IXYS reserves the right to change limits, test conditions, and dimensions.

IXYS MOSFETS and IGBTs are covered by one or more of the following U.S. patents: 4,835,592 4,881,106 5,017,508 5,049,961 5,187,117 5,486,715  
4,850,072 4,931,844 5,034,796 5,063,307 5,237,481 5,381,025

Fig.1 Saturation Characteristics

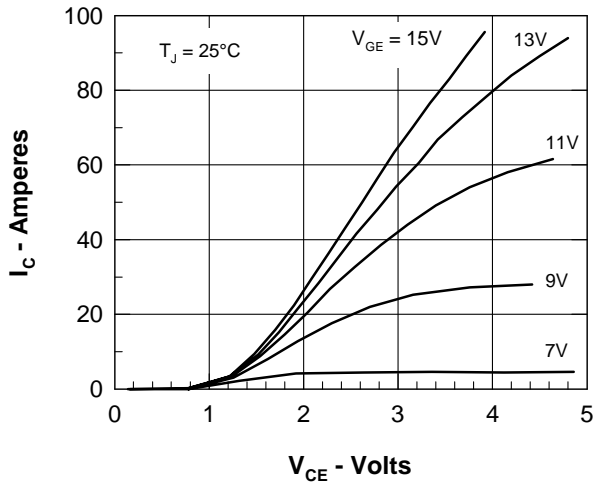

Fig.2 Output Characteristics

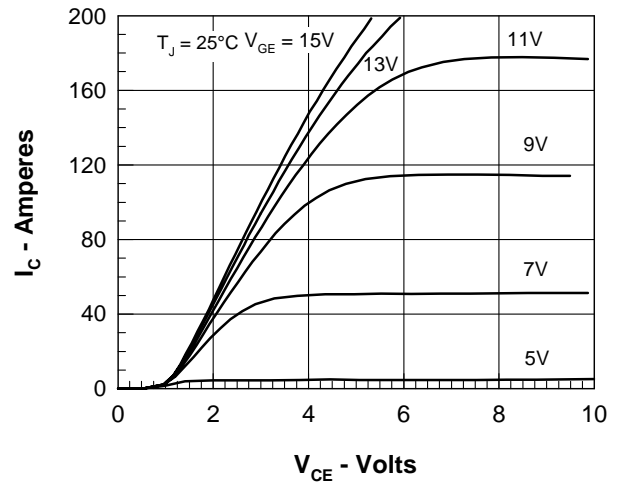

Fig.3 Collector-Emitter Voltage vs. Gate-Emitter Voltage

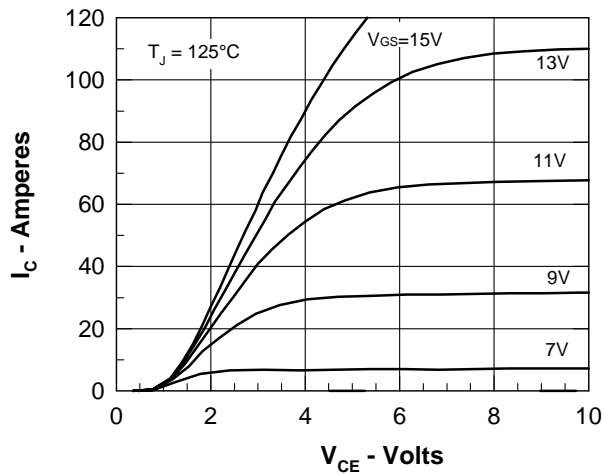

Fig.4 Temperature Dependence of Output Saturation Voltage

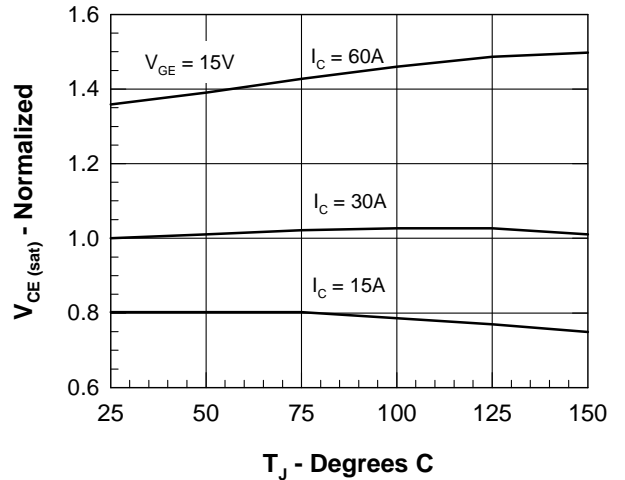

Fig.5 Input Admittance

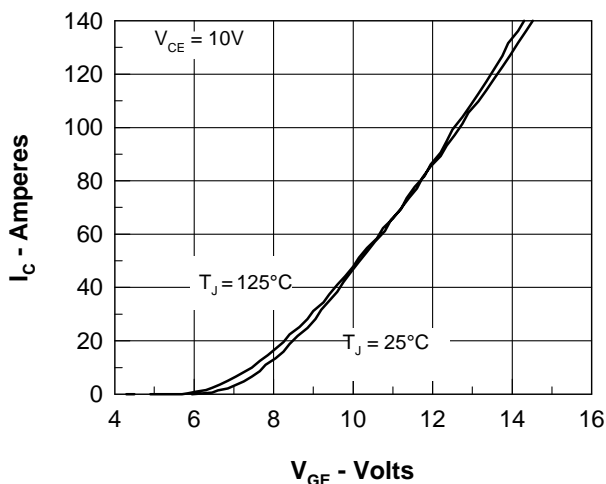
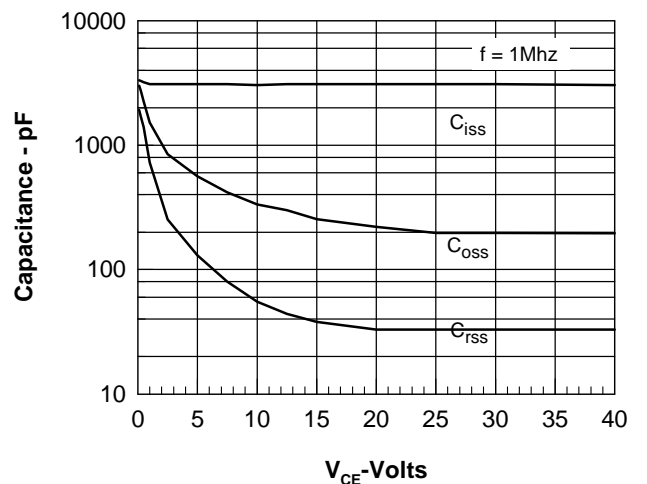
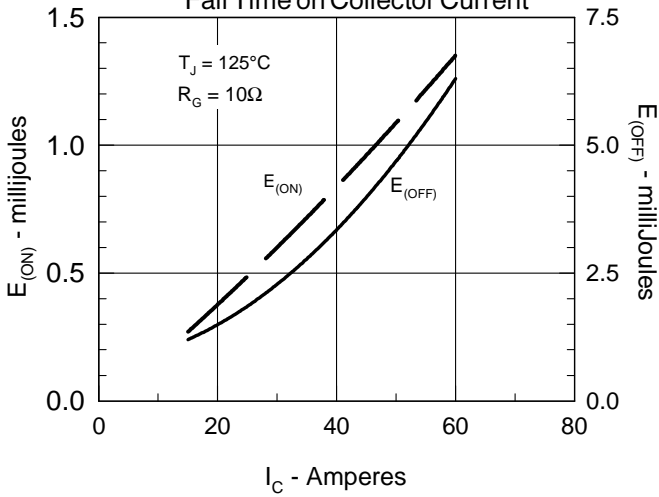

Fig.6 Temperature Dependence of Breakdown and Threshold Voltage



**Fig.7 Turn-Off Energy per Pulse and Fall Time on Collector Current**



**Fig.8 Dependence of Turn-Off Energy Per Pulse and Fall Time on R\_G**

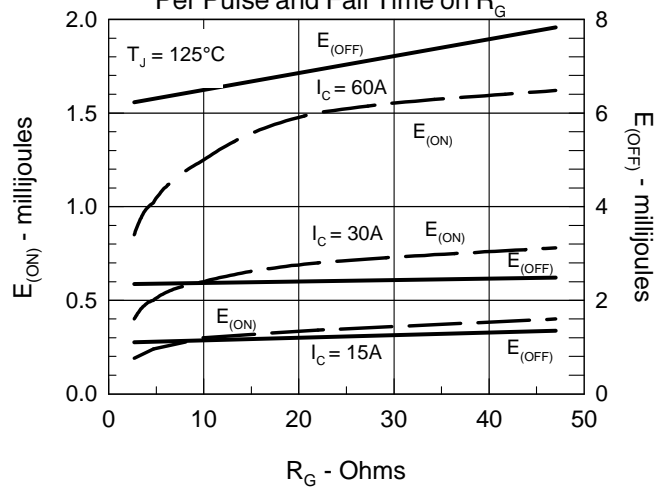

**Fig.9 Gate Charge Characteristic Curve**

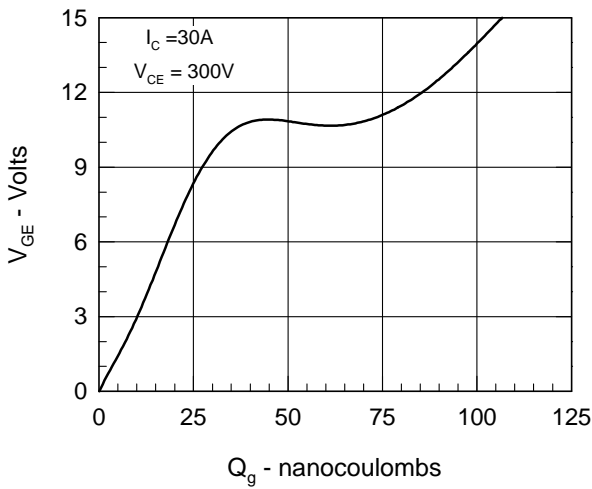

**Fig.10 Turn-Off Safe Operating Area**

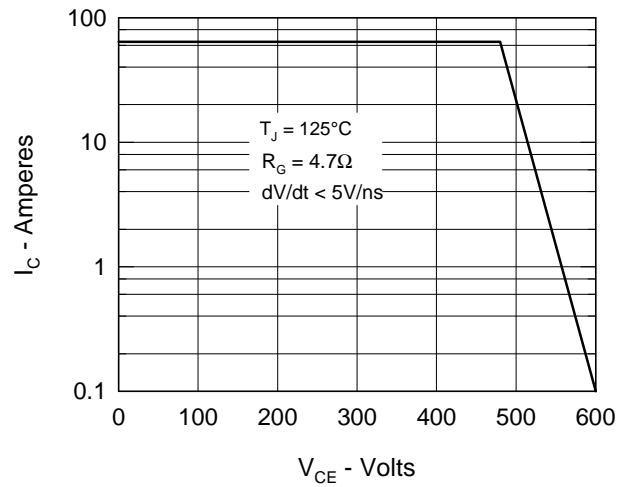

**Fig.11 Transient Thermal Impedance**

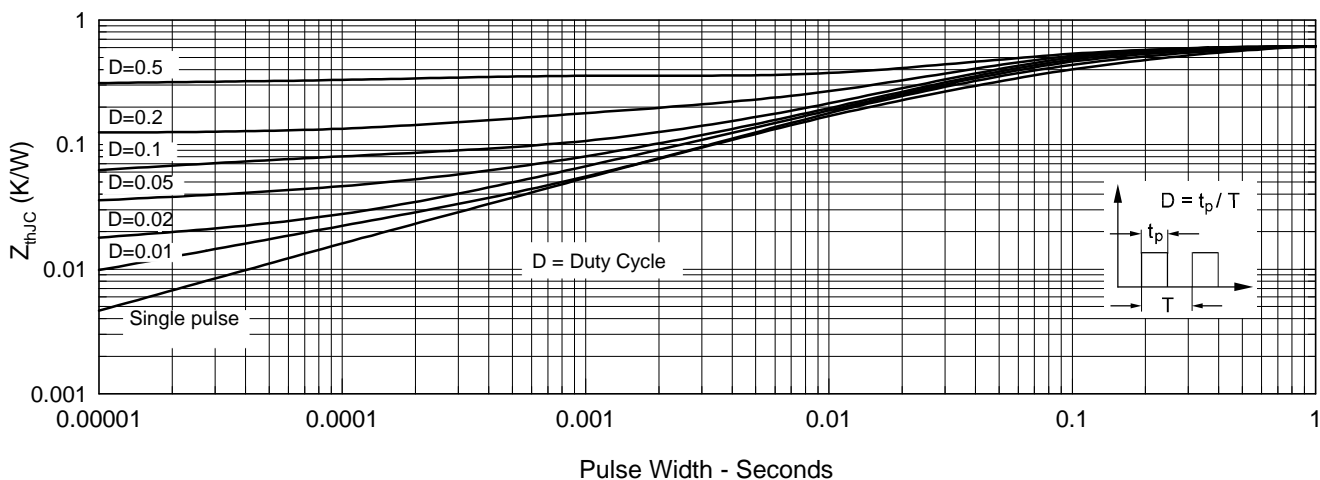

IXYS reserves the right to change limits, test conditions, and dimensions.

IXYS MOSFETS and IGBTs are covered by one or more of the following U.S. patents: 4,835,592 4,881,106 5,017,508 5,049,961 5,187,117 5,486,715  
4,850,072 4,931,844 5,034,796 5,063,307 5,237,481 5,381,025