

**NPN Silicon Darlington Transistors**

- For general AF applications
- High collector current
- High current gain
- Complementary types: BCV28, BCV48 (PNP)

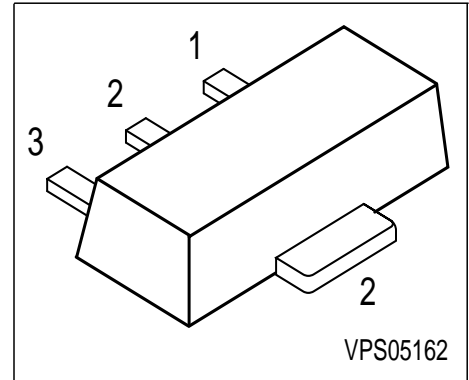

Type	Marking	Pin Configuration				Package
BCV29	EF	1 = B	2 = C	3 = E	4 = C	SOT89
BCV49	EG	1 = B	2 = C	3 = E	4 = C	SOT89

**Maximum Ratings**

Parameter	Symbol	BCV29	BCV49	Unit
Collector-emitter voltage	$V_{CEO}$	30	60	V
Collector-base voltage	$V_{CBO}$	40	80	
Emitter-base voltage	$V_{EBO}$	10	10	
DC collector current	$I_C$	500		mA
Peak collector current	$I_{CM}$	800		
Base current	$I_B$	100		
Peak base current	$I_{BM}$	200		
Total power dissipation, $T_S = 130\text{ °C}$	$P_{tot}$	1		W
Junction temperature	$T_j$	150		°C
Storage temperature	$T_{stg}$	-65 ... 150		

**Thermal Resistance**

Junction - soldering point <sup>1)</sup>	$R_{thJS}$	≤20	K/W
--	------------	-----	-----

<sup>1)</sup>For calculation of  $R_{thJA}$  please refer to Application Note Thermal Resistance

**Electrical Characteristics** at  $T_A = 25^\circ\text{C}$ , unless otherwise specified.

Parameter	Symbol	Values			Unit
		min.	typ.	max.	
<b>DC Characteristics</b>					
Collector-emitter breakdown voltage $I_C = 10\text{ mA}, I_B = 0$	$V_{(BR)CEO}$				V
BCV29		30	-	-	
BCV49		60	-	-	
Collector-base breakdown voltage $I_C = 100\ \mu\text{A}, I_B = 0$	$V_{(BR)CBO}$				
BCV29		40	-	-	
BCV49		80	-	-	
Emitter-base breakdown voltage $I_E = 10\ \mu\text{A}, I_C = 0$	$V_{(BR)EBO}$	10	-	-	
Collector cutoff current $V_{CB} = 30\text{ V}, I_E = 0$	$I_{CBO}$				nA
BCV29		-	-	100	
$V_{CB} = 60\text{ V}, I_E = 0$	BCV49			100	
Collector cutoff current $V_{CB} = 30\text{ V}, I_E = 0, T_A = 150^\circ\text{C}$	$I_{CBO}$				$\mu\text{A}$
BCV29		-	-	10	
$V_{CB} = 60\text{ V}, I_E = 0, T_A = 150^\circ\text{C}$	BCV49			10	
Emitter cutoff current $V_{EB} = 4\text{ V}, I_C = 0$	$I_{EBO}$	-	-	100	nA
DC current gain 1) $I_C = 100\ \mu\text{A}, V_{CE} = 1\text{ V}$	$h_{FE}$				-
BCV29		4000	-	-	
BCV49		2000	-	-	
DC current gain 1) $I_C = 10\text{ mA}, V_{CE} = 5\text{ V}$	$h_{FE}$				
BCV29		10000	-	-	
BCV49		4000	-	-	
DC current gain 1) $I_C = 100\text{ mA}, V_{CE} = 5\text{ V}$	$h_{FE}$				
BCV29		20000	-	-	
BCV49		10000	-	-	
DC current gain 1) $I_C = 0.5\text{ A}, V_{CE} = 5\text{ V}$	$h_{FE}$				
BCV29		4000	-	-	
BCV49		2000	-	-	

 1) Pulse test:  $t \leq 300\ \mu\text{s}$ ,  $D = 2\%$

**Electrical Characteristics** at  $T_A = 25^\circ\text{C}$ , unless otherwise specified.

Parameter	Symbol	Values			Unit
		min.	typ.	max.	
<b>DC Characteristics</b>					
Collector-emitter saturation voltage <sup>1)</sup> $I_C = 100\text{ mA}, I_B = 0.1\text{ mA}$	$V_{CEsat}$	-	-	1	V
Base-emitter saturation voltage 1) $I_C = 100\text{ mA}, I_B = 0.1\text{ mA}$	$V_{BEsat}$	-	-	1.5	
<b>AC Characteristics</b>					
Transition frequency $I_C = 50\text{ mA}, V_{CE} = 5\text{ V}, f = 100\text{ MHz}$	$f_T$	-	150	-	MHz
Collector-base capacitance $V_{CB} = 10\text{ V}, f = 1\text{ MHz}$	$C_{cb}$	-	3.5	-	pF

1) Pulse test:  $t \leq 300\mu\text{s}$ ,  $D = 2\%$

**Total power dissipation  $P_{tot} = f(T_S)$**

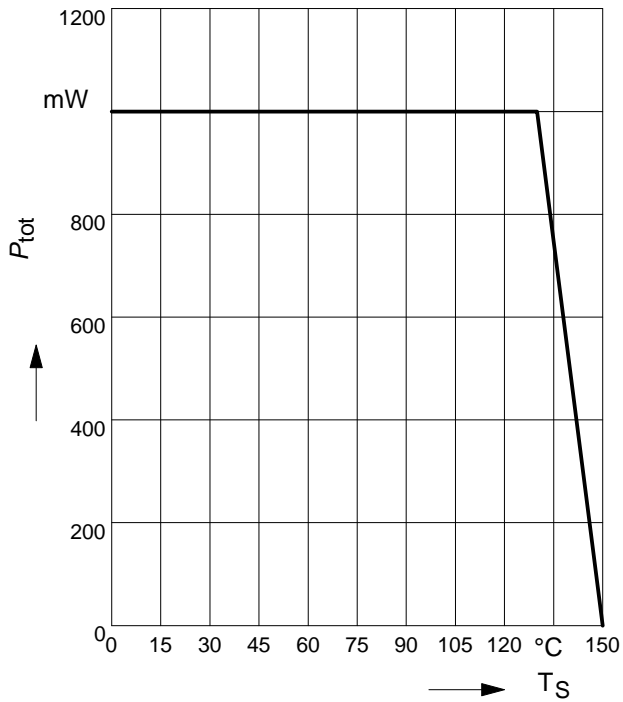

**Collector cutoff current  $I_{CBO} = f(T_A)$**

$V_{CB} = V_{CEmax}$

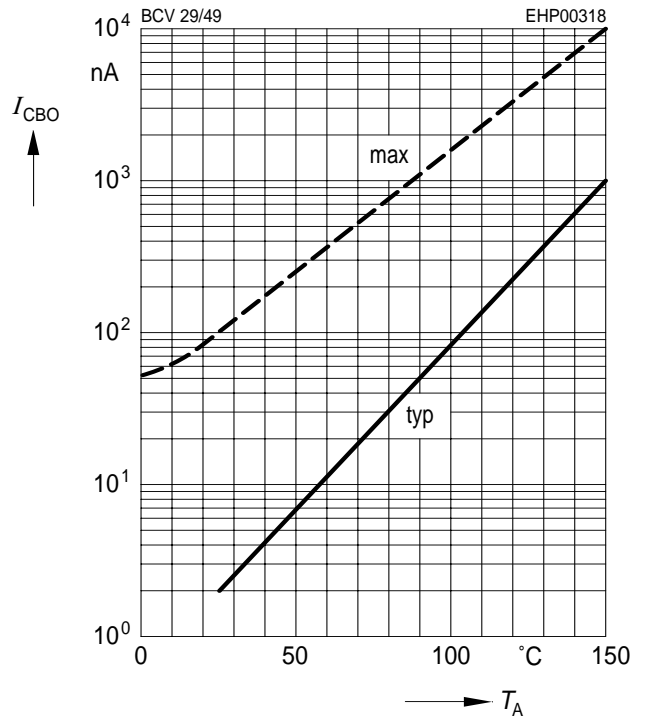

**Permissible pulse load**

$P_{totmax} / P_{totDC} = f(t_p)$

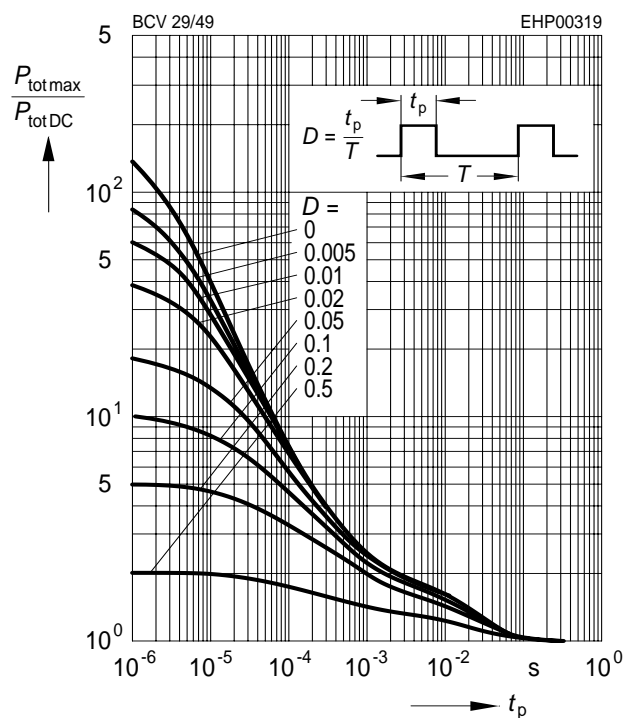

**Transition frequency  $f_T = f(I_C)$**

$V_{CE} = 5V$

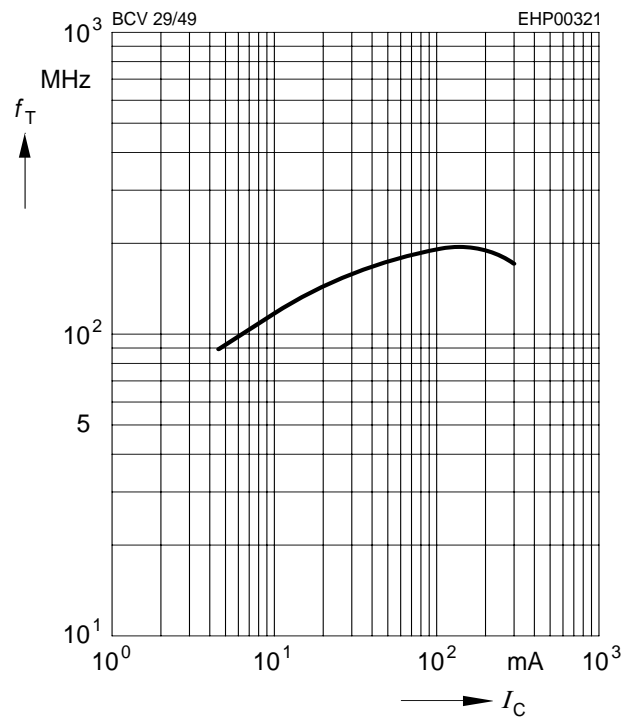

**Collector-emitter saturation voltage**

$I_C = f(V_{CEsat}), h_{FE} = 1000$

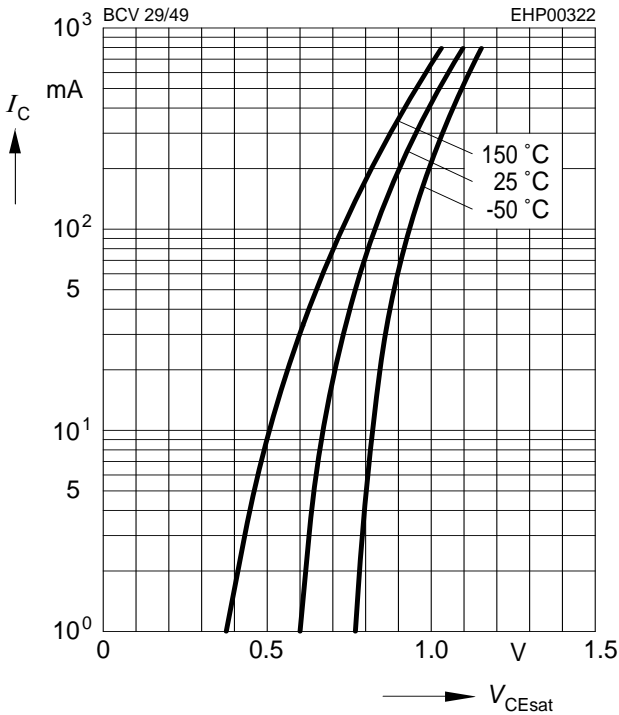

**Base-emitter saturation voltage**

$I_C = f(V_{BEsat}), h_{FE} = 1000$

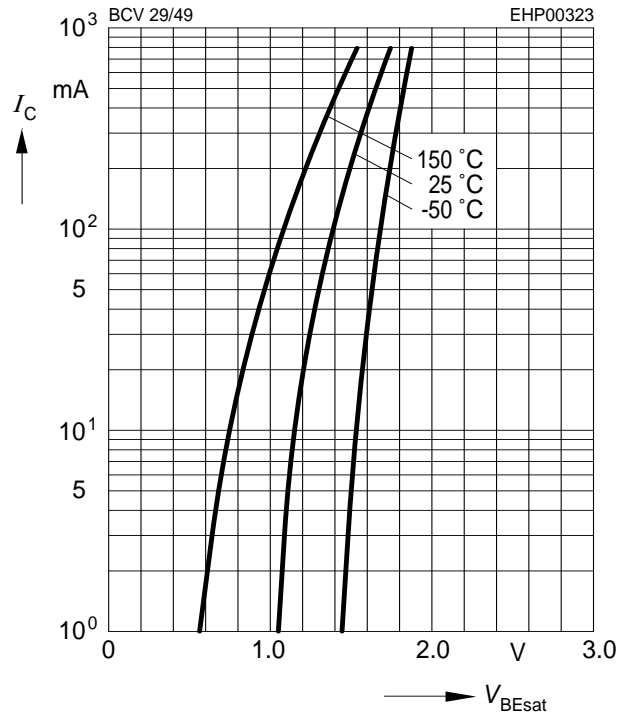

**Collector-base capacitance  $C_{CB} = f(V_{CB0})$   
Emitter-base capacitance  $C_{EB} = f(V_{EB0})$**

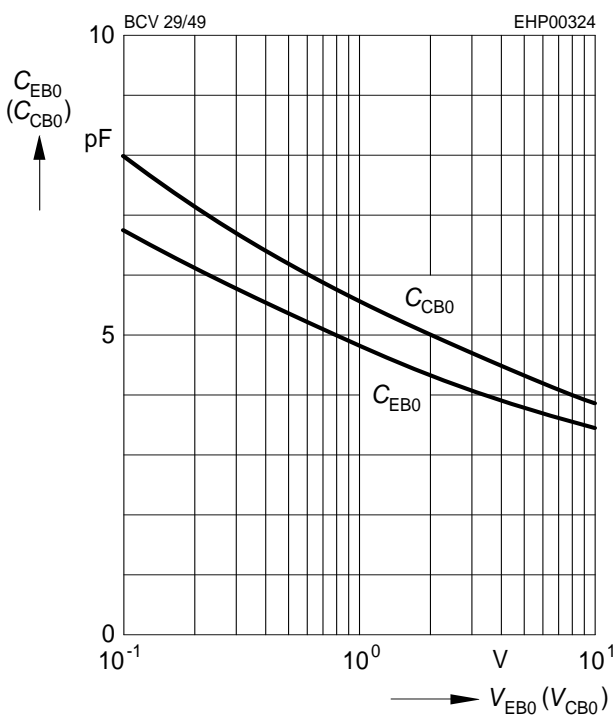

**DC current gain  $h_{FE} = f(I_C)$   
 $V_{CE} = 5V$**

