

LM306 DIFFERENTIAL COMPARATOR WITH STROBES

SLCS008A – OCTOBER 1979 – REVISED OCTOBER 1991

- Fast Response Times
- Improved Gain and Accuracy
- Fanout to 10 Series 54/74 TTL Loads
- Strobe Capability
- Short-Circuit and Surge Protection
- Designed to Be Interchangeable With National Semiconductor LM306

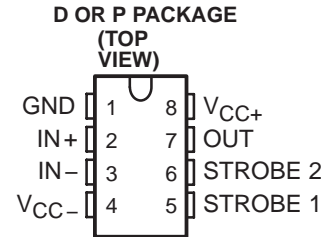

description

The LM306 is a high-speed voltage comparator with differential inputs, a low-impedance high-sink-current (100 mA) output, and two strobe inputs. This device detects low-level analog or digital signals and can drive digital logic or lamps and relays directly. Short-circuit protection and surge-current limiting is provided.

A low-level input at either strobe causes the output to remain high regardless of the differential input. When both strobe inputs are either open or at a high logic level, the output voltage is controlled by the differential input voltage. The circuit will operate with any negative supply voltage between -3 V and -12 V with little difference in performance.

The LM306 is characterized for operation from 0°C to 70°C .

functional block diagram

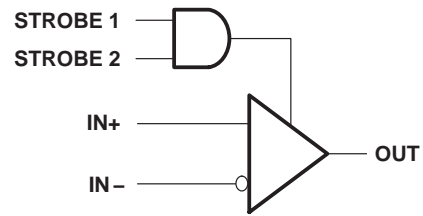

AVAILABLE OPTIONS

T_A	V_{IOmax} at 25°C	PACKAGE	
		SMALL OUTLINE (D)	PLASTIC DIP (P)
0°C to 70°C	5 mV	LM306D	LM306P

PRODUCTION DATA information is current as of publication date. Products conform to specifications per the terms of Texas Instruments standard warranty. Production processing does not necessarily include testing of all parameters.

**TEXAS
INSTRUMENTS**

POST OFFICE BOX 655303 • DALLAS, TEXAS 75265
POST OFFICE BOX 1443 • HOUSTON, TEXAS 77251-1443

Copyright © 1991, Texas Instruments Incorporated

LM306 DIFFERENTIAL COMPARATOR WITH STROBES

SLCS008A – OCTOBER 1979 – REVISED OCTOBER 1991

schematic

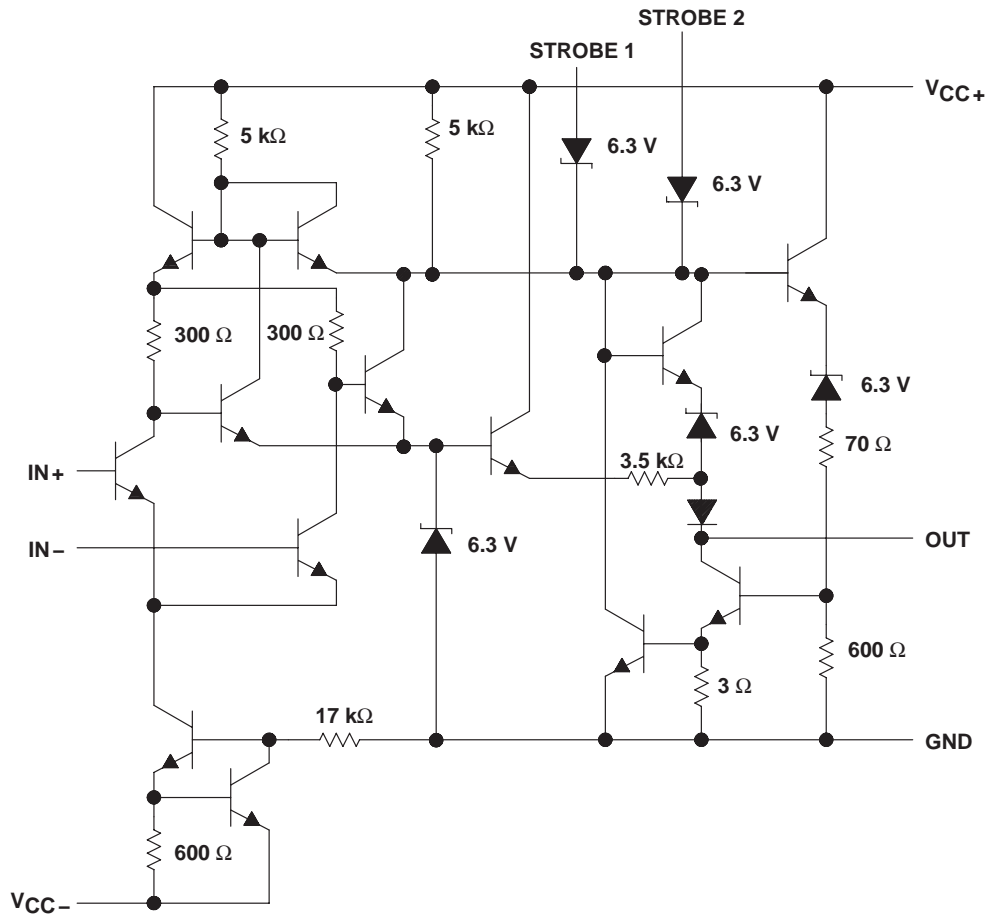

Resistor values are nominal.

LM306 DIFFERENTIAL COMPARATOR WITH STROBES

SLCS008A – OCTOBER 1979 – REVISED OCTOBER 1991

absolute maximum ratings over operating free-air temperature range (unless otherwise noted)†

Supply voltage, V_{CC+} (see Note 1)	15 V
Supply voltage, V_{CC-} (see Note 1)	-15 V
Differential input voltage, V_{ID} (see Note 2)	± 5 V
Input voltage, V_I (either input, see Notes 1 and 3)	± 7 V
Strobe voltage range (see Note 1)	0 V to V_{CC+}
Output voltage, V_O (see Note 1)	24 V
Voltage from output to V_{CC-}	30 V
Duration of output short circuit to ground (see Note 4)	10 s
Continuous total dissipation	See Dissipation Rating Table
Operating free-air temperature range, T_A	0°C to 70°C
Storage temperature range	-65°C to 150°C
Lead temperature 1,6 mm (1/16 inch) from case for 10 seconds	260°C

† Stresses beyond those listed under "absolute maximum ratings" may cause permanent damage to the device. These are stress ratings only, and functional operation of the device at these or any other conditions beyond those indicated under "recommended operating conditions" is not implied. Exposure to absolute-maximum-rated conditions for extended periods may affect device reliability.

- NOTES:
1. All voltage values, except differential voltages and the voltage from the output to V_{CC-} , are with respect to the network ground.
 2. Differential voltages are at $IN+$ with respect to $IN-$.
 3. The magnitude of the input voltage must never exceed the magnitude of the supply voltage or 7 V, whichever is less.
 4. The output may be shorted to ground or either power supply.

DISSIPATION RATING TABLE

PACKAGE	$T_A \leq 25^\circ\text{C}$ POWER RATING	DERATING FACTOR	DERATE ABOVE T_A	$T_A = 70^\circ\text{C}$ POWER RATING
D	600 mW	5.8 mW/ $^\circ\text{C}$	46°C	464 mW
P	600 mW	8.0 mW/ $^\circ\text{C}$	75°C	600 mW



LM306

DIFFERENTIAL COMPARATOR WITH STROBES

SLCS008A – OCTOBER 1979 – REVISED OCTOBER 1991

electrical characteristics at specified free-air temperature, $V_{CC+} = 12\text{ V}$, $V_{CC-} = -3\text{ V}$ to -12 V (unless otherwise noted)

PARAMETER		TEST CONDITIONS†	T_A ‡	MIN	TYP	MAX	UNIT	
V_{IO}	Input offset voltage	$R_S \leq 200\ \Omega$	25°C		1.6§	5	mV	
			Full range			6.5		
αV_{IO}	Average temperature coefficient of input offset voltage	$R_S = 50\ \Omega$, See Note 5	Full range		5	20	$\mu\text{V}/^\circ\text{C}$	
I_{IO}	Input offset current	See Note 5	25°C		1.8	5	μA	
			MIN		1	7.5		
			MAX		0.5	5		
αI_{IO}	Average temperature coefficient of input offset current	See Note 5	MIN to 25°C		24	100	$\text{nA}/^\circ\text{C}$	
			25°C to MAX		15	50		
I_{IB}	Input bias current	$V_O = 0.5\text{ V}$ to 5 V	MIN to 25°C			40	μA	
			25°C to MAX		16	25		
$I_{IL(S)}$	Low-level strobe current	$V(\text{strobe}) = 0.4\text{ V}$	Full range		-1.7	-3.2	mA	
$V_{IH(S)}$	High-level strobe voltage		Full range	2.2			V	
$V_{IL(S)}$	Low-level strobe voltage		Full range			0.9	V	
V_{ICR}	Common-mode input voltage range	$V_{CC-} = -7\text{ V}$ to -12 V	Full range	± 5			V	
V_{ID}	Differential input voltage range		Full range	± 5			V	
A_{VD}	Large-signal differential voltage amplification	$V_O = 0.5\text{ V}$ to 5 V , No load	25°C		40		V/mV	
V_{OH}	High-level output voltage	$I_{OH} = -400\ \mu\text{A}$ $V_{ID} = 8\text{ mV}$	Full range	2.5		5.5	V	
V_{OL}	Low-level output voltage	$I_{OL} = 100\text{ mA}$ $V_{ID} = -7\text{ mV}$	25°C		0.8	2	V	
		$I_{OL} = 50\text{ mA}$ $V_{ID} = -7\text{ mV}$	Full range			1		
		$I_{OL} = 16\text{ mA}$ $V_{ID} = -8\text{ mV}$	Full range			0.4		
I_{OH}	High-level output voltage	$V_{OH} = 8\text{ V}$ to 24 V	$V_{ID} = 7\text{ mV}$	MIN to 25°C		0.02	2	μA
			$V_{ID} = 8\text{ mV}$	25°C to MAX			100	
I_{CC+}	Supply current from V_{CC+}	$V_{ID} = -5\text{ mV}$, No load	Full range		6.6	10	mA	
I_{CC-}	Supply current from V_{CC-}	No load	Full range		-1.9	-3.6	mA	

† Unless otherwise noted, all characteristics are measured with both strobes open.

‡ Full range is 0°C to 70°C. MIN is 0°C. MAX is 70°C.

§ This typical value is at $V_{CC+} = 12\text{ V}$, $V_{CC-} = -6\text{ V}$.

NOTE 5: The offset voltages and offset currents given are the maximum values required to drive the output down to the low range (V_{OL}) or up to the high range (V_{OH}). These parameters actually define an error band and take into account the worst-case effects of voltage gain and input impedance.

switching characteristics, $V_{CC+} = 12\text{ V}$, $V_{CC-} = -6\text{ V}$, $T_A = 25^\circ\text{C}$

PARAMETER	TEST CONDITIONS†	MIN	TYP	MAX	UNIT
Response time, low-to-high-level output	$R_L = 390\ \Omega$ to 5 V , $C_L = 15\text{ pF}$, See Note 6		28	40	ns

† All characteristics are measured with both strobes open.

NOTE 6: The response time specified is for a 100-mV input step with 5-mV overdrive and is the interval between the input step function and the instant when the output crosses 1.4 V.



TYPICAL CHARACTERISTICS

Table of Graphs

			FIGURE
I_{IB}	Input bias current	vs Free-air temperature	1
I_{IO}	Input offset current	vs Free-air temperature	2
V_{OH}	High-level output voltage	vs Free-air temperature	3
V_{OL}	Low-level output voltage	vs Free-air temperature	4
V_O	Output voltage	vs Differential input voltage	5
I_O	Output current	vs Differential input voltage	6
A_{VD}	Large-signal differential voltage amplification	vs Free-air temperature	7
I_{OS}	Short-circuit output current	vs Free-air temperature	8
	Output response	vs Time	9, 10
I_{CC+}	Positive supply current	vs Positive supply voltage	11
I_{CC-}	Negative supply current	vs Negative supply voltage	12
P_D	Total power dissipation	vs Free-air temperature	13

**INPUT OFFSET CURRENT
vs
FREE-AIR TEMPERATURE**

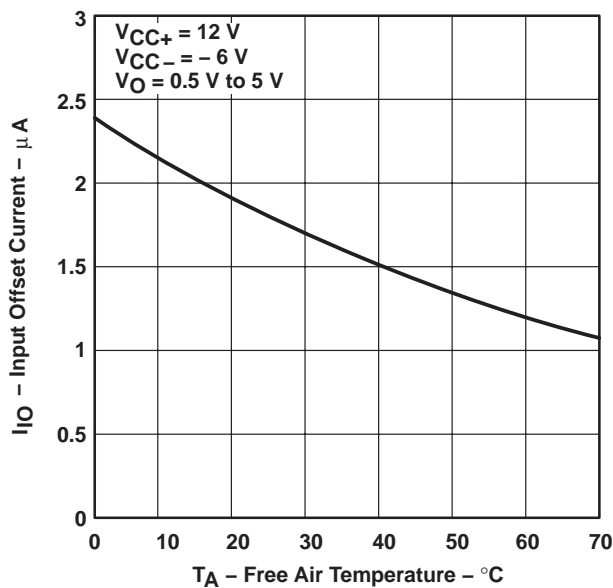

Figure 1

**INPUT BIAS CURRENT
vs
FREE-AIR TEMPERATURE**

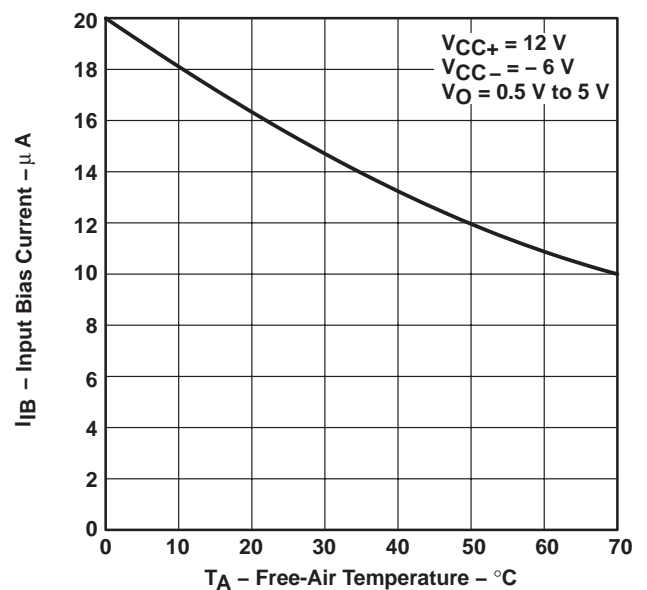

Figure 2

LM306 DIFFERENTIAL COMPARATOR WITH STROBES

SLCS008A – OCTOBER 1979 – REVISED OCTOBER 1991

TYPICAL CHARACTERISTICS

HIGH-LEVEL OUTPUT VOLTAGE
vs
FREE-AIR TEMPERATURE

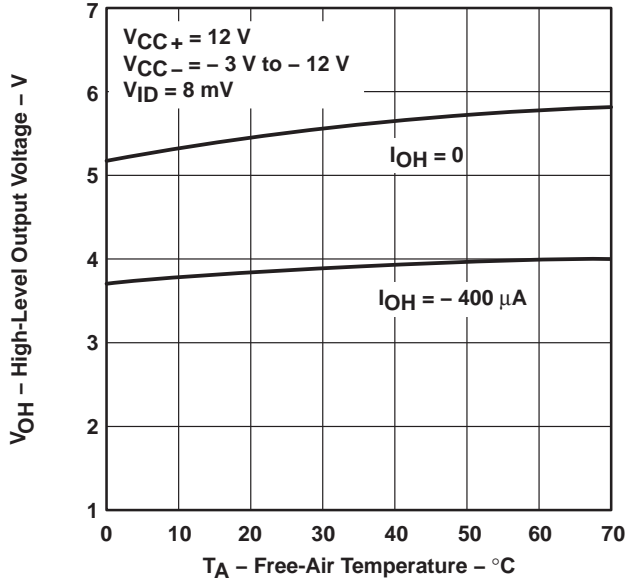

Figure 3

LOW-LEVEL OUTPUT VOLTAGE
vs
FREE-AIR TEMPERATURE

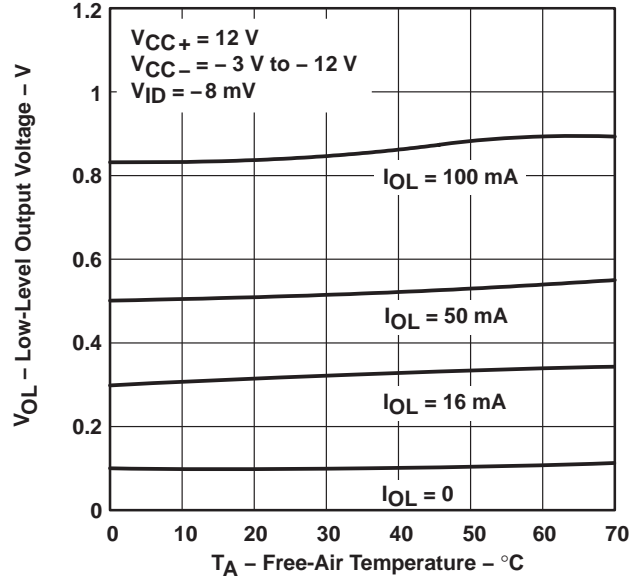

Figure 4

OUTPUT VOLTAGE
vs
DIFFERENTIAL INPUT VOLTAGE

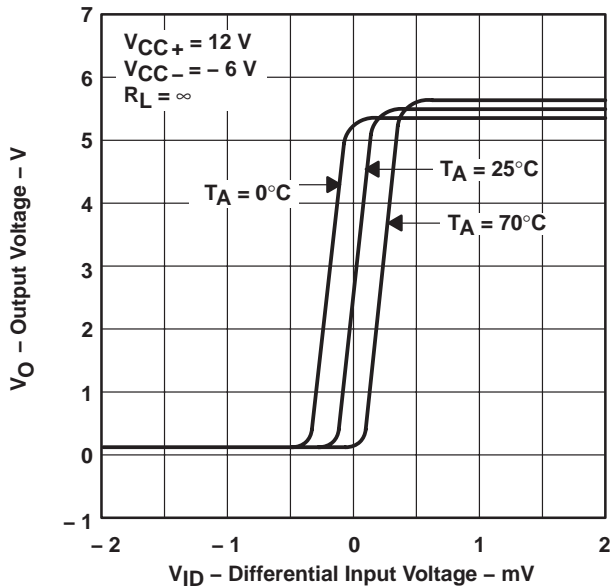

Figure 5

OUTPUT CURRENT
vs
DIFFERENTIAL INPUT VOLTAGE

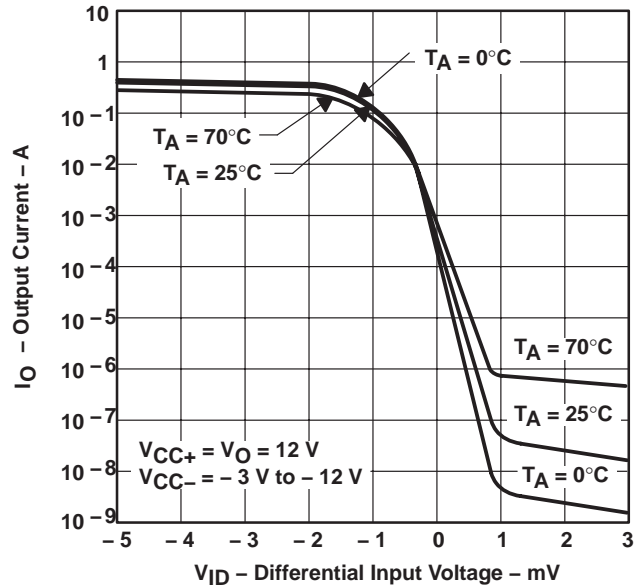

Figure 6



TYPICAL CHARACTERISTICS

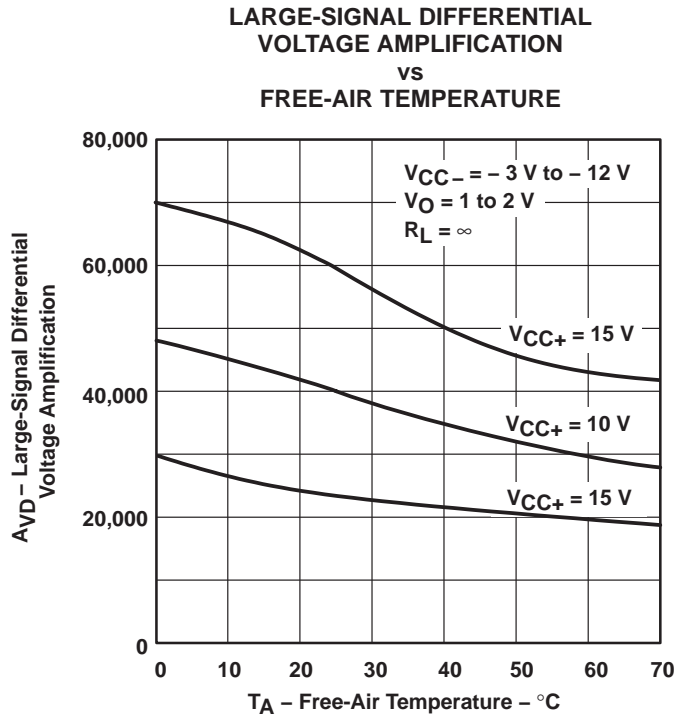
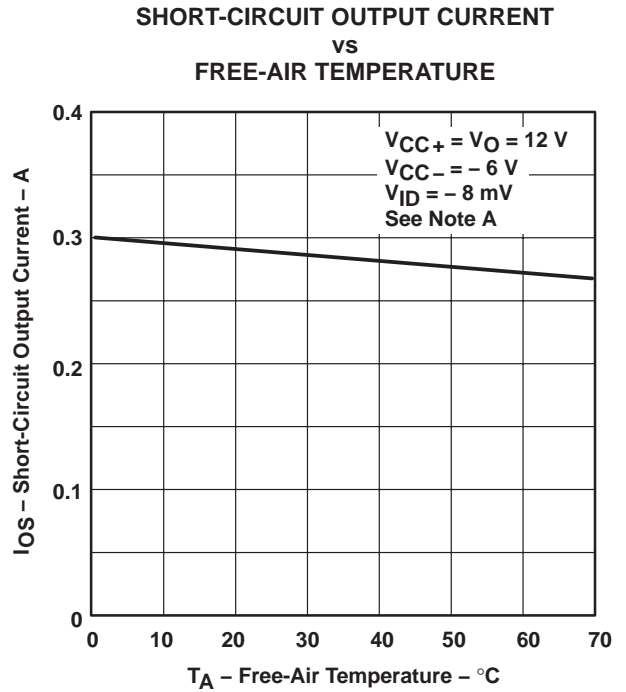

Figure 7



NOTE A: This parameter was measured using a single 5-ms pulse.

Figure 8

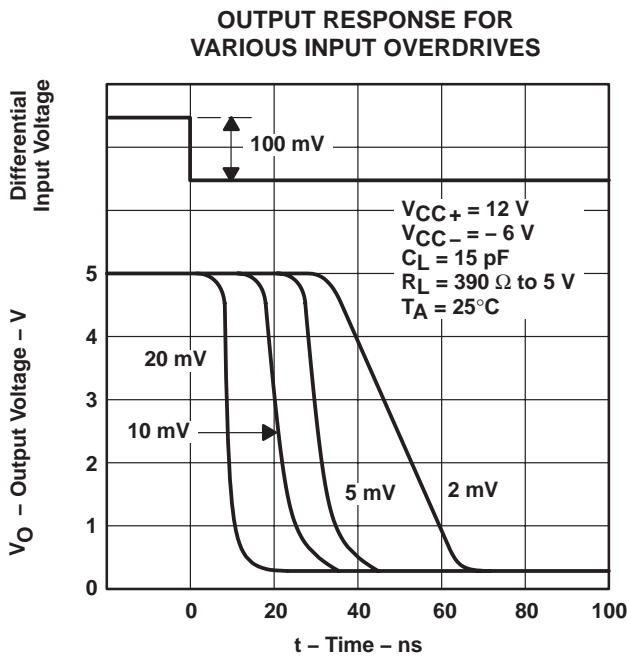

Figure 9

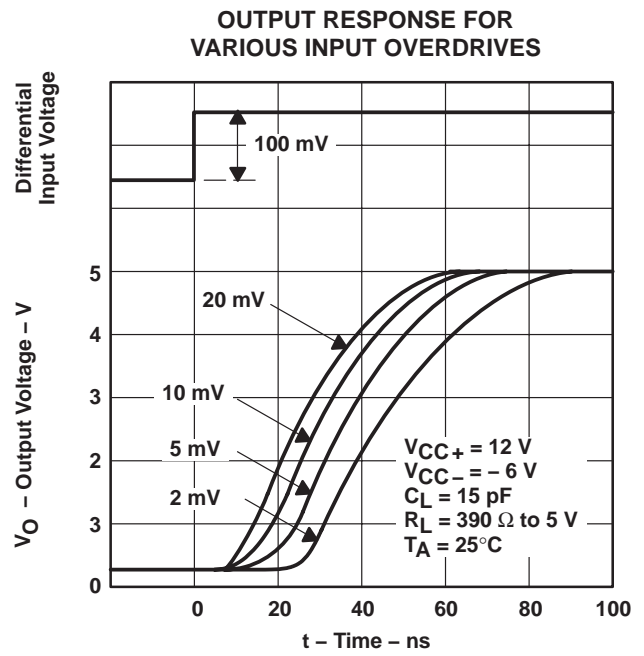

Figure 10

LM306 DIFFERENTIAL COMPARATOR WITH STROBES

SLCS008A – OCTOBER 1979 – REVISED OCTOBER 1991

TYPICAL CHARACTERISTICS

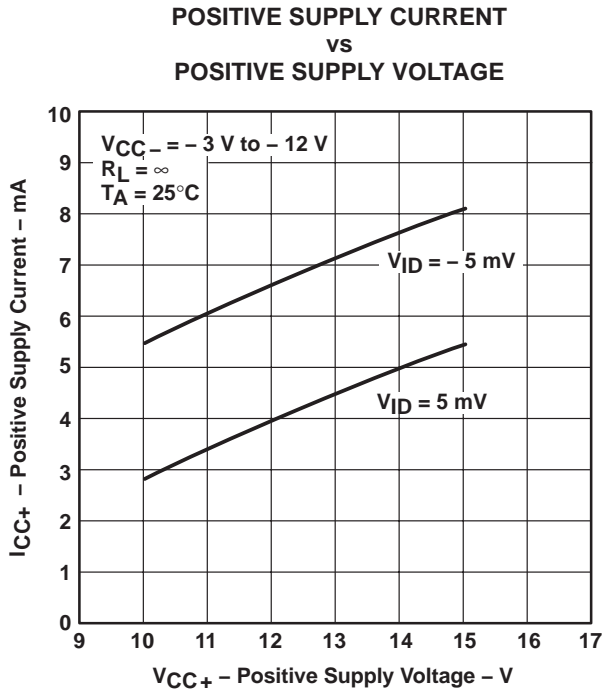

Figure 11

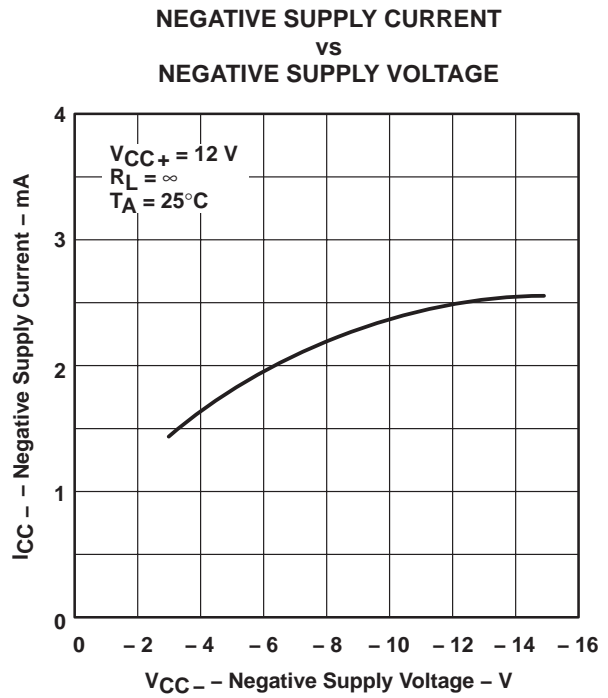

Figure 12

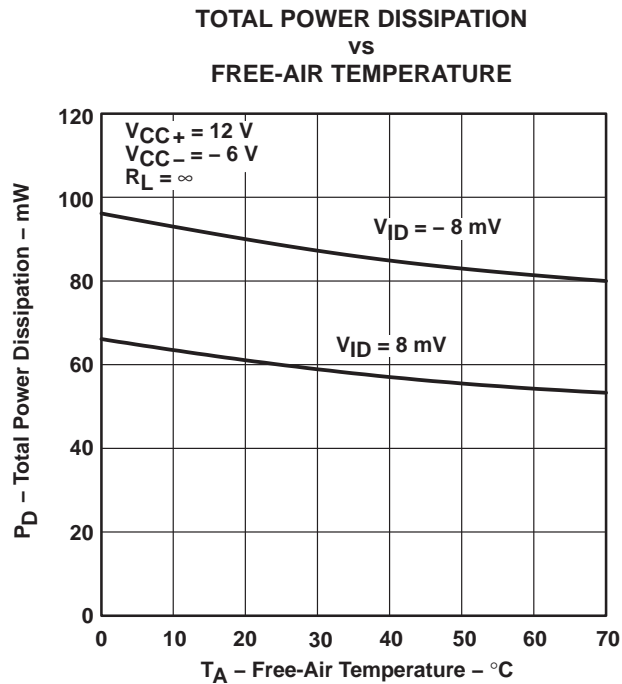

Figure 13



PACKAGING INFORMATION

Orderable Device	Status ⁽¹⁾	Package Type	Package Drawing	Pins	Package Qty	Eco Plan ⁽²⁾	Lead/ Ball Finish	MSL Peak Temp ⁽³⁾	Samples (Requires Login)
LM306D	ACTIVE	SOIC	D	8	75	Green (RoHS & no Sb/Br)	CU NIPDAU	Level-1-260C-UNLIM	
LM306DE4	ACTIVE	SOIC	D	8	75	Green (RoHS & no Sb/Br)	CU NIPDAU	Level-1-260C-UNLIM	
LM306DG4	ACTIVE	SOIC	D	8	75	Green (RoHS & no Sb/Br)	CU NIPDAU	Level-1-260C-UNLIM	
LM306DR	OBSOLETE	SOIC	D	8		TBD	Call TI	Call TI	
LM306DRE4	OBSOLETE	SOIC	D	8		TBD	Call TI	Call TI	
LM306DRG4	OBSOLETE	SOIC	D	8		TBD	Call TI	Call TI	
LM306P	ACTIVE	PDIP	P	8	50	Pb-Free (RoHS)	CU NIPDAU	N / A for Pkg Type	
LM306PE4	ACTIVE	PDIP	P	8	50	Pb-Free (RoHS)	CU NIPDAU	N / A for Pkg Type	

⁽¹⁾ The marketing status values are defined as follows:

ACTIVE: Product device recommended for new designs.

LIFEBUY: TI has announced that the device will be discontinued, and a lifetime-buy period is in effect.

NRND: Not recommended for new designs. Device is in production to support existing customers, but TI does not recommend using this part in a new design.

PREVIEW: Device has been announced but is not in production. Samples may or may not be available.

OBSOLETE: TI has discontinued the production of the device.

⁽²⁾ Eco Plan - The planned eco-friendly classification: Pb-Free (RoHS), Pb-Free (RoHS Exempt), or Green (RoHS & no Sb/Br) - please check <http://www.ti.com/productcontent> for the latest availability information and additional product content details.

TBD: The Pb-Free/Green conversion plan has not been defined.

Pb-Free (RoHS): TI's terms "Lead-Free" or "Pb-Free" mean semiconductor products that are compatible with the current RoHS requirements for all 6 substances, including the requirement that lead not exceed 0.1% by weight in homogeneous materials. Where designed to be soldered at high temperatures, TI Pb-Free products are suitable for use in specified lead-free processes.

Pb-Free (RoHS Exempt): This component has a RoHS exemption for either 1) lead-based flip-chip solder bumps used between the die and package, or 2) lead-based die adhesive used between the die and leadframe. The component is otherwise considered Pb-Free (RoHS compatible) as defined above.

Green (RoHS & no Sb/Br): TI defines "Green" to mean Pb-Free (RoHS compatible), and free of Bromine (Br) and Antimony (Sb) based flame retardants (Br or Sb do not exceed 0.1% by weight in homogeneous material)

⁽³⁾ MSL, Peak Temp. -- The Moisture Sensitivity Level rating according to the JEDEC industry standard classifications, and peak solder temperature.

Important Information and Disclaimer: The information provided on this page represents TI's knowledge and belief as of the date that it is provided. TI bases its knowledge and belief on information provided by third parties, and makes no representation or warranty as to the accuracy of such information. Efforts are underway to better integrate information from third parties. TI has taken and continues to take reasonable steps to provide representative and accurate information but may not have conducted destructive testing or chemical analysis on incoming materials and chemicals. TI and TI suppliers consider certain information to be proprietary, and thus CAS numbers and other limited information may not be available for release.



www.ti.com

28-Aug-2012

In no event shall TI's liability arising out of such information exceed the total purchase price of the TI part(s) at issue in this document sold by TI to Customer on an annual basis.

P (R-PDIP-T8)

PLASTIC DUAL-IN-LINE PACKAGE

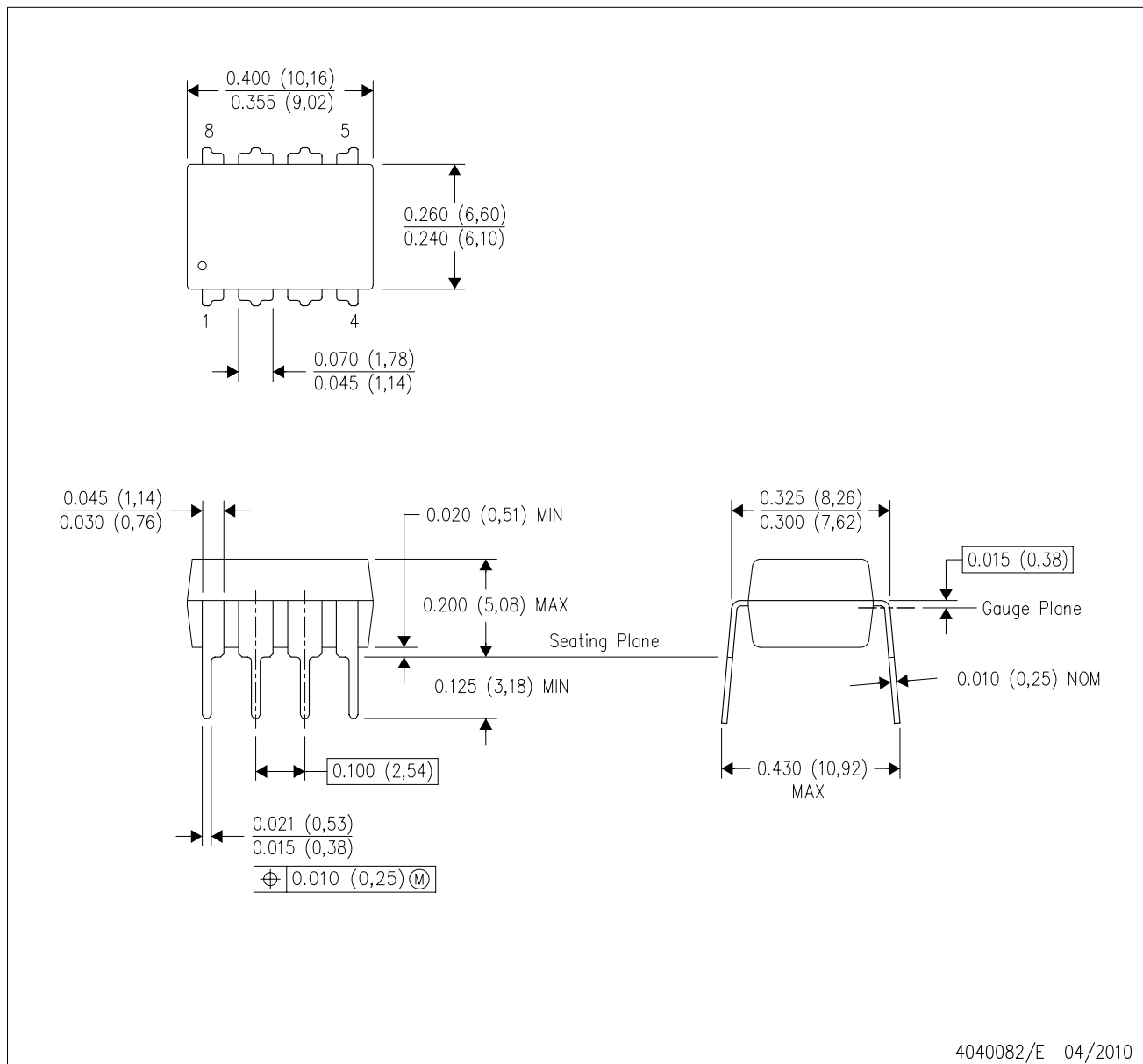

- NOTES:
- A. All linear dimensions are in inches (millimeters).
 - B. This drawing is subject to change without notice.
 - C. Falls within JEDEC MS-001 variation BA.

D (R-PDSO-G8)

PLASTIC SMALL OUTLINE



D (R-PDSO-G8)

PLASTIC SMALL OUTLINE

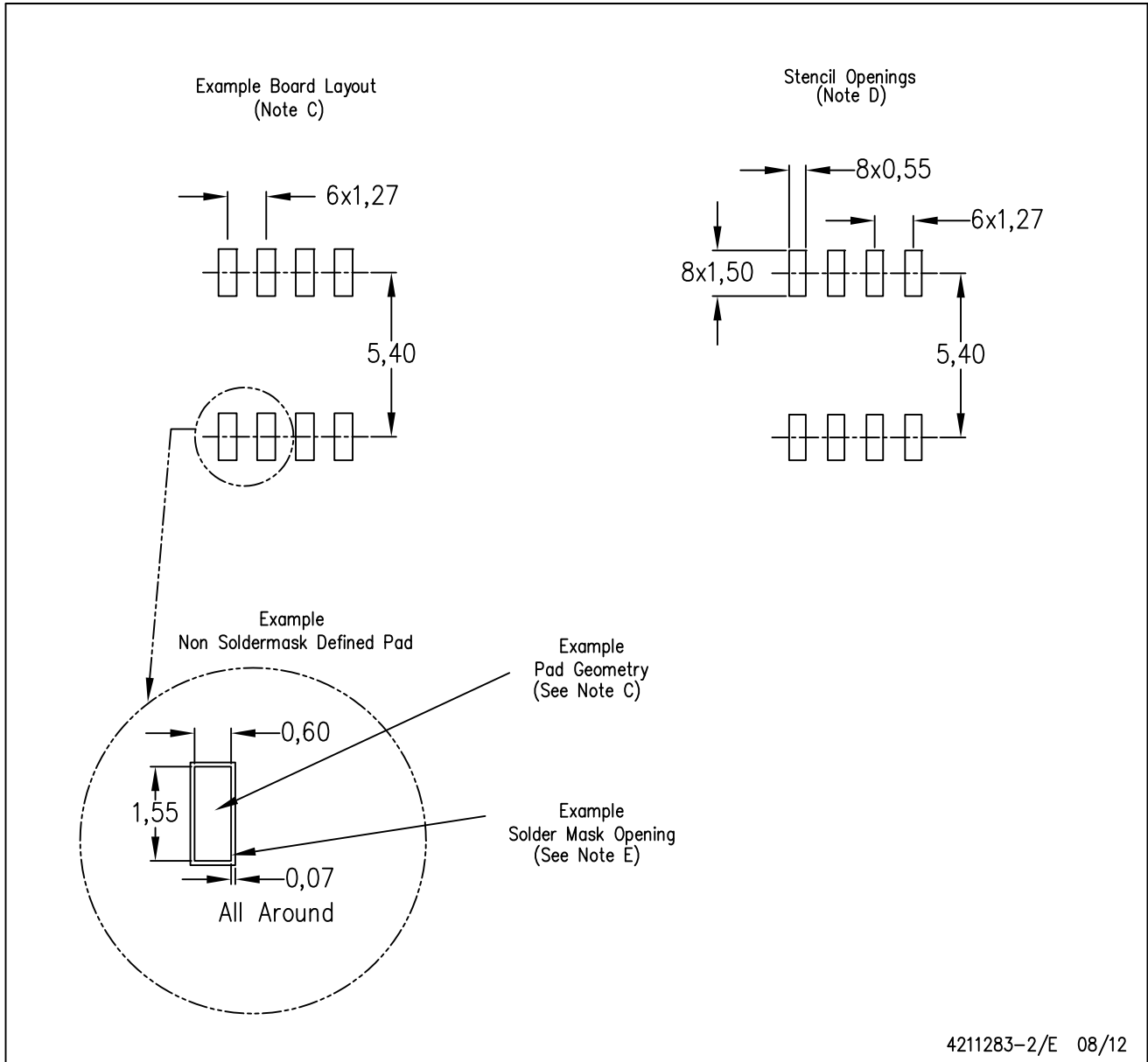

- NOTES:
- All linear dimensions are in millimeters.
 - This drawing is subject to change without notice.
 - Publication IPC-7351 is recommended for alternate designs.
 - Laser cutting apertures with trapezoidal walls and also rounding corners will offer better paste release. Customers should contact their board assembly site for stencil design recommendations. Refer to IPC-7525 for other stencil recommendations.
 - Customers should contact their board fabrication site for solder mask tolerances between and around signal pads.

IMPORTANT NOTICE

Texas Instruments Incorporated and its subsidiaries (TI) reserve the right to make corrections, enhancements, improvements and other changes to its semiconductor products and services per JESD46C and to discontinue any product or service per JESD48B. Buyers should obtain the latest relevant information before placing orders and should verify that such information is current and complete. All semiconductor products (also referred to herein as "components") are sold subject to TI's terms and conditions of sale supplied at the time of order acknowledgment.

TI warrants performance of its components to the specifications applicable at the time of sale, in accordance with the warranty in TI's terms and conditions of sale of semiconductor products. Testing and other quality control techniques are used to the extent TI deems necessary to support this warranty. Except where mandated by applicable law, testing of all parameters of each component is not necessarily performed.

TI assumes no liability for applications assistance or the design of Buyers' products. Buyers are responsible for their products and applications using TI components. To minimize the risks associated with Buyers' products and applications, Buyers should provide adequate design and operating safeguards.

TI does not warrant or represent that any license, either express or implied, is granted under any patent right, copyright, mask work right, or other intellectual property right relating to any combination, machine, or process in which TI components or services are used. Information published by TI regarding third-party products or services does not constitute a license to use such products or services or a warranty or endorsement thereof. Use of such information may require a license from a third party under the patents or other intellectual property of the third party, or a license from TI under the patents or other intellectual property of TI.

Reproduction of significant portions of TI information in TI data books or data sheets is permissible only if reproduction is without alteration and is accompanied by all associated warranties, conditions, limitations, and notices. TI is not responsible or liable for such altered documentation. Information of third parties may be subject to additional restrictions.

Resale of TI components or services with statements different from or beyond the parameters stated by TI for that component or service voids all express and any implied warranties for the associated TI component or service and is an unfair and deceptive business practice. TI is not responsible or liable for any such statements.

Buyer acknowledges and agrees that it is solely responsible for compliance with all legal, regulatory and safety-related requirements concerning its products, and any use of TI components in its applications, notwithstanding any applications-related information or support that may be provided by TI. Buyer represents and agrees that it has all the necessary expertise to create and implement safeguards which anticipate dangerous consequences of failures, monitor failures and their consequences, lessen the likelihood of failures that might cause harm and take appropriate remedial actions. Buyer will fully indemnify TI and its representatives against any damages arising out of the use of any TI components in safety-critical applications.

In some cases, TI components may be promoted specifically to facilitate safety-related applications. With such components, TI's goal is to help enable customers to design and create their own end-product solutions that meet applicable functional safety standards and requirements. Nonetheless, such components are subject to these terms.

No TI components are authorized for use in FDA Class III (or similar life-critical medical equipment) unless authorized officers of the parties have executed a special agreement specifically governing such use.

Only those TI components which TI has specifically designated as military grade or "enhanced plastic" are designed and intended for use in military/aerospace applications or environments. Buyer acknowledges and agrees that any military or aerospace use of TI components which have **not** been so designated is solely at the Buyer's risk, and that Buyer is solely responsible for compliance with all legal and regulatory requirements in connection with such use.

TI has specifically designated certain components which meet ISO/TS16949 requirements, mainly for automotive use. Components which have not been so designated are neither designed nor intended for automotive use; and TI will not be responsible for any failure of such components to meet such requirements.

Products

Audio	www.ti.com/audio
Amplifiers	amplifier.ti.com
Data Converters	dataconverter.ti.com
DLP® Products	www.dlp.com
DSP	dsp.ti.com
Clocks and Timers	www.ti.com/clocks
Interface	interface.ti.com
Logic	logic.ti.com
Power Mgmt	power.ti.com
Microcontrollers	microcontroller.ti.com
RFID	www.ti-rfid.com
OMAP Mobile Processors	www.ti.com/omap
Wireless Connectivity	www.ti.com/wirelessconnectivity

Applications

Automotive and Transportation	www.ti.com/automotive
Communications and Telecom	www.ti.com/communications
Computers and Peripherals	www.ti.com/computers
Consumer Electronics	www.ti.com/consumer-apps
Energy and Lighting	www.ti.com/energy
Industrial	www.ti.com/industrial
Medical	www.ti.com/medical
Security	www.ti.com/security
Space, Avionics and Defense	www.ti.com/space-avionics-defense
Video and Imaging	www.ti.com/video

TI E2E Community e2e.ti.com