

# BZX84BxxxLT1G, BZX84CxxxLT1G Series, SZBZX84BxxxLT1G, SZBZX84CxxxLT1G Series



ON Semiconductor®

<http://onsemi.com>

## Zener Voltage Regulators

### 225 mW SOT-23 Surface Mount

This series of Zener diodes is offered in the convenient, surface mount plastic SOT-23 package. These devices are designed to provide voltage regulation with minimum space requirement. They are well suited for applications such as cellular phones, hand held portables, and high density PC boards.

#### Features

- 225 mW Rating on FR-4 or FR-5 Board
- Zener Breakdown Voltage Range – 2.4 V to 75 V
- Package Designed for Optimal Automated Board Assembly
- Small Package Size for High Density Applications
- ESD Rating of Class 3 (> 16 kV) per Human Body Model
- Tight Tolerance Series Available (See Page 4)
- AEC-Q101 Qualified and PPAP Capable
- SZ Prefix for Automotive and Other Applications Requiring Unique Site and Control Change Requirements
- Pb-Free Packages are Available

#### Mechanical Characteristics

**CASE:** Void-free, transfer-molded, thermosetting plastic case

**FINISH:** Corrosion resistant finish, easily Solderable

**MAXIMUM CASE TEMPERATURE FOR SOLDERING PURPOSES:**  
260°C for 10 Seconds

**POLARITY:** Cathode indicated by polarity band

**FLAMMABILITY RATING:** UL 94 V-0

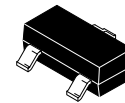

SOT-23  
CASE 318  
STYLE 8

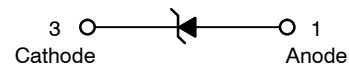

#### MARKING DIAGRAM

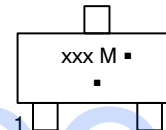

xxx = Device Code  
M = Date Code\*  
▪ = Pb-Free Package

(Note: Microdot may be in either location)

\*Date Code orientation may vary depending upon manufacturing location.

#### ORDERING INFORMATION

Device	Package	Shipping†
BZX84CxxxLT1G	SOT-23 (Pb-Free)	3,000 / Tape & Reel
SZBZX84xxxLT1G	SOT-23 (Pb-Free)	3,000 / Tape & Reel
BZX84CxxxLT3G	SOT-23 (Pb-Free)	10,000 / Tape & Reel
SZBZX84xxxLT3G	SOT-23 (Pb-Free)	10,000 / Tape & Reel
BZX84BxxxLT1G	SOT-23 (Pb-Free)	3,000 / Tape & Reel
SZBZX84BxxxLT1G	SOT-23 (Pb-Free)	3,000 / Tape & Reel
BZX84BxxxLT3G	SOT-23 (Pb-Free)	10,000 / Tape & Reel

†For information on tape and reel specifications, including part orientation and tape sizes, please refer to our Tape and Reel Packaging Specification Brochure, BRD8011/D.

#### DEVICE MARKING INFORMATION

See specific marking information in the device marking column of the Electrical Characteristics table on page 3 of this data sheet.

\*For additional information on our Pb-Free strategy and soldering details, please download the ON Semiconductor Soldering and Mounting Techniques Reference Manual, SOLDERRM/D.

# BZX84BxxxLT1G, BZX84CxxxLT1G Series, SZBZX84BxxxLT1G, SZBZX84CxxxLT1G Series

## MAXIMUM RATINGS

Rating	Symbol	Max	Unit
Total Power Dissipation on FR-5 Board, (Note 1) @ $T_A = 25^\circ\text{C}$ Derated above $25^\circ\text{C}$	$P_D$	225	mW
Thermal Resistance, Junction-to-Ambient	$R_{\theta JA}$	1.8 556	$\text{mW}/^\circ\text{C}$ $^\circ\text{C}/\text{W}$
Total Power Dissipation on Alumina Substrate, (Note 2) @ $T_A = 25^\circ\text{C}$ Derated above $25^\circ\text{C}$	$P_D$	300	mW
Thermal Resistance, Junction-to-Ambient	$R_{\theta JA}$	2.4 417	$\text{mW}/^\circ\text{C}$ $^\circ\text{C}/\text{W}$
Junction and Storage Temperature Range	$T_J, T_{stg}$	-65 to +150	$^\circ\text{C}$

Stresses exceeding Maximum Ratings may damage the device. Maximum Ratings are stress ratings only. Functional operation above the Recommended Operating Conditions is not implied. Extended exposure to stresses above the Recommended Operating Conditions may affect device reliability.

- FR-5 = 1.0 X 0.75 X 0.62 in.
- Alumina = 0.4 X 0.3 X 0.024 in., 99.5% alumina.

## ELECTRICAL CHARACTERISTICS

(Pinout: 1-Anode, 2-No Connection, 3-Cathode) ( $T_A = 25^\circ\text{C}$  unless otherwise noted,  $V_F = 0.90\text{ V Max.}$  @  $I_F = 10\text{ mA}$ )

Symbol	Parameter
$V_Z$	Reverse Zener Voltage @ $I_{ZT}$
$I_{ZT}$	Reverse Current
$Z_{ZT}$	Maximum Zener Impedance @ $I_{ZT}$
$I_R$	Reverse Leakage Current @ $V_R$
$V_R$	Reverse Voltage
$I_F$	Forward Current
$V_F$	Forward Voltage @ $I_F$
$\Theta V_Z$	Maximum Temperature Coefficient of $V_Z$
C	Max. Capacitance @ $V_R = 0$ and $f = 1\text{ MHz}$

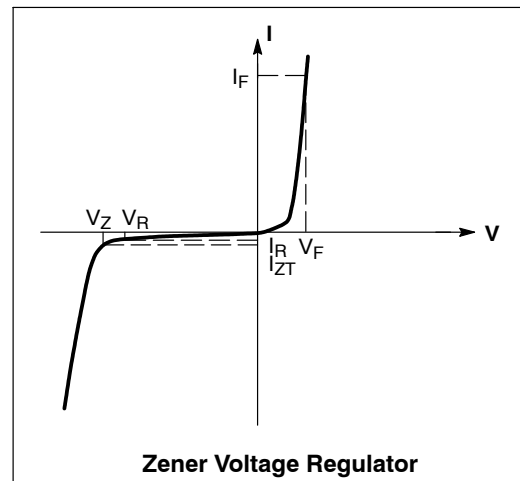

# BZX84BxxxLT1G, BZX84CxxxLT1G Series, SZBZX84BxxxLT1G, SZBZX84CxxxLT1G Series

## ELECTRICAL CHARACTERISTICS – BZX84CxxxLT1 SERIES (STANDARD TOLERANCE)

(Pinout: 1-Anode, 2-No Connection, 3-Cathode) (T<sub>A</sub> = 25°C unless otherwise noted, V<sub>F</sub> = 0.90 V Max. @ I<sub>F</sub> = 10 mA)  
 (Devices listed in **bold, italic** are ON Semiconductor Preferred devices.)

Device*	Device Marking	V <sub>Z1</sub> (Volts) @ I <sub>ZT1</sub> = 5 mA (Note 3)			Z <sub>ZT1</sub> (Ω) @ I <sub>ZT1</sub> = 5 mA	V <sub>Z2</sub> (V) @ I <sub>ZT2</sub> = 1 mA (Note 3)		Z <sub>ZT2</sub> (Ω) @ I <sub>ZT2</sub> = 1 mA	V <sub>Z3</sub> (V) @ I <sub>ZT3</sub> = 20 mA (Note 3)		Z <sub>ZT3</sub> (Ω) @ I <sub>ZT3</sub> = 20 mA	Max Reverse Leakage Current		θ <sub>VZ</sub> (mV/k) @ I <sub>ZT1</sub> = 5 mA		C (pF) @ V <sub>R</sub> = 0 f = 1 MHz
		Min	Nom	Max		Min	Max		Min	Max		I <sub>R</sub> (μA)	V <sub>R</sub> (Volts)	Min	Max	
		Min	Nom	Max	Min	Max	Min	Max	Min	Max	I <sub>R</sub> (μA)	V <sub>R</sub> (Volts)	Min	Max		
BZX84C2V4LT1G	Z11	2.2	2.4	2.6	100	1.7	2.1	600	2.6	3.2	50	50	1	-3.5	0	450
BZX84C2V7LT1G	Z12	2.5	2.7	2.9	100	1.9	2.4	600	3	3.6	50	20	1	-3.5	0	450
BZX84C3V0LT1G	Z13	2.8	3	3.2	95	2.1	2.7	600	3.3	3.9	50	10	1	-3.5	0	450
BZX84C3V3LT1G	Z14	3.1	3.3	3.5	95	2.3	2.9	600	3.6	4.2	40	5	1	-3.5	0	450
BZX84C3V6LT1G	Z15	3.4	3.6	3.8	90	2.7	3.3	600	3.9	4.5	40	5	1	-3.5	0	450
BZX84C3V9LT1G	Z16	3.7	3.9	4.1	90	2.9	3.5	600	4.1	4.7	30	3	1	-3.5	-2.5	450
BZX84C4V3LT1G	W9	4	4.3	4.6	90	3.3	4	600	4.4	5.1	30	3	1	-3.5	0	450
<b>BZX84C4V7LT1/T3G</b>	<b>Z1</b>	<b>4.4</b>	<b>4.7</b>	<b>5</b>	<b>80</b>	<b>3.7</b>	<b>4.7</b>	<b>500</b>	<b>4.5</b>	<b>5.4</b>	<b>15</b>	<b>3</b>	<b>2</b>	<b>-3.5</b>	<b>0.2</b>	<b>260</b>
<b>BZX84C5V1LT1/T3G</b>	<b>Z2</b>	<b>4.8</b>	<b>5.1</b>	<b>5.4</b>	<b>60</b>	<b>4.2</b>	<b>5.3</b>	<b>480</b>	<b>5</b>	<b>5.9</b>	<b>15</b>	<b>2</b>	<b>2</b>	<b>-2.7</b>	<b>1.2</b>	<b>225</b>
<b>BZX84C5V6LT1/T3G</b>	<b>Z3</b>	<b>5.2</b>	<b>5.6</b>	<b>6</b>	<b>40</b>	<b>4.8</b>	<b>6</b>	<b>400</b>	<b>5.2</b>	<b>6.3</b>	<b>10</b>	<b>1</b>	<b>2</b>	<b>-2.0</b>	<b>2.5</b>	<b>200</b>
<b>BZX84C6V2LT1/T3G</b>	<b>Z4</b>	<b>5.8</b>	<b>6.2</b>	<b>6.6</b>	<b>10</b>	<b>5.6</b>	<b>6.6</b>	<b>150</b>	<b>5.8</b>	<b>6.8</b>	<b>6</b>	<b>3</b>	<b>4</b>	<b>0.4</b>	<b>3.7</b>	<b>185</b>
BZX84C6V8LT1/T3G	Z5	6.4	6.8	7.2	15	6.3	7.2	80	6.4	7.4	6	2	4	1.2	4.5	155
BZX84C7V5LT1G	Z6	7	7.5	7.9	15	6.9	7.9	80	7	8	6	1	5	2.5	5.3	140
BZX84C8V2LT1G	Z7	7.7	8.2	8.7	15	7.6	8.7	80	7.7	8.8	6	0.7	5	3.2	6.2	135
BZX84C9V1LT1/T3G	Z8	8.5	9.1	9.6	15	8.4	9.6	100	8.5	9.7	8	0.5	6	3.8	7.0	130
BZX84C10LT1G	Z9	9.4	10	10.6	20	9.3	10.6	150	9.4	10.7	10	0.2	7	4.5	8.0	130
BZX84C11LT1G	Y1	10.4	11	11.6	20	10.2	11.6	150	10.4	11.8	10	0.1	8	5.4	9.0	130
<b>BZX84C12LT1G</b>	<b>Y2</b>	<b>11.4</b>	<b>12</b>	<b>12.7</b>	<b>25</b>	<b>11.2</b>	<b>12.7</b>	<b>150</b>	<b>11.4</b>	<b>12.9</b>	<b>10</b>	<b>0.1</b>	<b>8</b>	<b>6.0</b>	<b>10.0</b>	<b>130</b>
BZX84C13LT1G	Y3	12.4	13	14.1	30	12.3	14	170	12.5	14.2	15	0.1	8	7.0	11.0	120
BZX84C15LT1/T3G	Y4	13.8	15	15.6	30	13.7	15.5	200	13.9	15.7	20	0.05	10.5	9.2	13.0	110
BZX84C16LT1G	Y5	15.3	16	17.1	40	15.2	17	200	15.4	17.2	20	0.05	11.2	10.4	14.0	105
<b>BZX84C18LT1/T3G</b>	<b>Y6</b>	<b>16.8</b>	<b>18</b>	<b>19.1</b>	<b>45</b>	<b>16.7</b>	<b>19</b>	<b>225</b>	<b>16.9</b>	<b>19.2</b>	<b>20</b>	<b>0.05</b>	<b>12.6</b>	<b>12.4</b>	<b>16.0</b>	<b>100</b>
BZX84C20LT1G	Y7	18.8	20	21.2	55	18.7	21.1	225	18.9	21.4	20	0.05	14	14.4	18.0	85
BZX84C22LT1G	Y8	20.8	22	23.3	55	20.7	23.2	250	20.9	23.4	25	0.05	15.4	16.4	20.0	85
BZX84C24LT1G	Y9	22.8	24	25.6	70	22.7	25.5	250	22.9	25.7	25	0.05	16.8	18.4	22.0	80
Device*	Device Marking	V <sub>Z1</sub> Below @ I <sub>ZT1</sub> = 2 mA			Z <sub>ZT1</sub> Below @ I <sub>ZT1</sub> = 2 mA	V <sub>Z2</sub> Below @ I <sub>ZT2</sub> = 0.1 mA		Z <sub>ZT2</sub> Below @ I <sub>ZT2</sub> = 0.5 mA	V <sub>Z3</sub> Below @ I <sub>ZT3</sub> = 10 mA		Z <sub>ZT3</sub> Below @ I <sub>ZT3</sub> = 10 mA	Max Reverse Leakage Current		θ <sub>VZ</sub> (mV/k) Below @ I <sub>ZT1</sub> = 2 mA		C (pF) @ V <sub>R</sub> = 0 f = 1 MHz
		Min	Nom	Max		Min	Max		Min	Max		I <sub>R</sub> (μA)	V <sub>R</sub> (V)	Min	Max	
		Min	Nom	Max	Min	Max	Min	Max	Min	Max	I <sub>R</sub> (μA)	V <sub>R</sub> (V)	Min	Max		
BZX84C27LT1G	Y10	25.1	27	28.9	80	25	28.9	300	25.2	29.3	45	0.05	18.9	21.4	25.3	70
BZX84C30LT1G	Y11	28	30	32	80	27.8	32	300	28.1	32.4	50	0.05	21	24.4	29.4	70
BZX84C33LT1/T3G	Y12	31	33	35	80	30.8	35	325	31.1	35.4	55	0.05	23.1	27.4	33.4	70
BZX84C36LT1G	Y13	34	36	38	90	33.8	38	350	34.1	38.4	60	0.05	25.2	30.4	37.4	70
BZX84C39LT1G	Y14	37	39	41	130	36.7	41	350	37.1	41.5	70	0.05	27.3	33.4	41.2	45
BZX84C43LT1G	Y15	40	43	46	150	39.7	46	375	40.1	46.5	80	0.05	30.1	37.6	46.6	40
BZX84C47LT1G	Y16	44	47	50	170	43.7	50	375	44.1	50.5	90	0.05	32.9	42.0	51.8	40
BZX84C51LT1G	Y17	48	51	54	180	47.6	54	400	48.1	54.6	100	0.05	35.7	46.6	57.2	40
BZX84C56LT1G	Y18	52	56	60	200	51.5	60	425	52.1	60.8	110	0.05	39.2	52.2	63.8	40
BZX84C62LT1G	Y19	58	62	66	215	57.4	66	450	58.2	67	120	0.05	43.4	58.8	71.6	35
BZX84C68LT1G	Y20	64	68	72	240	63.4	72	475	64.2	73.2	130	0.05	47.6	65.6	79.8	35
BZX84C75LT1G	Y21	70	75	79	255	69.4	79	500	70.3	80.2	140	0.05	52.5	73.4	88.6	35

3. Zener voltage is measured with a pulse test current I<sub>Z</sub> at an ambient temperature of 25°C.

\*Include SZ-prefix devices where applicable.

# BZX84BxxxLT1G, BZX84CxxxLT1G Series, SZBZX84BxxxLT1G, SZBZX84CxxxLT1G Series

## ELECTRICAL CHARACTERISTICS – BZX84BxxxL (Tight Tolerance Series)

(Pinout: 1-Anode, 2-No Connection, 3-Cathode) ( $T_A = 25^\circ\text{C}$  unless otherwise noted,  $V_F = 0.90\text{ V Max.}$  @  $I_F = 10\text{ mA}$ )

Device*	Device Marking	V <sub>Z</sub> (Volts) @ I <sub>ZT</sub> = 5 mA (Note 4)			Z <sub>ZT</sub> (Ω) @ I <sub>ZT</sub> = 5 mA (Note 4)	Max Reverse Leakage Current		θ <sub>vZ</sub> (mV/k) @ I <sub>ZT</sub> = 5 mA		C (pF) @ V <sub>R</sub> = 0, f = 1 MHz
		Min	Nom	Max		I <sub>R</sub>	V <sub>R</sub>	Min	Max	
					Max	μA	@ Volts			
BZX84B4V7LT1G	T10	4.61	4.7	4.79	80	3	2	-3.5	0.2	260
BZX84B5V1LT1G	T11	5.00	5.1	5.20	60	2	2	-2.7	1.2	225
BZX84B5V6LT1G	T12	5.49	5.6	5.71	40	1	2	-2	2.5	200
BZX84B6V2LT1G	T13	6.08	6.2	6.32	10	3	4	0.4	3.7	185
BZX84B6V8LT1G	T14	6.66	6.8	6.94	15	2	4	1.2	4.5	155
BZX84B7V5LT1G	T15	7.35	7.5	7.65	15	1	5	2.5	5.3	140
BZX84B8V2LT1G	T16	8.04	8.2	8.36	15	0.7	5	3.2	6.2	135
BZX84B9V1LT1G	T17	8.92	9.1	9.28	15	0.5	6	3.8	7	130
BZX84B12LT1G	T18	11.8	12	12.2	25	0.1	8	6	10	130
BZX84B15LT1G	T22	14.7	15	15.3	30	0.05	10.5	9.2	13	110
BZX84B16LT1G	T19	15.7	16	16.3	40	0.05	11.2	10.4	14	105
BZX84B18LT1G	T20	17.6	18	18.4	45	0.05	12.6	12.4	16	100
BZX84B22LT1G	T24	21.6	22	22.4	55	0.05	15.4	16.4	20	85
BZX84B24LT1G	T25	23.5	24	24.5	70	0.05	16.8	18.4	22	80

4. Zener voltage is measured with a pulse test current I<sub>Z</sub> at an ambient temperature of 25°C.

\*Include SZ-prefix devices where applicable.

**BZX84BxxxLT1G, BZX84CxxxLT1G Series, SZBZX84BxxxLT1G, SZBZX84CxxxLT1G Series**

**TYPICAL CHARACTERISTICS**

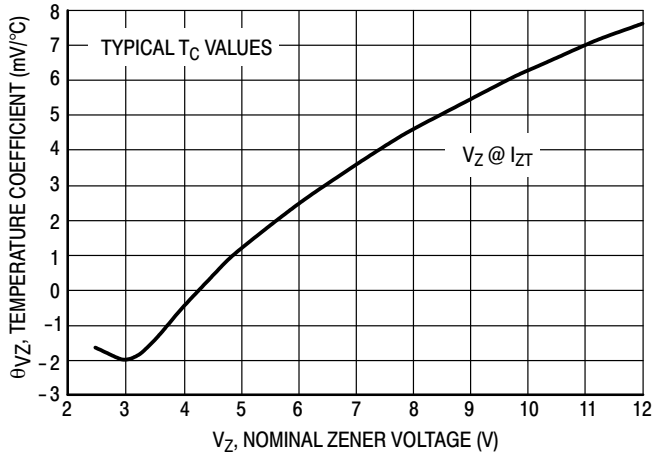

**Figure 1. Temperature Coefficients (Temperature Range -55°C to +150°C)**

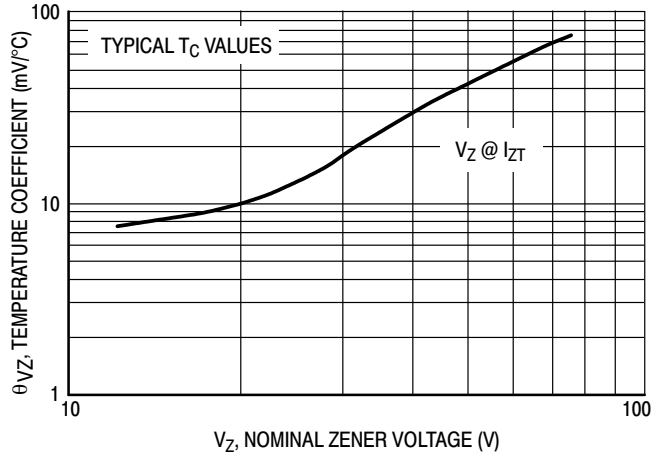

**Figure 2. Temperature Coefficients (Temperature Range -55°C to +150°C)**

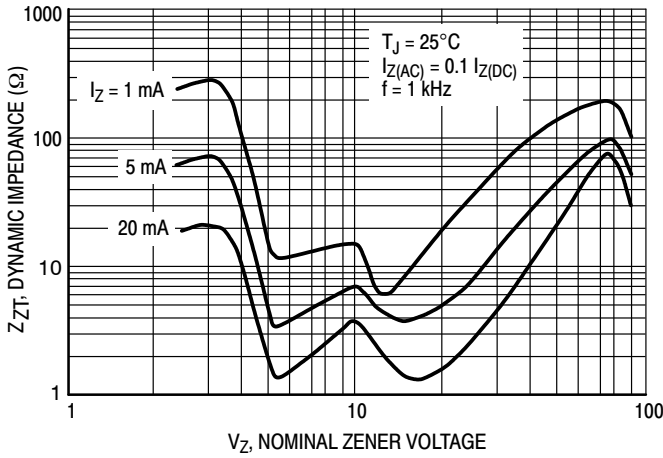

**Figure 3. Effect of Zener Voltage on Zener Impedance**

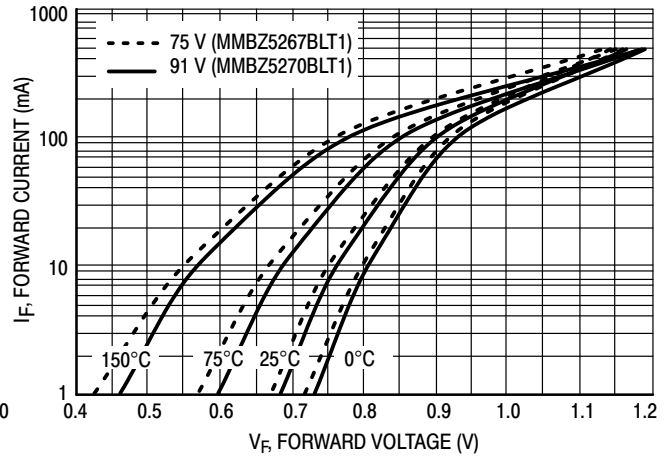

**Figure 4. Typical Forward Voltage**

**BZX84BxxxLT1G, BZX84CxxxLT1G Series, SZBZX84BxxxLT1G, SZBZX84CxxxLT1G Series**

**TYPICAL CHARACTERISTICS**

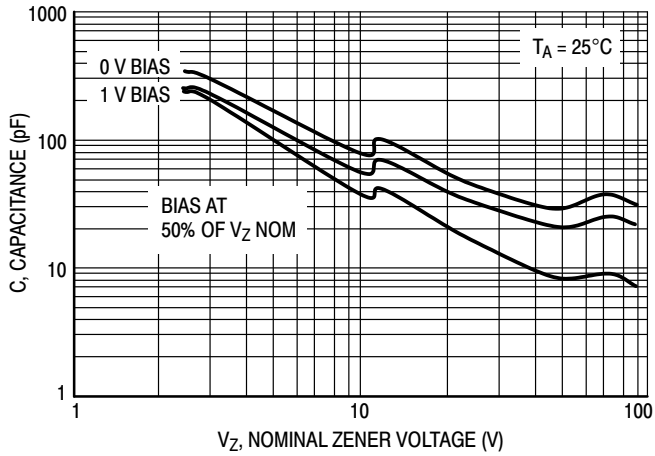

**Figure 5. Typical Capacitance**

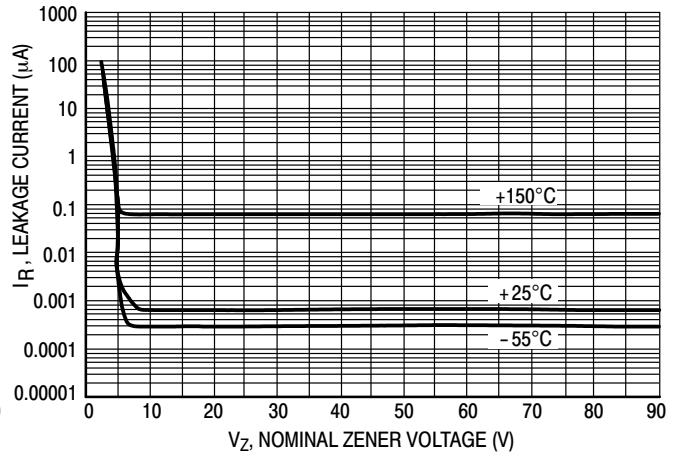

**Figure 6. Typical Leakage Current**

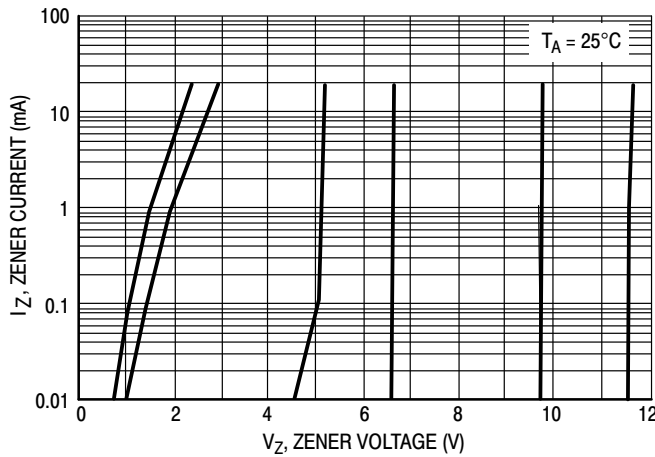

**Figure 7. Zener Voltage versus Zener Current  
( $V_Z$  Up to 12 V)**

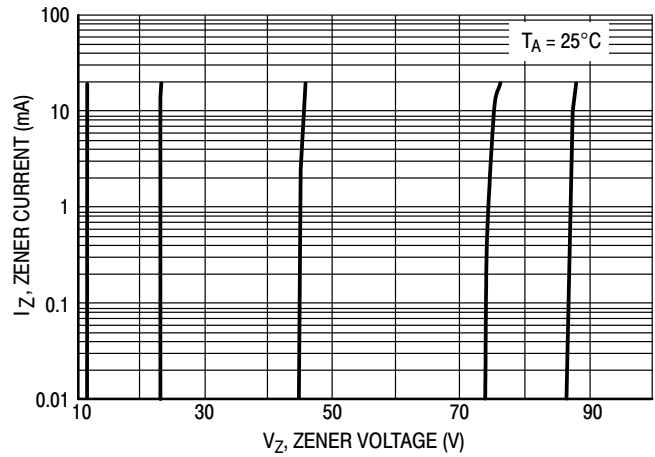

**Figure 8. Zener Voltage versus Zener Current  
(12 V to 91 V)**

# BZX84BxxxLT1G, BZX84CxxxLT1G Series, SZBZX84BxxxLT1G, SZBZX84CxxxLT1G Series

## PACKAGE DIMENSIONS

SOT-23 (TO-236)

CASE 318-08

ISSUE AP

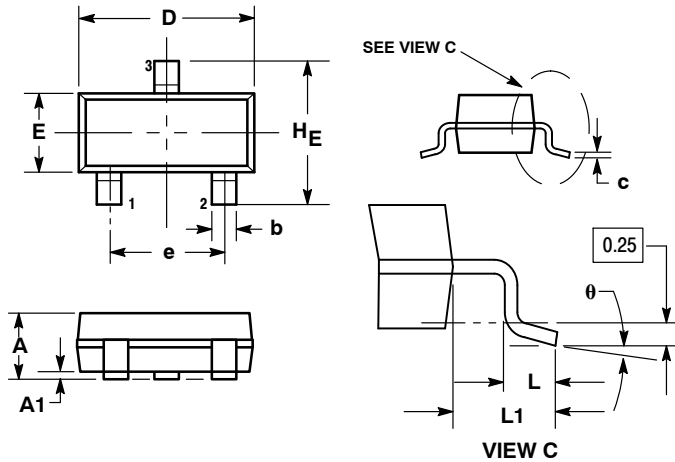

NOTES:

1. DIMENSIONING AND TOLERANCING PER ANSI Y14.5M, 1982.
2. CONTROLLING DIMENSION: INCH.
3. MAXIMUM LEAD THICKNESS INCLUDES LEAD FINISH THICKNESS. MINIMUM LEAD THICKNESS IS THE MINIMUM THICKNESS OF BASE MATERIAL.
4. DIMENSIONS D AND E DO NOT INCLUDE MOLD FLASH, PROTRUSIONS, OR GATE BURRS.

DIM	MILLIMETERS			INCHES		
	MIN	NOM	MAX	MIN	NOM	MAX
A	0.89	1.00	1.11	0.035	0.040	0.044
A1	0.01	0.06	0.10	0.001	0.002	0.004
b	0.37	0.44	0.50	0.015	0.018	0.020
c	0.09	0.13	0.18	0.003	0.005	0.007
D	2.80	2.90	3.04	0.110	0.114	0.120
E	1.20	1.30	1.40	0.047	0.051	0.055
e	1.78	1.90	2.04	0.070	0.075	0.081
L	0.10	0.20	0.30	0.004	0.008	0.012
L1	0.35	0.54	0.69	0.014	0.021	0.029
HE	2.10	2.40	2.64	0.083	0.094	0.104
θ	0°	---	10°	0°	---	10°

STYLE 8:

1. ANODE
2. NO CONNECTION
3. CATHODE

### SOLDERING FOOTPRINT\*

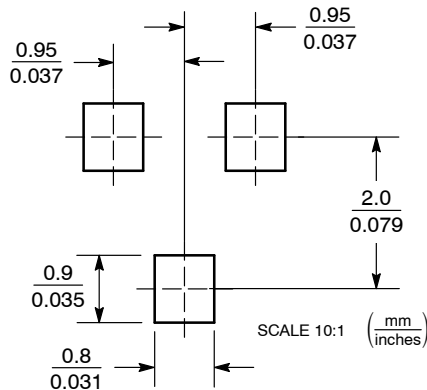

\*For additional information on our Pb-Free strategy and soldering details, please download the ON Semiconductor Soldering and Mounting Techniques Reference Manual, SOLDERRM/D.

ON Semiconductor and are registered trademarks of Semiconductor Components Industries, LLC (SCILLC). SCILLC reserves the right to make changes without further notice to any products herein. SCILLC makes no warranty, representation or guarantee regarding the suitability of its products for any particular purpose, nor does SCILLC assume any liability arising out of the application or use of any product or circuit, and specifically disclaims any and all liability, including without limitation special, consequential or incidental damages. "Typical" parameters which may be provided in SCILLC data sheets and/or specifications can and do vary in different applications and actual performance may vary over time. All operating parameters, including "Typicals" must be validated for each customer application by customer's technical experts. SCILLC does not convey any license under its patent rights nor the rights of others. SCILLC products are not designed, intended, or authorized for use as components in systems intended for surgical implant into the body, or other applications intended to support or sustain life, or for any other application in which the failure of the SCILLC product could create a situation where personal injury or death may occur. Should Buyer purchase or use SCILLC products for any such unintended or unauthorized application, Buyer shall indemnify and hold SCILLC and its officers, employees, subsidiaries, affiliates, and distributors harmless against all claims, costs, damages, and expenses, and reasonable attorney fees arising out of, directly or indirectly, any claim of personal injury or death associated with such unintended or unauthorized use, even if such claim alleges that SCILLC was negligent regarding the design or manufacture of the part. SCILLC is an Equal Opportunity/Affirmative Action Employer. This literature is subject to all applicable copyright laws and is not for resale in any manner.

### PUBLICATION ORDERING INFORMATION

LITERATURE FULFILLMENT:

Literature Distribution Center for ON Semiconductor  
P.O. Box 5163, Denver, Colorado 80217 USA  
Phone: 303-675-2175 or 800-344-3860 Toll Free USA/Canada  
Fax: 303-675-2176 or 800-344-3867 Toll Free USA/Canada  
Email: orderlit@onsemi.com

N. American Technical Support: 800-282-9855 Toll Free  
USA/Canada  
Europe, Middle East and Africa Technical Support:  
Phone: 421 33 790 2910  
Japan Customer Focus Center  
Phone: 81-3-5817-1050

ON Semiconductor Website: [www.onsemi.com](http://www.onsemi.com)

Order Literature: <http://www.onsemi.com/orderlit>

For additional information, please contact your local Sales Representative