

**Tactile Switches, .236 [6] x .236 [6], Low Profile, Surface Mount**

**MATERIAL SPECIFICATIONS:**

Contacts .....Copper Alloy, silver clad plated  
 Case Material .....PPS  
 Stem .....PPS  
 Cover.....Steel, tin-plate  
 Terminals .....Copper alloy, silver plated

**TYPICAL PERFORMANCE CHARACTERISTICS:**

Contact Rating .....50mA @ 12 VDC  
 Initial Contact Resistance .....100 Milliohms max.  
 Insulation Resistance .....100 Megohms min. @ 100 VDC  
 Dielectric Strength .....500 VAC, 1 minute  
 Actuation Force .....See Below.  
 Life Expectancy .....Up to 100,000 Cycles

**ENVIRONMENTAL SPECIFICATIONS:**

Operating Temperature.....-4°F to +185°F (-20°C to +85°C)  
 Storage Temperature.....-22°F to +185°F (-30°C to +85°C)  
 Solder Heat Resistance .....IR Soldering EIA-364-56  
 Procedure 5 Level 2, 464°F (240°C)



FSM1LP

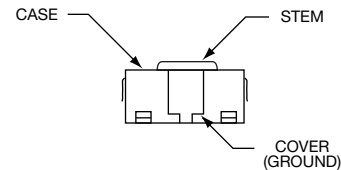
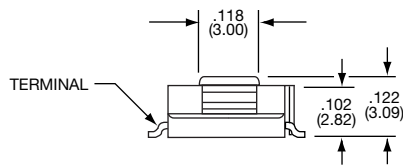
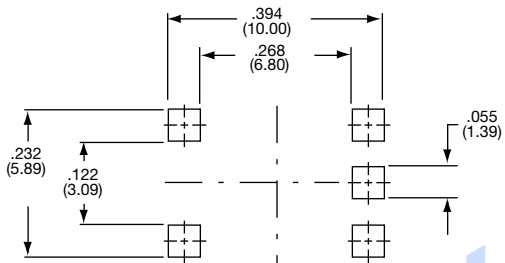
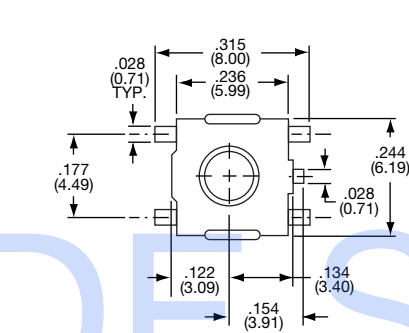

PDF Support

E  
FSM1LP Series

FSM4LP

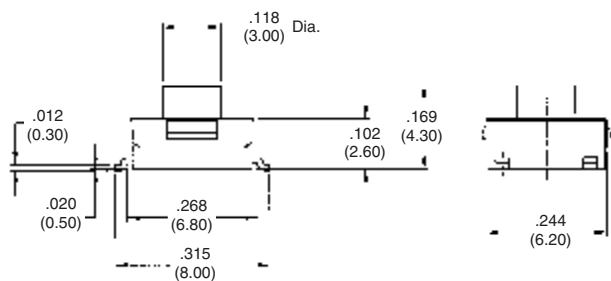
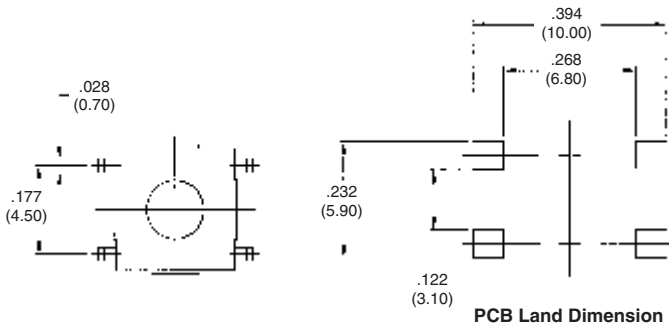

Tyco Electronics	Alcoswitch	Force	Actuator Packaging
1-1437565-6	FSM1LP	160	Bulk
1-1437565-7	FSM1LPA	260	Bulk
1-1437565-9	FSM1LPTR	160	Tape & Reel
1-1437565-8	FSM1LPATR	260	Tape & Reel
1571621-1	FSM4LP	260	Bulk
4-1437565-3	FSM4LPTR	260	Tape & Reel

**Tactile Switches, .472 [12] x .472 [12], Flush or Extended Actuators**

**MATERIAL SPECIFICATIONS:**

Contacts .....Copper alloy, silver clad plate  
 Case.....PBT  
 Actuator Button .....Polyacetal Resin  
 Cover.....PET film  
 Terminals .....Copper alloy, silver plate  
 Frame (R/A) .....Nylon

**TYPICAL PERFORMANCE CHARACTERISTICS:**

Contact Rating .....50 mA @ 12 VDC  
 Initial Contact Resistance .....100 Milliohms max.  
 Insulation Resistance .....100 Megohms min. @100 VDC  
 Dielectric Strength .....500 VAC for 1 minute  
 Actuation Force .....See below  
 Actuator Travel.....0.012"(0.3)  
 Life Expectancy .....Up to 100,000 cycles

**ENVIRONMENTAL SPECIFICATIONS**

Operating Temperature.....4°F to +185°F (-20°C to +85°C)  
 Storage Temperature.....-22°F to +185°F (-30°C to +85°C)  
 Solder Heat Resistance .....See Page M3-4



FSM100

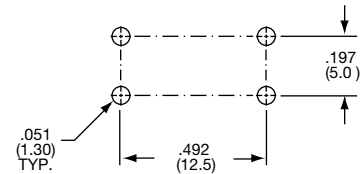
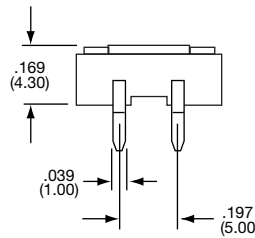
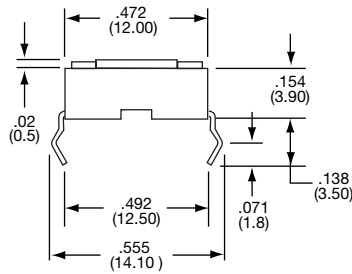
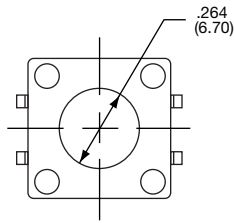

Tyco Electronics	Alcoswitch	Type			Force
1437565-2	FSM100	SPST	Off	(On)	160±50gf
1571139-1	FSM100A	SPST	Off	(On)	260±50gf

(On) indicates momentary position.



FSM101

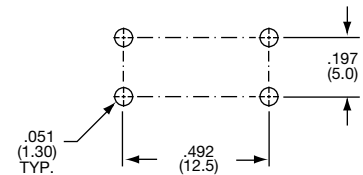
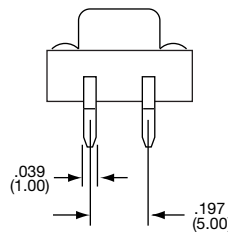
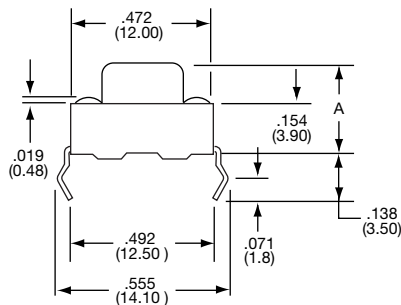
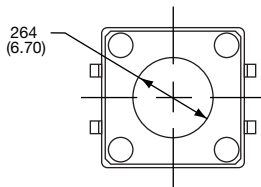

Tyco Electronics	Alcoswitch	Type			Force	Dim A
1437565-3	FSM101	SPST	Off	(On)	160±50gf	.295 [7.5mm]
1571140-1	FSM201A	SPST	Off	(On)	260±50gf	.335 [8.5mm]

(On) indicates momentary position.

E  
FSM100-104 Series

**Tactile Switches, .472 [12] x .472 [12], Vertical or Right Angle**

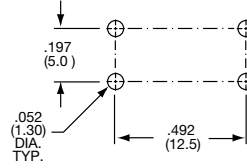
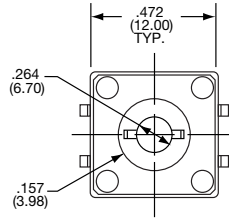
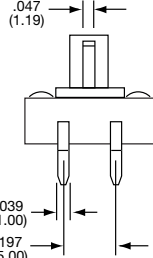
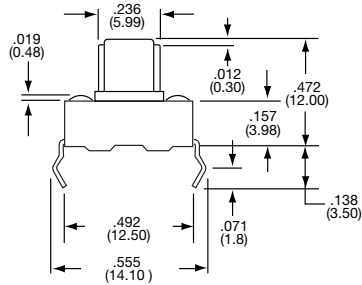

FSM102

Tyco Electronics	Alcoswitch	Type			Force
1437565-4	FSM102	SPST	Off	(On)	160±50gf
1571061-1	FSM102A	SPST	Off	(On)	260±50gf

(On) indicates momentary position.

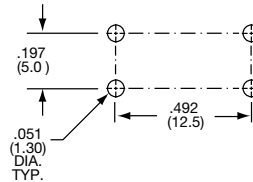
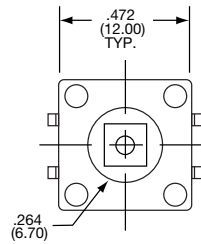
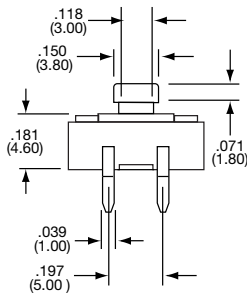
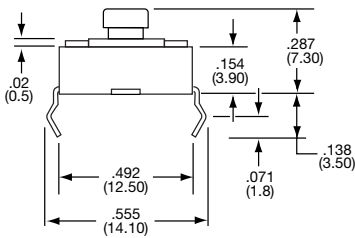

FSM103

Tyco Electronics	Alcoswitch	Type			Force
1437565-5	FSM103	SPST	Off	(On)	160±50gf

(On) indicates momentary position.

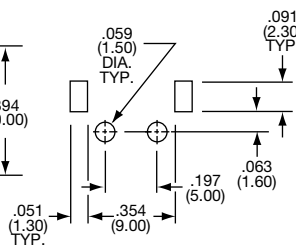
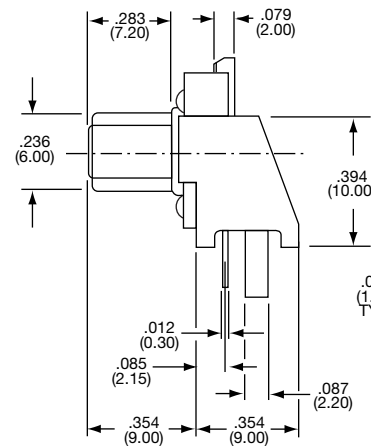
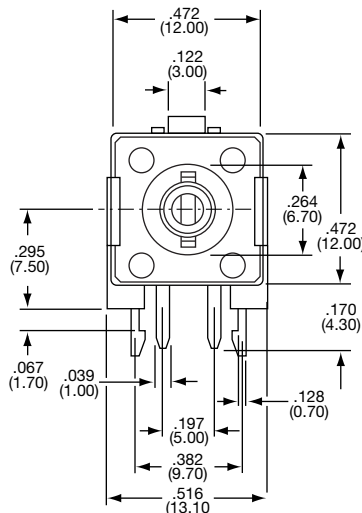

Tyco Electronics	Alcoswitch	Type			Force
1437565-6	FSM104	SPST	Off	(On)	160±50gf

(On) indicates momentary position.

**Tactile Switches, Sealed .472 [12] x .472 [12], Surface Mount, Projected Actuator**

**MATERIAL SPECIFICATIONS:**

Case .....Thermoplastic, UL94V-0, Black  
 Stem/Actuator .....Thermoplastic, UL94V-0, Black  
 Cover .....Stainless Steel  
 Seal .....Silicone Rubber, Black  
 Contact.....Stainless Steel, Plating—Silver  
 Terminal .....Copper Alloy, Plating—Silver/Nickel

**TYPICAL PERFORMANCE CHARACTERISTICS:**

Contact Rating .....50mA @ 12 V DC  
 Initial Contact Resistance .....100MilliOhms Max  
 Insulation Resistance .....100Megaohms @ 100VDC Min.  
 Dielectric Strength .....500 VAC  
 Actuation Travel.....0.014 +/- .008 (.35 +/- .20)  
 Life .....Up to 1,000,000 Cycles

**ENVIRONMENTAL SPECIFICATIONS:**

Operating Temperature .....-4 to +185°F (-20 to +70°C)  
 Storage Temperature .....-4 to +185°F (-20 to +70°C)  
 Resistance to solder heat .....Per EIA-364-56, Procedure 4 & 5, Level 3  
 Solderability .....Per EIA RS-186-9E  
 Seal .....Per IP67

**E**

Sealed Tactile Switches

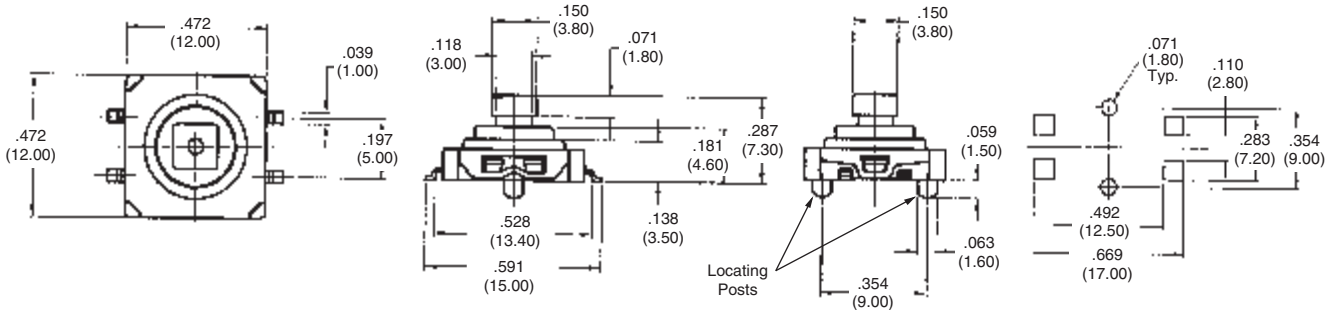

Tyco Electronics	Locating Post	Packaging	Actuator Height	Force
1571217-1	No	Bulk	.287 (7.30)	160±70gf
1571217-2	Yes	Bulk	.287 (7.30)	160±70gf
1571217-3	No	T&R	.287 (7.30)	160±70gf
1571217-4	Yes	T&R	.287 (7.30)	160±70gf

**Tactile Switches, Sealed .472 [12] x .472 [12], Surface Mount, Flush, Actuator**

**MATERIAL SPECIFICATIONS:**

Case .....Thermoplastic, UL94V-0, Black  
 Stem/Actuator .....Thermoplastic, UL94V-0, Black  
 Cover .....Stainless Steel  
 Seal .....Silicone Rubber, Black  
 Contact.....Stainless Steel, Plating—Silver  
 Terminal .....Copper Alloy, Plating—Silver/Nickel

**TYPICAL PERFORMANCE CHARACTERISTICS:**

Contact Rating .....50mA @ 12 V DC  
 Initial Contact Resistance .....100MilliOhms Max  
 Insulation Resistance .....100Megaohms @ 100VDC Min.  
 Dielectric Strength .....500 VAC  
 Actuation Travel.....0.014 +/-0.008 (.35 +/- .20)  
 Life .....Up to 1,000,000 Cycles

**ENVIRONMENTAL SPECIFICATIONS:**

Operating Temperature .....-4 to +185°F (-20 to +85°C)  
 Storage Temperature .....-4 to +185°F (-20 to +85°C)  
 Resistance to solder heat .....Per EIA-364-56, Procedure 4 & 5, Level 3  
 Solderability .....Per EIA RS-186-9E  
 Seal .....Per IP67

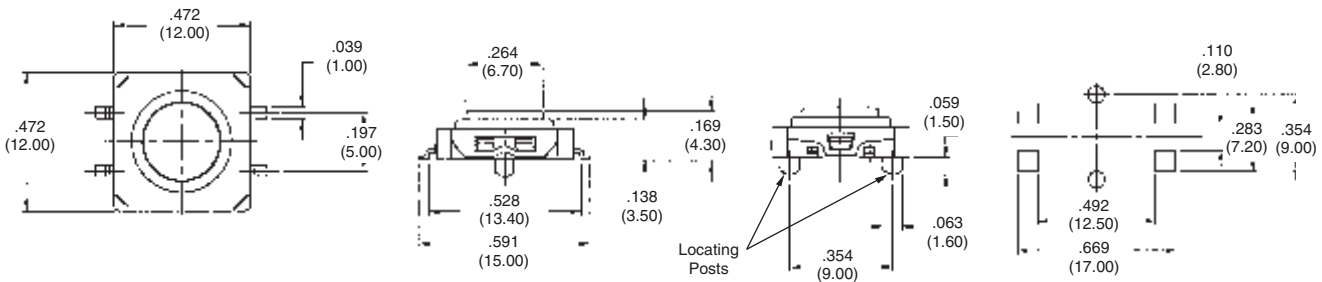

Tyco Electronics	Locating Post	Packaging	Actuator Height	Force
1571218-1	No	Bulk	.169 (4.30)	160±70gf
1571218-2	Yes	Bulk	.169 (4.30)	160±70gf
1571218-3	No	T&R	.169 (4.30)	160±70gf
1571218-4	Yes	T&R	.169 (4.30)	160±70gf

**Tactile Switches, Sealed .472 [12] x .472 [12], Thru-Hole, Projected Actuator**

**MATERIAL SPECIFICATIONS:**

Case .....Thermoplastic, UL94V-0, Black  
 Stem/Actuator .....Thermoplastic, UL94V-0, Black  
 Cover .....Stainless Steel  
 Seal .....Silicone Rubber, Black  
 Contact.....Stainless Steel, Plating—Silver  
 Terminal .....Copper Alloy, Plating—Silver/Nickel

**TYPICAL PERFORMANCE CHARACTERISTICS:**

Contact Rating .....50mA @ 12 V DC  
 Initial Contact Resistance .....100MilliOhms Max  
 Insulation Resistance .....100Megaohms @ 100VDC Min.  
 Dielectric Strength .....500 VAC  
 Actuation Travel.....0.014 +/-0.008 (.35 +/- .20)  
 Life .....1,000,000 Cycles

**ENVIRONMENTAL SPECIFICATIONS:**

Operating Temperature .....-4 to +185°F (-20 to +85°C)  
 Storage Temperature .....-4 to +185°F (-20 to +85°C)  
 Resistance to solder heat .....Per EIA-364-56, Procedure 3, Test Cond. B  
 Solderability .....Per EIA RS-186-9E  
 Seal .....Per IP67

**E**

Sealed Tactile Switches

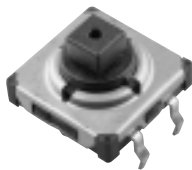
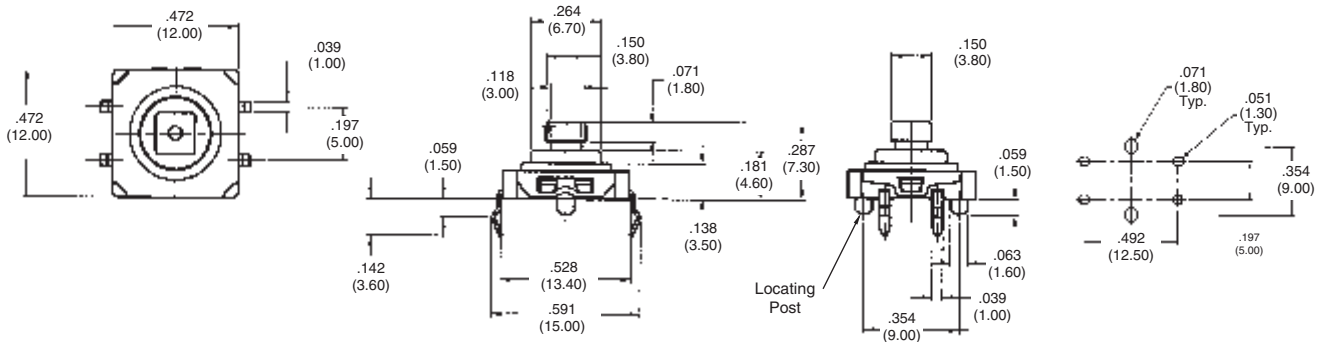

Tyco Electronics	Locating Post	Packaging	Actuator Height	Force
1571219-1	No	Bulk	.287 (7.30)	160±70gf
1571219-2	Yes	Bulk	.287 (7.30)	160±70gf

**Tactile Switches, Sealed .472 [12] x .472 [12], Thru-Hole, Flush Actuator**

**MATERIAL SPECIFICATIONS:**

Case .....Thermoplastic, UL94V-0, Black  
 Stem/Actuator .....Thermoplastic, UL94V-0, Black  
 Cover .....Stainless Steel  
 Seal .....Silicone Rubber, Black  
 Contact.....Stainless Steel, Plating—Silver  
 Terminal .....Copper Alloy, Plating—Silver/Nickel

**TYPICAL PERFORMANCE CHARACTERISTICS:**

Contact Rating .....50mA @ 12 V DC  
 Initial Contact Resistance .....100MilliOhms Max  
 Insulation Resistance .....100Megaohms @ 100VDC Min.  
 Dielectric Strength .....500 VAC  
 Actuation Travel.....0.014 +/-0.008 (.35 +/- .20)  
 Life .....1,000,000 Cycles

**ENVIRONMENTAL SPECIFICATIONS:**

Operating Temperature .....-4 to +185°F (-20 to +85°C)  
 Storage Temperature .....-4 to +185°F (-20 to +85°C)  
 Resistance to solder heat .....Per EIA-364-56, Procedure 3, Test Cond. B  
 Solderability .....Per EIA RS-186-9E  
 Seal .....Per IP67

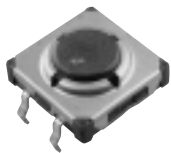
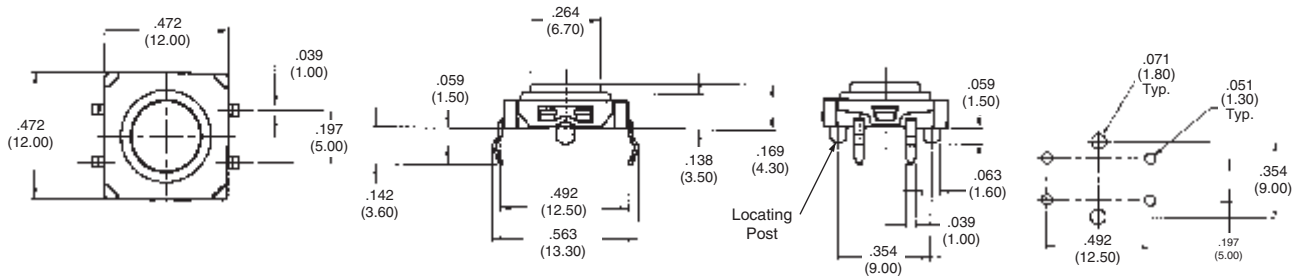

Tyco Electronics	Locating Post	Packaging	Actuator Height	Force
1571220-1	No	Bulk	.169 (4.30)	160±70gf
1571220-2	Yes	Bulk	.169 (4.30)	160±70gf

**E**  
Sealed Tactile Switches

**Tactile Switches, Sealed .299 [7.6] x .287 [7.3], Surface Mount, Extended Actuator**

**MATERIAL SPECIFICATIONS:**

Case .....Thermoplastic, UL94V-0, Black  
 Stem/Actuator .....Thermoplastic, UL94V-0, Black  
 Cover .....Stainless Steel  
 Seal .....Silicone Rubber, Black  
 Contact.....Stainless Steel, Plating—Silver  
 Terminal .....Copper Alloy, Plating—Silver

**TYPICAL PERFORMANCE CHARACTERISTICS:**

Contact Rating .....50mA @ 12 V DC  
 Initial Contact Resistance .....100MilliOhms Max  
 Insulation Resistance .....100Megaohms @ 100VDC Min.  
 Dielectric Strength .....500 VAC  
 Actuation Travel.....0.014 +/- .008 (.35 +/- .20)  
 Life .....Up to 1,000,000 Cycles

**ENVIRONMENTAL SPECIFICATIONS:**

Operating Temperature .....-4 to +185°F (-20 to +85°C)  
 Storage Temperature .....-4 to +185°F (-20 to +85°C)  
 Resistance to solder heat .....Per EIA-364-56, Procedure 4 & 5, Level 3  
 Solderability .....Per EIA RS-186-9E  
 Seal .....Per IP67

E

Sealed Tactile Switches

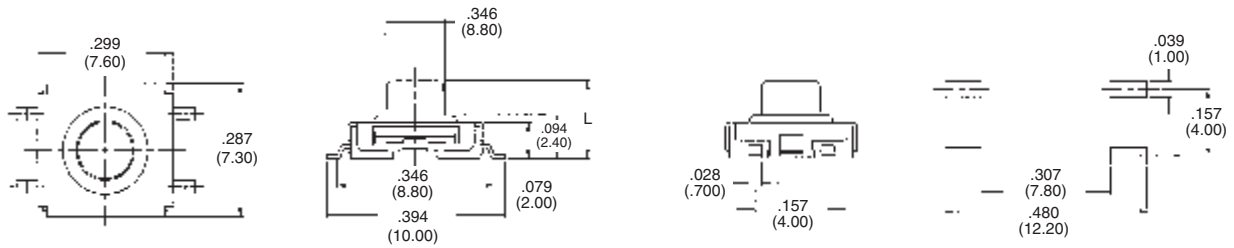

Tyco Electronics	Packaging	L	Force
1571294-1	Bulk	.169 (4.30)	160±50gf
1571294-2	T&R	.169 (4.30)	160±50gf
1571294-3	Bulk	.197 (5.00)	160±50gf
1571294-4	T&R	.197 (5.00)	160±50gf



**Tactile Switches, Sealed .299 [7.6] x .287 [7.3], Surface Mount, Flush Actuator**

**MATERIAL SPECIFICATIONS:**

Case .....Thermoplastic, UL94V-0, Black  
 Stem/Actuator .....Thermoplastic, UL94V-0, Black  
 Cover .....Stainless Steel  
 Seal .....Silicone Rubber, Black  
 Contact.....Stainless Steel, Plating—Silver  
 Terminal .....Copper Alloy, Plating—Silver/Nickel

**TYPICAL PERFORMANCE CHARACTERISTICS:**

Contact Rating .....50mA @ 12 V DC  
 Initial Contact Resistance .....100MilliOhms Max  
 Insulation Resistance .....100Megaohms @ 100VDC Min.  
 Dielectric Strength .....500 VAC  
 Actuation Travel.....0.014 +/- .008 (.35 +/- .20)  
 Life .....Up to 1,000,000 Cycles

**ENVIRONMENTAL SPECIFICATIONS:**

Operating Temperature .....-4 to +185°F (-20 to +85°C)  
 Storage Temperature .....-4 to +185°F (-20 to +85°C)  
 Resistance to solder heat .....Per EIA-364-56, Procedure 4 & 5, Level 3  
 Solderability .....Per EIA RS-186-9E  
 Seal .....Per IP67

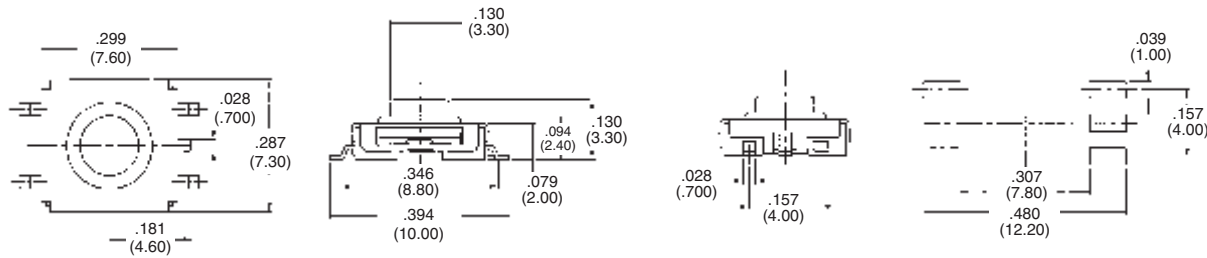

Tyco Electronics	Packaging	Actuator Height	Force
1571296-1	Bulk	.130 (3.30)	160±50gf
1571296-2	T&R	.130 (3.30)	160±50gf

**E**  
Sealed Tactile Switches

**Tactile Switches, Sealed .299 [7.6] x .287 [7.3], Thru-Hole, Extended Actuator**

**MATERIAL SPECIFICATIONS:**

Case .....Thermoplastic, UL94V-0, Black  
 Actuator .....Thermoplastic, UL94V-0, Black  
 Cover .....Stainless Steel  
 Seal .....Silicone Rubber, Black  
 Contact.....Stainless Steel, Plating—Silver  
 Terminal .....Copper Alloy, Plating—Silver/Nickel

**TYPICAL PERFORMANCE CHARACTERISTICS:**

Contact Rating .....50mA @ 12 V DC  
 Initial Contact Resistance .....100MilliOhms Max  
 Insulation Resistance .....100Megaohms @ 100VDC Min.  
 Dielectric Strength .....500 VAC  
 Actuation Travel .....0.014 +/-0.008 (.35 +/- .20)  
 Life .....Up to 1,000,000 Cycles

**ENVIRONMENTAL SPECIFICATIONS:**

Operating Temperature .....-4 to +185°F (-20 to +85°C)  
 Storage Temperature .....-4 to +185°F (-20 to +85°C)  
 Resistance to solder heat .....Per EIA-364-56, Procedure 3, Test Cond.B  
 Solderability .....Per EIA RS-186-9E  
 Seal .....Per IP67

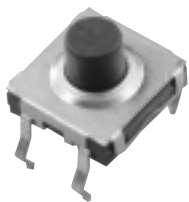
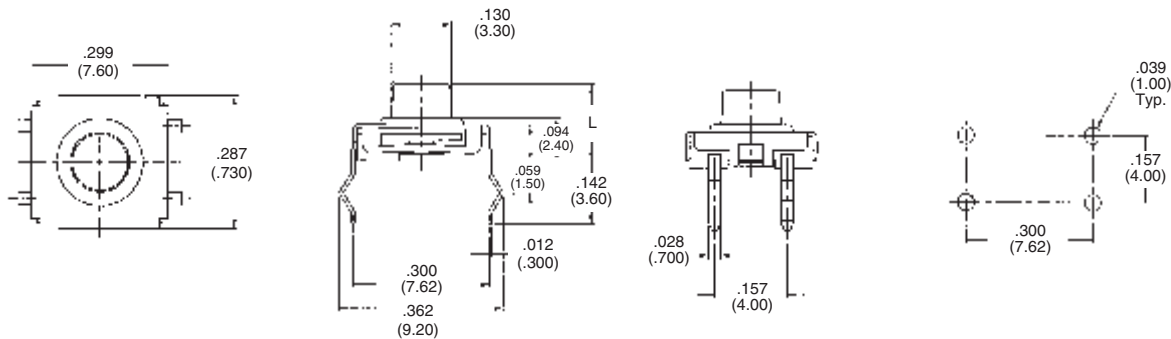

Tyco Electronics	Packaging	L	Force
1571295-1	Bulk	.169 (4.30)	160±50gf
1571295-2	Bulk	.197 (5.00)	160±50gf

**E**

Sealed Tactile Switches

**Tactile Switches, Sealed .185 [4.7] x .268 [6.8], Surface Mount**

**MATERIAL SPECIFICATIONS:**

Case .....Thermoplastic, UL94V-0, Black  
 Stem/Actuator .....Thermoplastic, UL94V-0, Black  
 Cover .....Stainless Steel  
 Seal .....Silicone Rubber, Black  
 Contact.....Stainless Steel, Plating—Silver  
 Terminal .....Copper Alloy, Plating—Silver/Nickel

**TYPICAL PERFORMANCE CHARACTERISTICS:**

Contact Rating .....50mA @ 12 V DC  
 Initial Contact Resistance .....100MilliOhms Max  
 Insulation Resistance .....100Megaohms @ 100VDC Min.  
 Dielectric Strength .....500 VAC  
 Actuation Travel.....0.014 +/-0.008 (.35 +/- .20)  
 Life .....Up to 50,000 Cycles

**ENVIRONMENTAL SPECIFICATIONS:**

Operating Temperature .....-4 to +185°F (-20 to +85°C)  
 Storage Temperature .....-4 to +185°F (-20 to +85°C)  
 Resistance to solder heat .....Per EIA-364-56, Procedure 4 & 5, Level 3  
 Solderability .....Per EIA RS-186-9E  
 Seal .....Per IP67

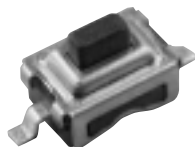
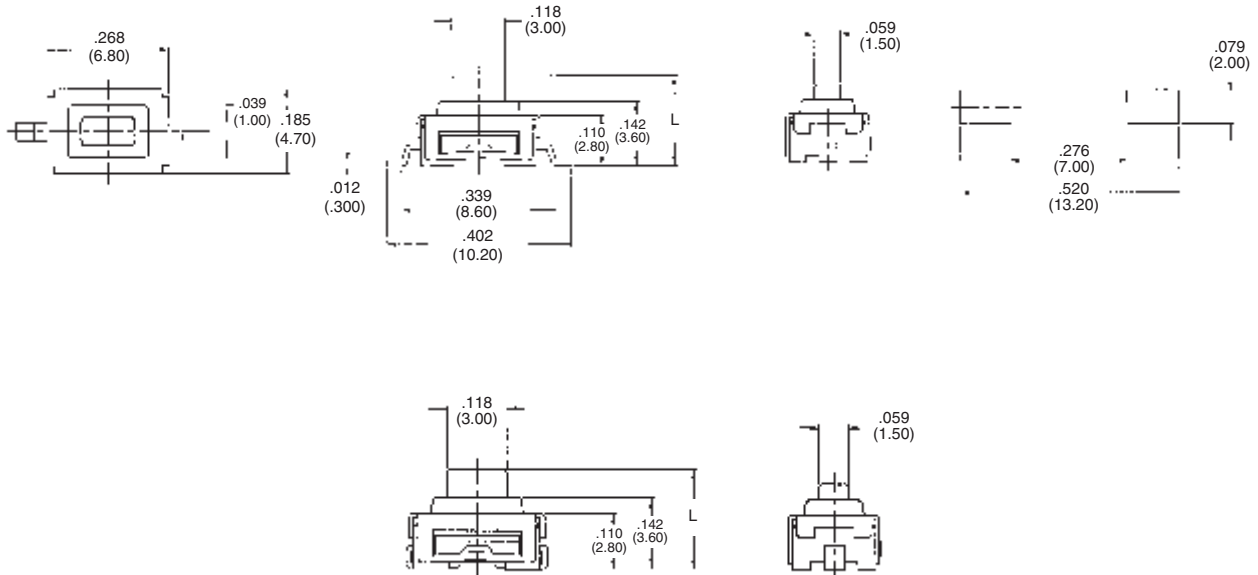

Tyco Electronics	Packaging	L	Operating Force	Lead Style
1571298-1	Bulk	.197 (5.00)	130 ± 50gf	Gull Wing
1571298-2	T&R	.197 (5.00)	130 ± 50gf	Gull Wing
1571299-1	Bulk	.169 (4.30)	130 ± 50gf	J Lead
1571299-2	T&R	.169 (4.30)	130 ± 50gf	J Lead
1571299-3	Bulk	.197 (5.00)	130 ± 50gf	J Lead
1571299-4	T&R	.197 (5.00)	130 ± 50gf	J Lead

**E**  
Sealed Tactile Switches