

GaAlAs-IR-Lumineszenzdiode (880 nm)
GaAlAs Infrared Emitter (880 nm)
Lead (Pb) Free Product - RoHS Compliant

SFH 487



Wesentliche Merkmale

- GaAlAs-LED mit sehr hohem Wirkungsgrad
- Hohe Zuverlässigkeit
- UL Version erhältlich
- Hohe Impulsbelastbarkeit
- Gute spektrale Anpassung an Si-Fotoempfänger
- Gehäusegleich mit SFH 309, SFH 409

Features

- Very highly efficient GaAlAs-LED
- High reliability
- UL version available
- High pulse handling capability
- Good spectral match to silicon photodetectors
- Same package as SFH 309, SFH 409

Anwendungen

- IR-Fernsteuerung von Fernseh-, Rundfunk- und Videogeräten, Lichtdimmern
- Lichtschranken bis 500 kHz
- Münzzähler
- Rauchmelder
- Sensorik
- Diskrete Optokoppler

Applications

- IR remote control for hifi and TV sets, video tape recorder, dimmers
- Light-reflection switches (max. 500 kHz)
- Coin counters
- Smoke detectors
- Sensor technology
- Discrete optocouplers

Typ Type	Bestellnummer Ordering Code	Strahlstärkegruppierung ¹⁾ ($I_F = 100 \text{ mA}$, $t_p = 20 \text{ ms}$) Radiant intensity grouping ¹⁾ , I_e (mW/sr)
SFH 487	Q62703Q1095	> 12.5
SFH 487-2	Q62703Q2174	20 ... 80
SFH 487-3	Q62703Q2175	31 ... 125

¹⁾ gemessen bei einem Raumwinkel $\Omega = 0.01 \text{ sr}$ / measured at a solid angle of $\Omega = 0.01 \text{ sr}$

Grenzwerte ($T_A = 25\text{ °C}$)**Maximum Ratings**

Bezeichnung Parameter	Symbol Symbol	Wert Value	Einheit Unit
Betriebs- und Lagertemperatur Operating and storage temperature range	$T_{op}; T_{stg}$	- 40 ... + 100	°C
Sperrspannung Reverse voltage	V_R	5	V
Durchlaßstrom Forward current	I_F	100	mA
Stoßstrom, $\tau \leq 10\ \mu\text{s}$ Surge current	I_{FSM}	2.5	A
Verlustleistung Power dissipation	P_{tot}	200	mW
Wärmewiderstand, freie Beinchenlänge max. 10 mm Thermal resistance, lead length between package bottom and PC-board max. 10 mm	R_{thJA}	375	K/W

Kennwerte ($T_A = 25\text{ °C}$)**Characteristics**

Bezeichnung Parameter	Symbol Symbol	Wert Value	Einheit Unit
Wellenlänge der Strahlung Wavelength at peak emission $I_F = 100\text{ mA}$	λ_{peak}	880	nm
Spektrale Bandbreite bei 50% von I_{max} , $I_F = 100\text{ mA}$ Spectral bandwidth at 50% of I_{max}	$\Delta\lambda$	80	nm
Abstrahlwinkel Half angle	φ	± 20	Grad deg.
Aktive Chipfläche Active chip area	A	0.09	mm ²
Abmessungen der aktiven Chipfläche Dimension of the active chip area	$L \times B$ $L \times W$	0.3×0.3	mm ²
Abstand Chipoberfläche bis Linsenscheitel Distance chip front to lens top	H	2.6	mm

Kennwerte ($T_A = 25\text{ °C}$)

Characteristics (cont'd)

Bezeichnung Parameter	Symbol Symbol	Wert Value	Einheit Unit
Schaltzeiten, I_e von 10% auf 90% und von 90% auf 10%, bei $I_F = 100\text{ mA}$, $R_L = 50\ \Omega$ Switching times, I_e from 10% to 90% and from 90% to 10%, $I_F = 100\text{ mA}$, $R_L = 50\ \Omega$	t_r, t_f	0.6/0.5	μs
Kapazität Capacitance $V_R = 0\text{ V}$, $f = 1\text{ MHz}$	C_o	15	pF
Durchlaßspannung Forward voltage $I_F = 100\text{ mA}$, $t_p = 20\text{ ms}$ $I_F = 1\text{ A}$, $t_p = 100\ \mu\text{s}$	V_F	1.5 (< 1.8) 3.0 (< 3.8)	V
Sperrstrom Reverse current $V_R = 5\text{ V}$	I_R	0.01 (≤ 1)	μA
Gesamtstrahlungsfluß Total radiant flux $I_F = 100\text{ mA}$, $t_p = 20\text{ ms}$	Φ_e	25	mW
Temperaturkoeffizient von I_e bzw. Φ_e , $I_F = 100\text{ mA}$ Temperature coefficient of I_e or Φ_e , $I_F = 100\text{ mA}$	TC_I	- 0.5	%/K
Temperaturkoeffizient von V_F , $I_F = 100\text{ mA}$ Temperature coefficient of V_F , $I_F = 100\text{ mA}$	TC_V	- 2	mV/K
Temperaturkoeffizient von λ_{peak} , $I_F = 100\text{ mA}$ Temperature coefficient of λ_{peak} , $I_F = 100\text{ mA}$	TC_λ	0.25	nm/K

Gruppierung der Strahlstärke I_e in Achsrichtunggemessen bei einem Raumwinkel $\Omega = 0.01$ sr**Grouping of Radiant Intensity I_e in Axial Direction**at a solid angle of $\Omega = 0.01$ sr

Bezeichnung Parameter	Symbol	Wert Value			Einheit Unit
		SFH 487-1	SFH 487-2	SFH 487-3	
Strahlstärke Radiant intensity $I_F = 100$ mA, $t_p = 20$ ms	I_e	12.5 ... 25	20 ... 80	31 ... 125	mW/sr
Strahlstärke Radiant intensity $I_F = 1$ A, $t_p = 100$ μ s	$I_{e \text{ typ.}}$	–	270	–	mW/sr

Relative Spectral Emission

$I_{rel} = f(\lambda)$

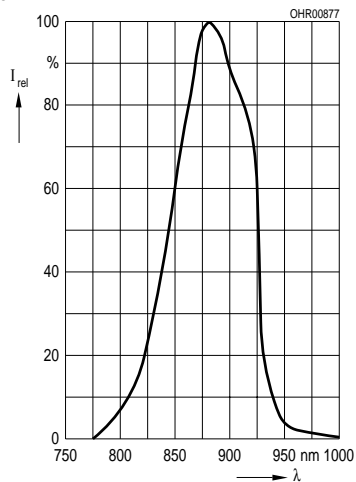

Radiant Intensity $\frac{I_e}{I_e 100 \text{ mA}} = f(I_F)$

Single pulse, $t_p = 20 \mu\text{s}$

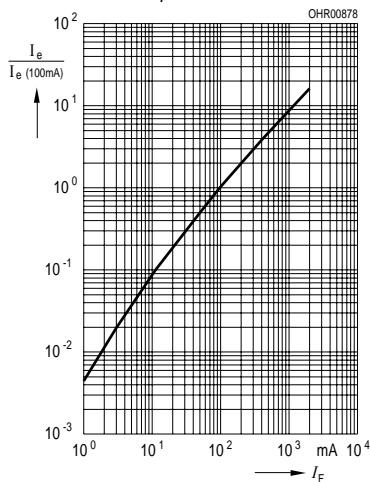

Max. Permissible Forward Current

$I_F = f(T_A)$

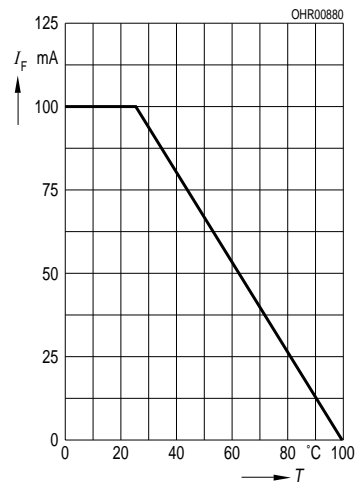

Forward Current, $I_F = f(V_F)$

Single pulse, $t_p = 20 \mu\text{s}$

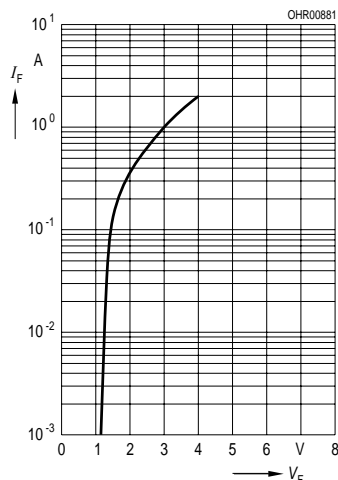

Permissible Pulse Handling Capability $I_F = f(\tau, T_A = 25 \text{ }^\circ\text{C}, \text{duty cycle } D = \text{parameter})$

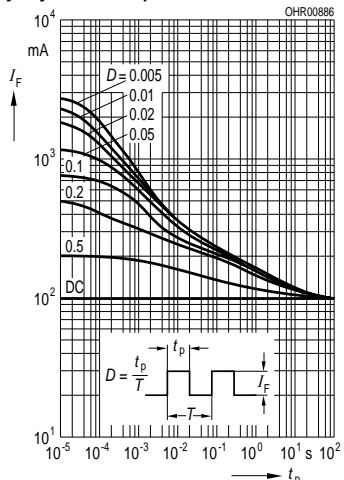

Forward Current vs. Lead Length between the Package Bottom and the PC-Board $I_F = f(l, T_A = 25 \text{ }^\circ\text{C})$

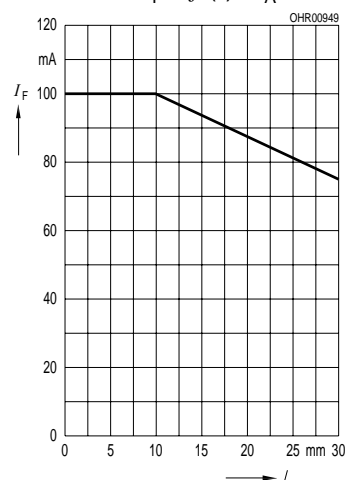

Radiation Characteristics $I_{rel} = f(\varphi)$

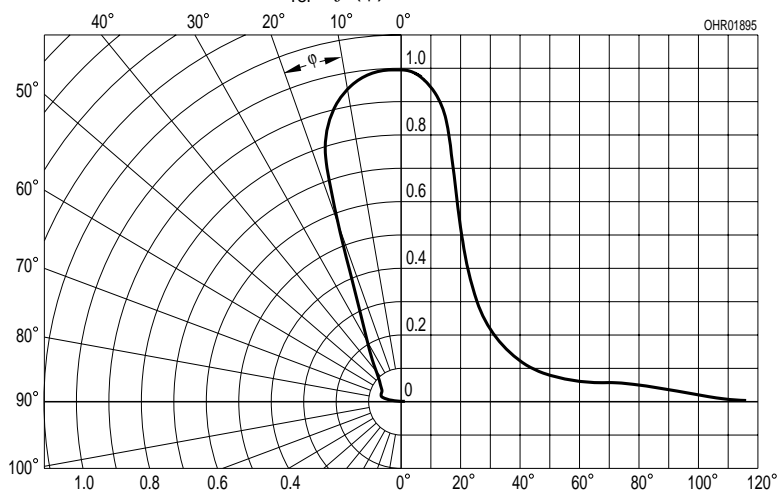

**Maßzeichnung
Package Outlines**

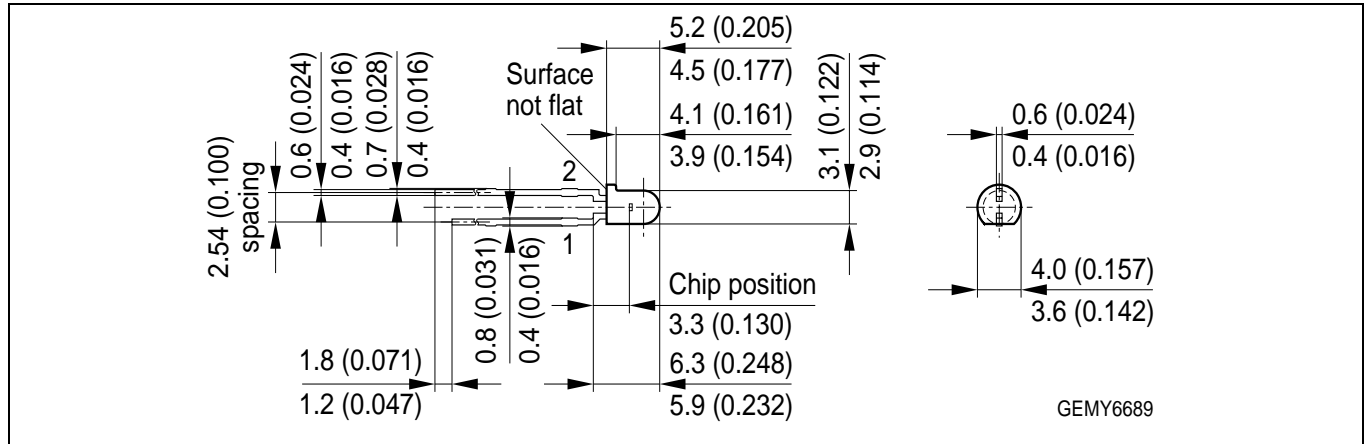

Maße in mm (inch) / Dimensions in mm (inch).

Gehäuse / Package	3mm, klares violettes Gehäuse 1/10 " violett colored transparent package
Anschlußbelegung pin configuration	1 = Anode / anode 2 = Kathode / cathode

**Empfohlenes Lötpaddesign
Recommended Solder Pad**

Wellenlöten (TTW)
TTW Soldering

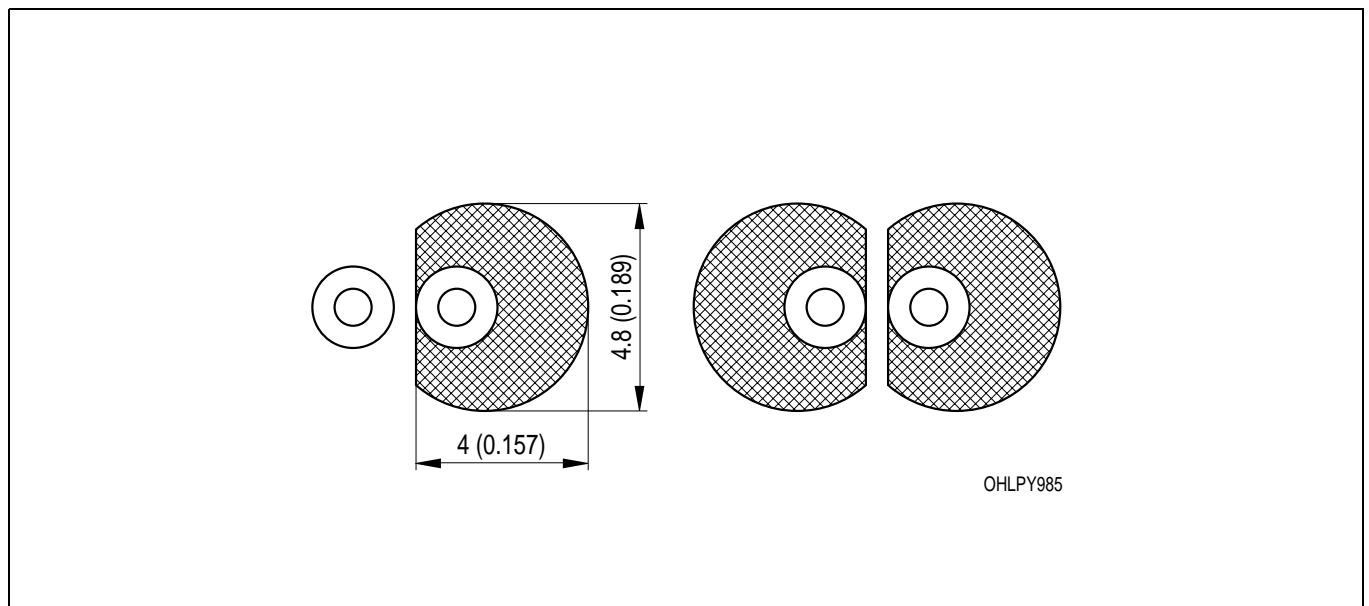

Maße in mm (inch) / Dimensions in mm (inch).

Lötbedingungen
Soldering Conditions
Wellenlöten (TTW)
TTW Soldering

(nach CECC 00802)
(acc. to CECC 00802)

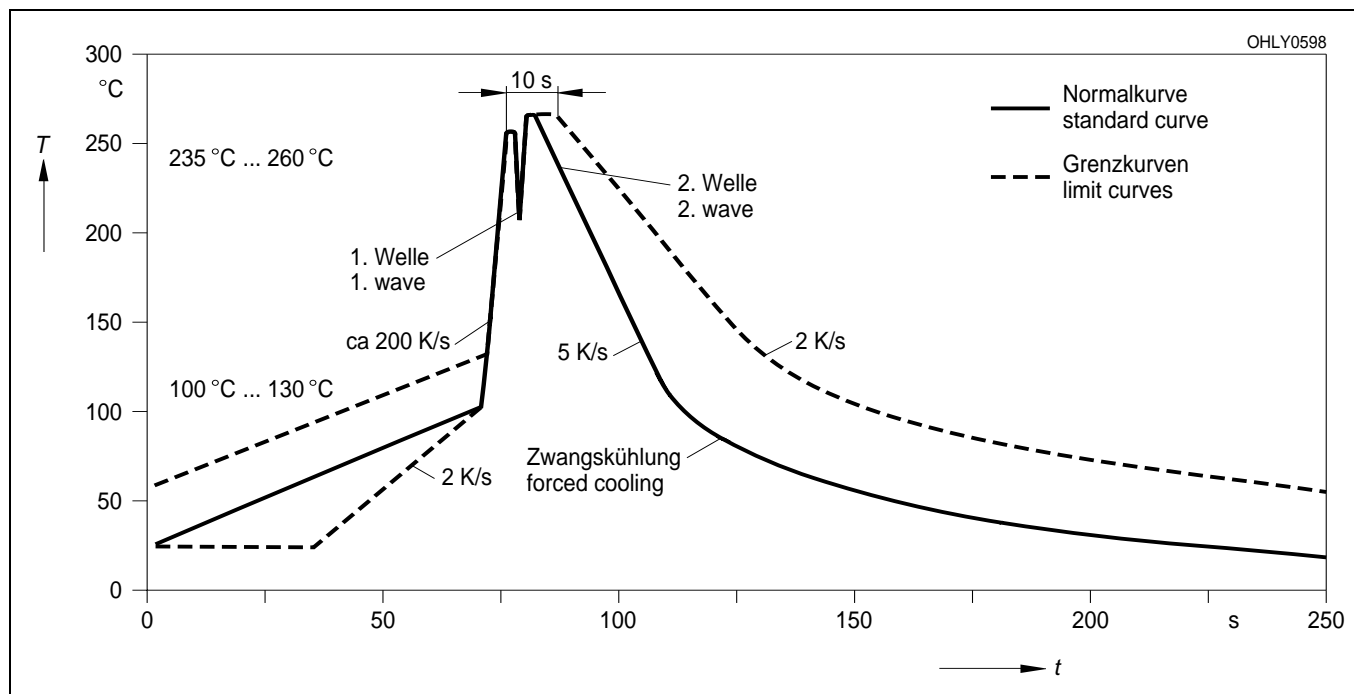

Published by
OSRAM Opto Semiconductors GmbH
Leibnizstrasse 4, D-93055 Regensburg
www.osram-os.com
© All Rights Reserved.

The information describes the type of component and shall not be considered as assured characteristics. Terms of delivery and rights to change design reserved. Due to technical requirements components may contain dangerous substances. For information on the types in question please contact our Sales Organization.

Packing

Please use the recycling operators known to you. We can also help you – get in touch with your nearest sales office. By agreement we will take packing material back, if it is sorted. You must bear the costs of transport. For packing material that is returned to us unsorted or which we are not obliged to accept, we shall have to invoice you for any costs incurred.

Components used in life-support devices or systems must be expressly authorized for such purpose! Critical components¹, may only be used in life-support devices or systems² with the express written approval of OSRAM OS.

¹ A critical component is a component used in a life-support device or system whose failure can reasonably be expected to cause the failure of that life-support device or system, or to affect its safety or effectiveness of that device or system.

² Life support devices or systems are intended (a) to be implanted in the human body, or (b) to support and/or maintain and sustain human life. If they fail, it is reasonable to assume that the health of the user may be endangered.

EU RoHS and China RoHS compliant product



此产品符合欧盟 RoHS 指令的要求；

按照中国的相关法规和标准，不含有毒有害物质或元素。