

Features

- Diffused Junction
- Low Forward Voltage Drop
- High Current Capability
- High Reliability
- High Surge Current Capability
- Green Products in Compliance with the RoHS Directive

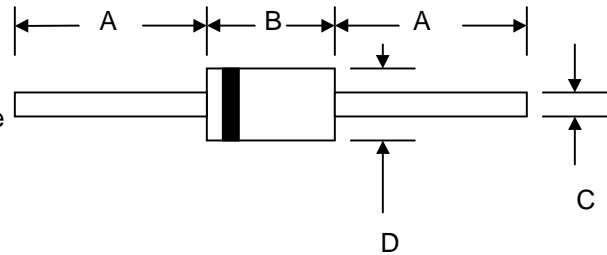

Mechanical Data

- Case: Molded Plastic
- Terminals: Plated Leads Solderable per MIL-STD-202, Method 208
- Polarity: Cathode Band
- Weight: 0.34 grams (approx.)
- Mounting Position: Any
- Marking: Type Number

DO-41				
Dim	Min	Max	Min	Max
A	25.4	—	1.000	—
B	4.06	5.21	0.159	0.205
C	0.71	0.864	0.028	0.034
D	2.00	2.72	0.079	0.107
	In mm		In inch	

Maximum Ratings and Electrical Characteristics @T_A=25°C unless otherwise specified

Single Phase, half wave, 60Hz, resistive or inductive load.
For capacitive load, derate current by 20%.

Characteristic	Symbol	UF 4001-G	UF 4002-G	UF 4003-G	UF 4004-G	UF 4005-G	UF 4006-G	UF 4007-G	Unit
Peak Repetitive Reverse Voltage	V _{RRM}								V
Working Peak Reverse Voltage	V _{RWM}	50	100	200	400	600	800	1000	
DC Blocking Voltage	V _R								
RMS Reverse Voltage	V _{R(RMS)}	35	70	140	280	420	560	700	V
Average Rectified Output Current (Note 1) @T _A = 55°C	I _O	1.0							A
Non-Repetitive Peak Forward Surge Current 8.3ms Single half sine-wave superimposed on rated load (JEDEC Method)	I _{FSM}	30							A
Max. Forward Voltage @I _F = 1.0A	V _{FM}	1.0		1.3		1.7		V	
Peak Reverse Current @T _A = 25°C At Rated DC Blocking Voltage @T _A = 100°C	I _{RM}	5.0 100							μA
Reverse Recovery Time (Note 2)	t _{rr}	50				75			nS
Typical Junction Capacitance (Note 3)	C _j	20				10			pF
Typical Thermal Resistance, Junction to Ambient	R _{θJA}	60							°C/W
Typical Thermal Resistance, Junction to Lead at L= 0.375" (9.53mm)	R _{θJL}	15							°C/W
Operating Temperature Range	T _j	-55 to +125							°C
Storage Temperature Range	T _{STG}	-55 to +150							°C

*Glass passivated forms are available upon request

- Note: 1. Leads maintained at ambient temperature at a distance of 9.5mm from the case
2. Measured with I_F = 0.5A, I_R = 1.0A, I_{RR} = 0.25A. See figure 1.
3. Measured at 1.0 MHz and applied reverse voltage of 4.0V D.C.

Data Sheet 4806, Rev. -

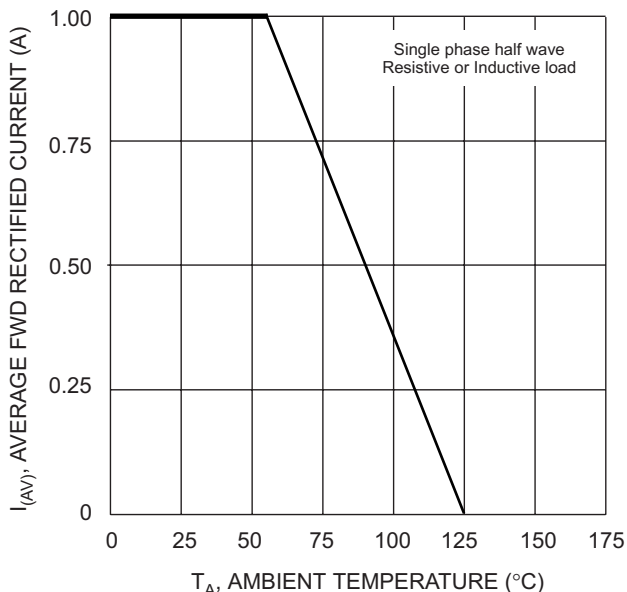

Fig. 1 Forward Current Derating Curve

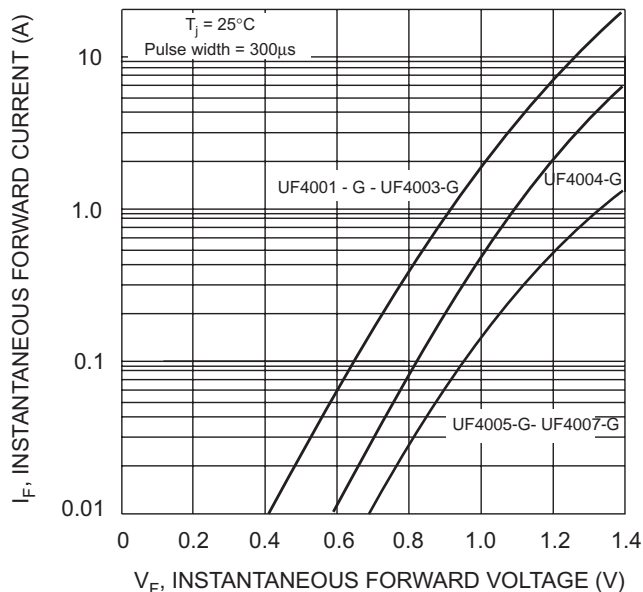

Fig. 2 Typical Forward Characteristics

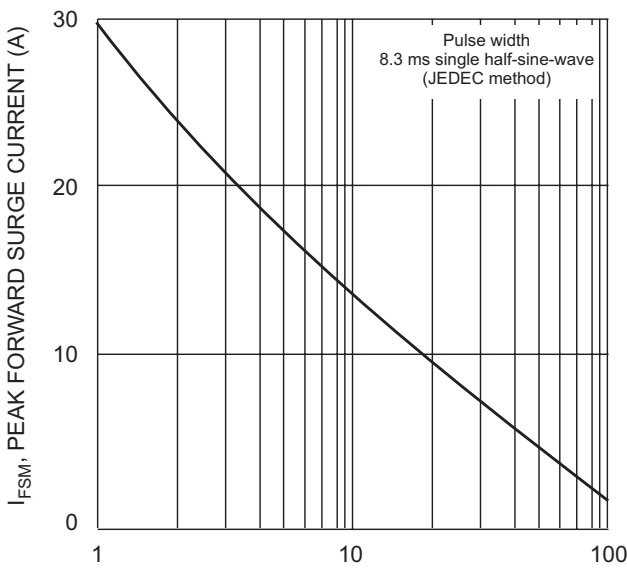

Fig. 3 Peak Forward Surge Current

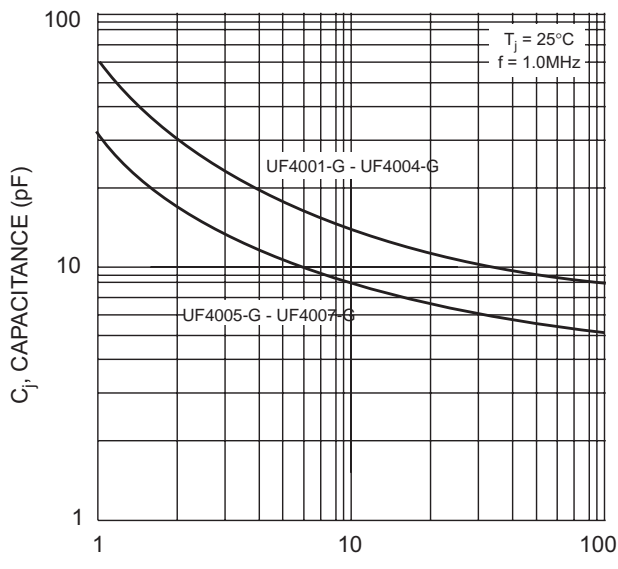
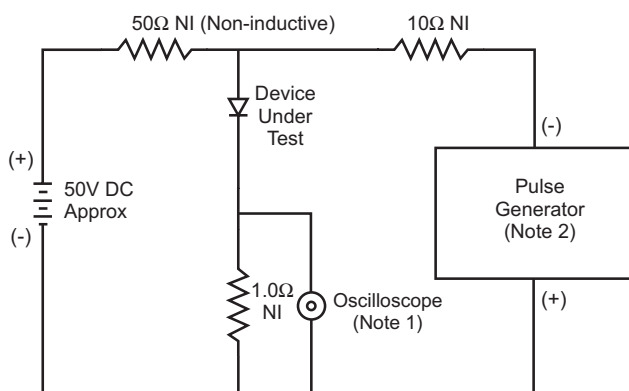
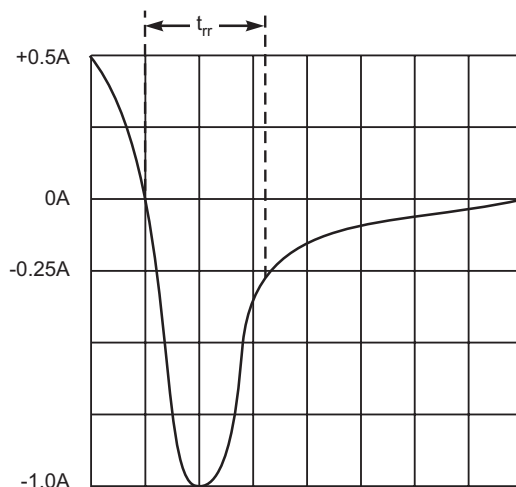

Fig. 4 Typical Junction Capacitance



- Notes:
1. Rise Time = 7.0ns max. Input Impedance = 1.0MΩ, 22pF.
 2. Rise Time = 10ns max. Input Impedance = 50Ω.



Set time base for 5/10ns/cm

Fig. 5 Reverse Recovery Time Characteristic and Test Circuit

DISCLAIMER:

- 1- The information given herein, including the specifications and dimensions, is subject to change without prior notice to improve product characteristics. Before ordering, purchasers are advised to contact the Sensitron Semiconductor sales department for the latest version of the datasheet(s).
- 2- In cases where extremely high reliability is required (such as use in nuclear power control, aerospace and aviation, traffic equipment, medical equipment, and safety equipment), safety should be ensured by using semiconductor devices that feature assured safety or by means of users' fail-safe precautions or other arrangement.
- 3- In no event shall Sensitron Semiconductor be liable for any damages that may result from an accident or any other cause during operation of the user's units according to the datasheet(s). Sensitron Semiconductor assumes no responsibility for any intellectual property claims or any other problems that may result from applications of information, products or circuits described in the datasheets.
- 4- In no event shall Sensitron Semiconductor be liable for any failure in a semiconductor device or any secondary damage resulting from use at a value exceeding the absolute maximum rating.
- 5- No license is granted by the datasheet(s) under any patents or other rights of any third party or Sensitron Semiconductor.
- 6- The datasheet(s) may not be reproduced or duplicated, in any form, in whole or part, without the expressed written permission of Sensitron Semiconductor.
- 7- The products (technologies) described in the datasheet(s) are not to be provided to any party whose purpose in their application will hinder maintenance of international peace and safety nor are they to be applied to that purpose by their direct purchasers or any third party. When exporting these products (technologies), the necessary procedures are to be taken in accordance with related laws and regulations.