

Medium-Power Plastic NPN Silicon Transistors

... designed for driver circuits, switching, and amplifier applications. These high-performance plastic devices feature:

- Low Saturation Voltage — $V_{CE(sat)} = 0.6 \text{ Vdc (Max) @ } I_C = 1.0 \text{ Amp}$
- Excellent Power Dissipation Due to Thermopad Construction — $P_D = 30 \text{ W @ } T_C = 25^\circ\text{C}$
- Excellent Safe Operating Area
- Gain Specified to $I_C = 1.0 \text{ Amp}$
- Complement to PNP 2N4918, 2N4919, 2N4920

***MAXIMUM RATINGS**

Rating	Symbol	2N4921	2N4922	2N4923	Unit
Collector-Emitter Voltage	V_{CEO}	40	60	80	Vdc
Collector-Base Voltage	V_{CB}	40	60	80	Vdc
Emitter-Base Voltage	V_{EB}	5.0			Vdc
Collector Current — Continuous (1)	I_C	1.0 3.0			Adc
Base Current — Continuous	I_B	1.0			Adc
Total Power Dissipation @ $T_C = 25^\circ\text{C}$ Derate above 25°C	P_D	30 0.24			Watts W/ $^\circ\text{C}$
Operating & Storage Junction Temperature Range	T_J, T_{stg}	-65 to +150			$^\circ\text{C}$

**2N4921
thru
2N4923***

*Motorola Preferred Device

**1 AMPERE
GENERAL-PURPOSE
POWER TRANSISTORS
40-80 VOLTS
30 WATTS**

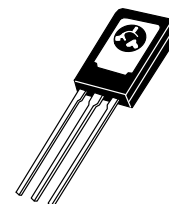

**CASE 77-08
TO-225AA TYPE**

THERMAL CHARACTERISTICS (2)

Characteristic	Symbol	Max	Unit
Thermal Resistance, Junction to Case	θ_{JC}	4.16	$^\circ\text{C/W}$

- (1) The 1.0 Amp maximum I_C value is based upon JEDEC current gain requirements. The 3.0 Amp maximum value is based upon actual current handling capability of the device (see Figures 5 and 6)
- (2) Recommend use of thermal compound for lowest thermal resistance.

* Indicates JEDEC Registered Data.

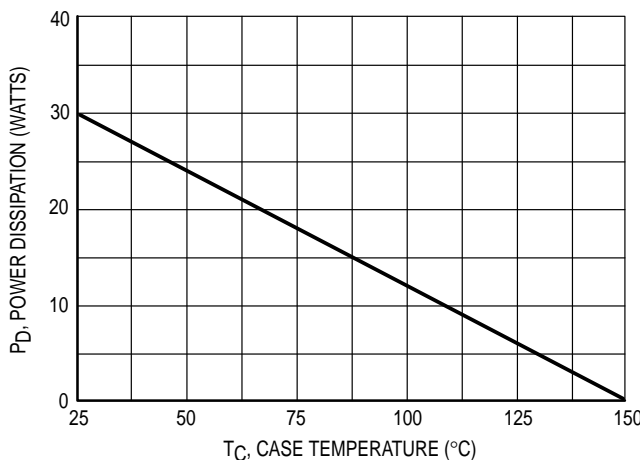

Figure 1. Power Derating

Safe Area Curves are indicated by Figure 5. All limits are applicable and must be observed.

Preferred devices are Motorola recommended choices for future use and best overall value.

REV 7

2N4921 thru 2N4923

ELECTRICAL CHARACTERISTICS (T_C = 25°C unless otherwise noted)

Characteristic	Symbol	Min	Max	Unit
OFF CHARACTERISTICS				
Collector–Emitter Sustaining Voltage (1) (I _C = 0.1 Adc, I _B = 0)	V _{CEO(sus)}	40 60 80	—	Vdc
Collector Cutoff Current (V _{CE} = 20 Vdc, I _B = 0) (V _{CE} = 30 Vdc, I _B = 0) (V _{CE} = 40 Vdc, I _B = 0)	I _{CEO}	— — —	0.5 0.5 0.5	mAdc
Collector Cutoff Current (V _{CE} = Rated V _{CEO} , V _{EB(off)} = 1.5 Vdc) (V _{CE} = Rated V _{CEO} , V _{EB(off)} = 1.5 Vdc, T _C = 125°C)	I _{CEX}	— —	0.1 0.5	mAdc
Collector Cutoff Current (V _{CB} = Rated V _{CB} , I _E = 0)	I _{CBO}	—	0.1	mAdc
Emitter Cutoff Current (V _{EB} = 5.0 Vdc, I _C = 0)	I _{EBO}	—	1.0	mAdc

ON CHARACTERISTICS

DC Current Gain (1) (I _C = 50 mAdc, V _{CE} = 1.0 Vdc) (I _C = 500 mAdc, V _{CE} = 1.0 Vdc) (I _C = 1.0 Adc, V _{CE} = 1.0 Vdc)	h _{FE}	40 30 10	— 150 —	—
Collector–Emitter Saturation Voltage (1) (I _C = 1.0 Adc, I _B = 0.1 Adc)	V _{CE(sat)}	—	0.6	Vdc
Base–Emitter Saturation Voltage (1) (I _C = 1.0 Adc, I _B = 0.1 Adc)	V _{BE(sat)}	—	1.3	Vdc
Base–Emitter On Voltage (1) (I _C = 1.0 Adc, V _{CE} = 1.0 Vdc)	V _{BE(on)}	—	1.3	Vdc

SMALL-SIGNAL CHARACTERISTICS

Current–Gain — Bandwidth Product (I _C = 250 mAdc, V _{CE} = 10 Vdc, f = 1.0 MHz)	f _T	3.0	—	MHz
Output Capacitance (V _{CB} = 10 Vdc, I _E = 0, f = 100 kHz)	C _{ob}	—	100	pF
Small–Signal Current Gain (I _C = 250 mAdc, V _{CE} = 10 Vdc, f = 1.0 kHz)	h _{fe}	25	—	—

(1) Pulse Test: PW ≈ 300 μs, Duty Cycle ≈ 2.0%.

* Indicates JEDEC Registered Data.

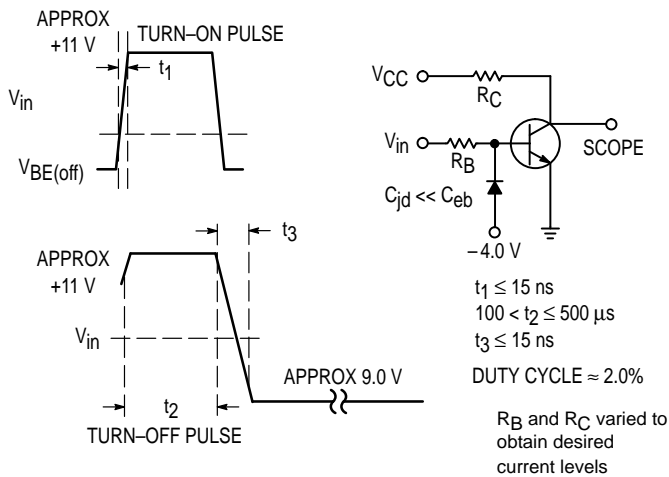

Figure 2. Switching Time Equivalent Circuit

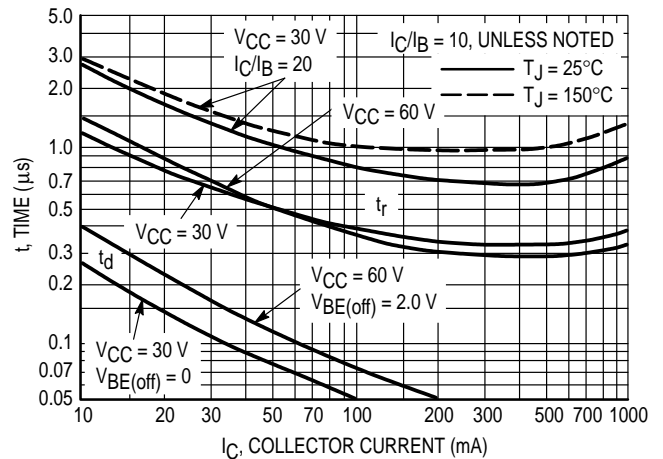

Figure 3. Turn-On Time

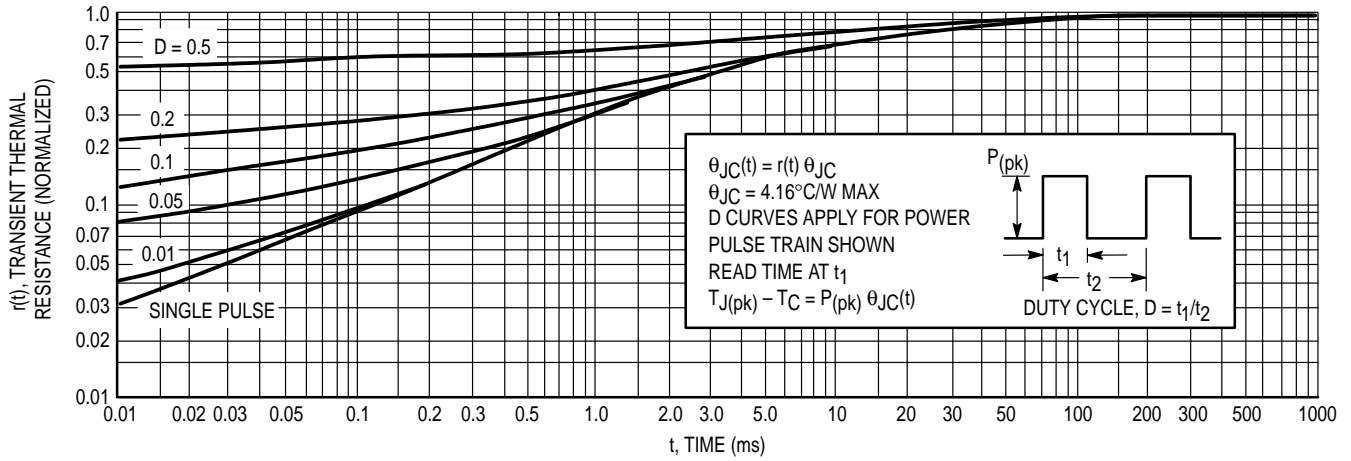

Figure 4. Thermal Response

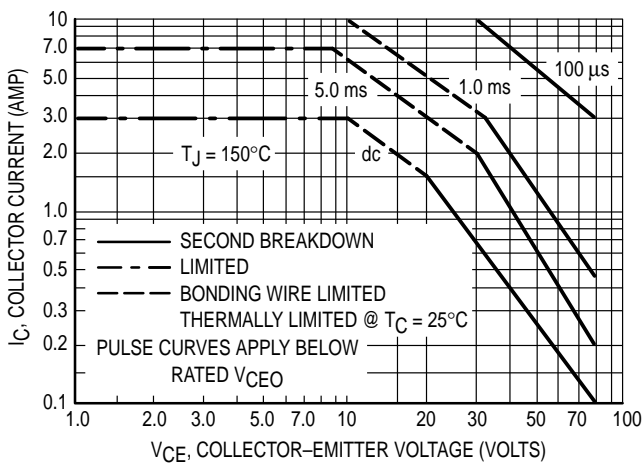

Figure 5. Active-Region Safe Operating Area

There are two limitations on the power handling ability of a transistor: average junction temperature and second breakdown. Safe operating area curves indicate $I_C - V_{CE}$ operation i.e., the transistor must not be subjected to greater dissipation than the curves indicate.

The data of Figure 5 is based on $T_{J(pk)} = 150^{\circ}\text{C}$; T_C is variable depending on conditions. Second breakdown pulse limits are valid for duty cycles to 10% provided $T_{J(pk)} \leq 150^{\circ}\text{C}$. At high case temperatures, thermal limitations will reduce the power that can be handled to values less than the limitations imposed by second breakdown.

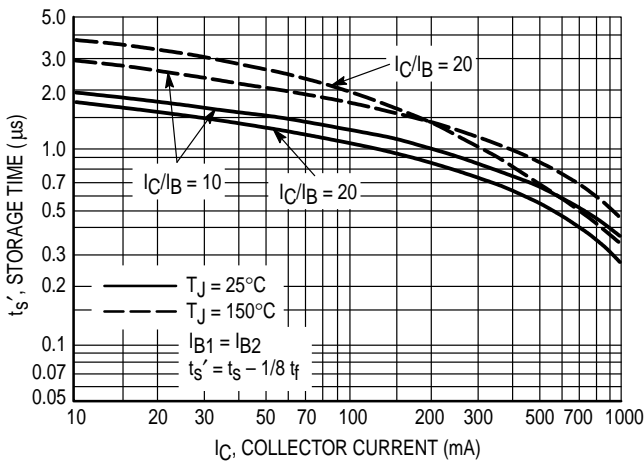

Figure 6. Storage Time

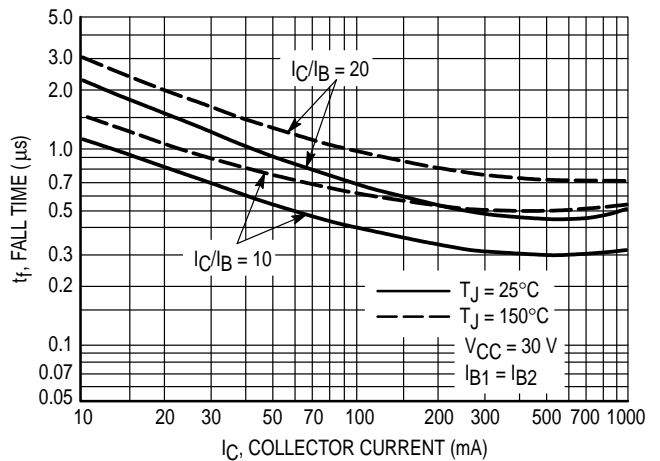

Figure 7. Fall Time

2N4921 thru 2N4923

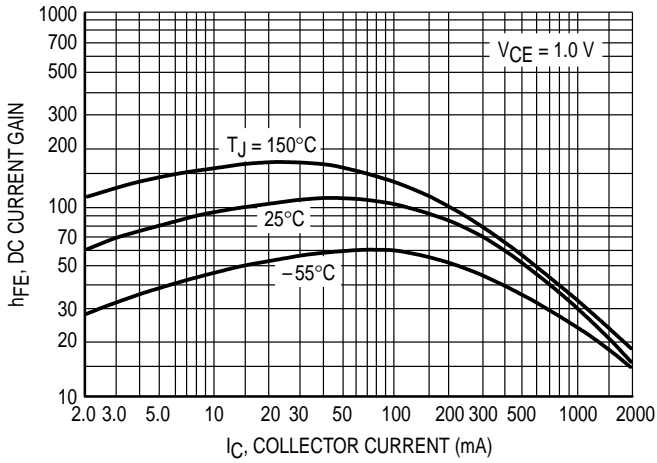

Figure 8. Current Gain

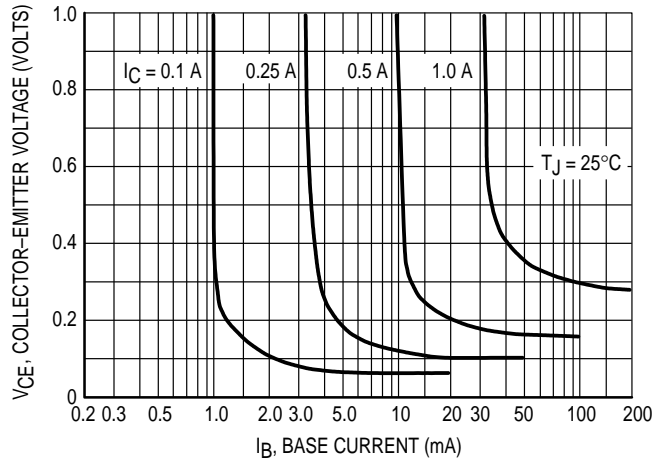

Figure 9. Collector Saturation Region

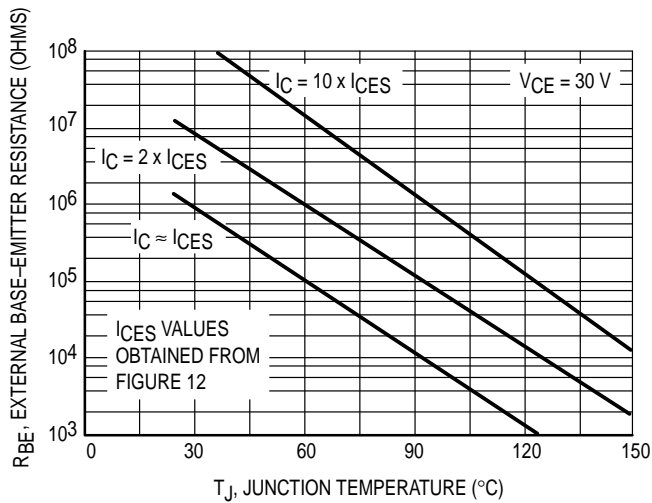

Figure 10. Effects of Base-Emitter Resistance

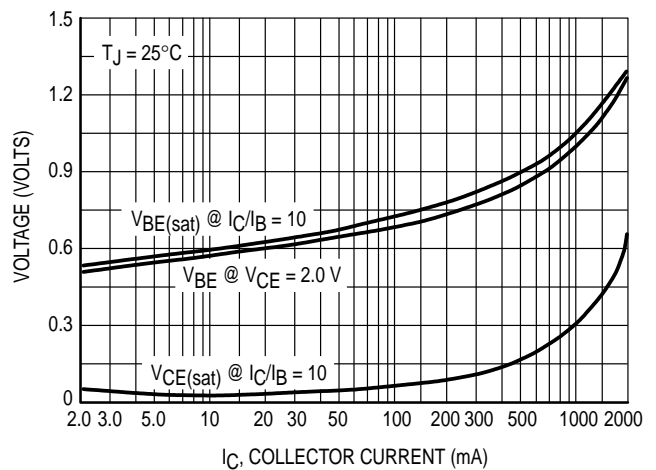

Figure 11. "On" Voltage

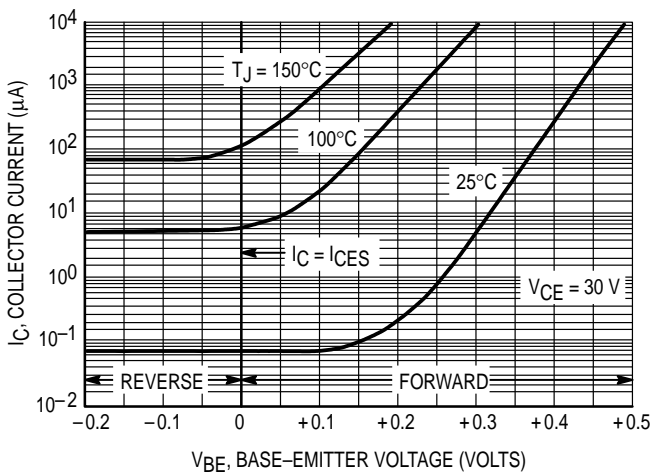

Figure 12. Collector Cut-Off Region

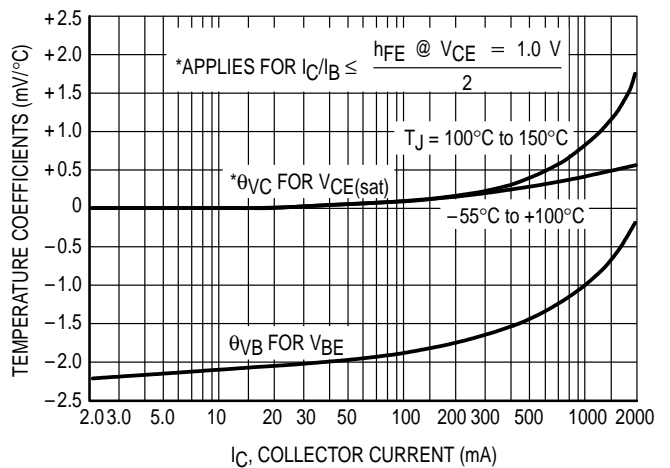
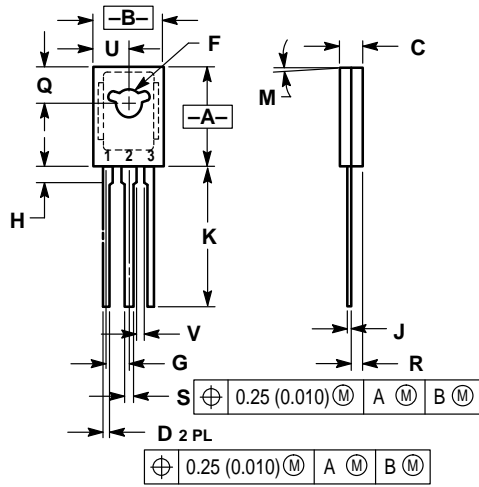

Figure 13. Temperature Coefficients

PACKAGE DIMENSIONS



- NOTES:
 1. DIMENSIONING AND TOLERANCING PER ANSI Y14.5M, 1982.
 2. CONTROLLING DIMENSION: INCH.

DIM	INCHES		MILLIMETERS	
	MIN	MAX	MIN	MAX
A	0.425	0.435	10.80	11.04
B	0.295	0.305	7.50	7.74
C	0.095	0.105	2.42	2.66
D	0.020	0.026	0.51	0.66
F	0.115	0.130	2.93	3.30
G	0.094 BSC		2.39 BSC	
H	0.050	0.095	1.27	2.41
J	0.015	0.025	0.39	0.63
K	0.575	0.655	14.61	16.63
M	5° TYP		5° TYP	
Q	0.148	0.158	3.76	4.01
R	0.045	0.055	1.15	1.39
S	0.025	0.035	0.64	0.88
U	0.145	0.155	3.69	3.93
V	0.040	—	1.02	—

- STYLE 1:
 PIN 1. EMITTER
 2. COLLECTOR
 3. BASE

CASE 77-08
 TO-225AA TYPE
 ISSUE V

Motorola reserves the right to make changes without further notice to any products herein. Motorola makes no warranty, representation or guarantee regarding the suitability of its products for any particular purpose, nor does Motorola assume any liability arising out of the application or use of any product or circuit, and specifically disclaims any and all liability, including without limitation consequential or incidental damages. "Typical" parameters can and do vary in different applications. All operating parameters, including "Typicals" must be validated for each customer application by customer's technical experts. Motorola does not convey any license under its patent rights nor the rights of others. Motorola products are not designed, intended, or authorized for use as components in systems intended for surgical implant into the body, or other applications intended to support or sustain life, or for any other application in which the failure of the Motorola product could create a situation where personal injury or death may occur. Should Buyer purchase or use Motorola products for any such unintended or unauthorized application, Buyer shall indemnify and hold Motorola and its officers, employees, subsidiaries, affiliates, and distributors harmless against all claims, costs, damages, and expenses, and reasonable attorney fees arising out of, directly or indirectly, any claim of personal injury or death associated with such unintended or unauthorized use, even if such claim alleges that Motorola was negligent regarding the design or manufacture of the part. Motorola and  are registered trademarks of Motorola, Inc. Motorola, Inc. is an Equal Opportunity/Affirmative Action Employer.

How to reach us:

USA / EUROPE: Motorola Literature Distribution;
P.O. Box 20912; Phoenix, Arizona 85036. 1-800-441-2447

JAPAN: Nippon Motorola Ltd.; Tatsumi-SPD-JLDC, Toshikatsu Otsuki,
6F Seibu-Butsuryu-Center, 3-14-2 Tatsumi Koto-Ku, Tokyo 135, Japan. 03-3521-8315

MFAX: RMFAX0@email.sps.mot.com – TOUCHTONE (602) 244-6609
INTERNET: <http://Design-NET.com>

HONG KONG: Motorola Semiconductors H.K. Ltd.; 8B Tai Ping Industrial Park,
51 Ting Kok Road, Tai Po, N.T., Hong Kong. 852-26629298

